

Model: 911 78**Model life 1978>>1983**

ORDER-INFO

THIS PARTS CATALOGUE CONTAINS ALL ORDER INFORMATION OF
TYPE 911 FROM MODEL YEAR 1978 TO MODEL YEAR 1983

IT IS AVAILABLE IN TWO EDITIONS IN THE FOLLOWING LANGUAGES:

EDITION

USA, CANADA - *

EDITION

ALL OTHER COUNTRIES - GERMAN

* - ENGLISH

- FRENCH

- ITALIAN

- SPANISH

UPDATING IS BEING PERFORMED BY CHANGING OF UPDATE.

THE EDITION CAN BE RECOGNIZED BY THE CURRENT NO.
YEAR IN THE BOTTOM LINE OF SUBJECT UPDATE.

THE PREVIOUS UPDATE SHOULD NO LONGER BE USED.

ALL ILLUSTRATIONS ARE SUBJECT TO CHANGE WITHOUT OBLIGATION.

"WE RESERVE THE RIGHT TO SUPPLY A SUBSEQUENTLY
PRODUCED COMPONENT, ON WHICH ADDITIONAL WORK
IS NECESSARY, INSTEAD OF THE COMPONENT LISTED IN
THE CATALOGUE"

Model: 911 78**Model life 1978>>1983**

ALL ILLUSTRATIONS ARE SUBJECT TO
CHANGE WITHOUT OBLIGATION.

Model: 911 78 Model life 1978>>1983

SUMMARY TYPES

VEHICLE TYPE	MY	VIN	ENGINE TYPE
911 SC COUPE	78 8	91183 00001>10000	930.03/13 132KW
911 SC TARGA	78 8	91183 10001>>	930.03/13 132KW
911 TURBO	78 8	93087 00001>>	930.60 221KW
911 SC COUPE (USA)(CDN)(CAL)	78 8	91182 00001>10000	930.04/06 132KW
911 SC TARGA (USA)(CDN)(CAL)	78 8	91182 10001>>	930.04/06 132KW
911 TURBO (USA)(CDN)(CAL)	78 8	93088 00001>>	930.61/63 195KW
911 SC COUPE (J)	78 8	91183 09501>19500	930.05/15 132KW
911 SC TARGA (J)	78 8	91183 19501>>	930.05/15 132KW
911 TURBO (J)	78 8	93087 09501>>	930.62 195KW
911 SC COUPE	79 9	91193 00001>10000	930.03/13 132KW
911 SC TARGA	79 9	91193 10000>>	930.03/13 132KW
911 TURBO	79 9	93097 00001>>	930.60 221KW
911 SC COUPE (USA)(CDN)(CAL)	79 9	91192 00001>10000	930.04/06 132KW
911 SC TARGA (USA)(CDN)(CAL)	79 9	91192 10001>>	930.04/06 132KW
911 TURBO (USA)(CDN)(CAL)	79 9	93098 00001>>	930.64/63 195KW
911 SC COUPE (J)	79 9	91193 09501>>	930.05/15 132KW
911 SC TARGA (J)	79 9	91193 19501>>	930.05/15 132KW
911 TURBO (J)	79 9	93097 09501>>	930.65 195KW
911 SC	80 A	91A01 30001>39999	930.09/19 138KW
911 TURBO	80 A	93A00 70001>79999	930.60 221KW
911 SC (USA)(CDN)	80 A	91A01 40001>49999	930.07 132KW
911 SC (J)	80 A	91A01 30001>39999	930.08 132KW
911 TURBO (J)	80 A	93A00 70001>79999	930.65 195KW
911 SC COUPE	81 B	91BS1 00001>05000	930.10 150KW
911 SC TARGA	81 B	91BS1 40001>45000	930.10 150KW
911 TURBO	81 B	93BS0 00001>02000	930.60 221KW
911 SC COUPE (USA)(CDN)	81 B	91BS1 20001>25000	930.16 132KW
911 SC TARGA (USA)(CDN)	81 B	91BS1 60001>65000	930.16 132KW
911 TURBO (CDN)	81 B	93BS0 50001>52000	930.60 221KW
911 SC COUPE (J)	81 B	91BS1 29500>29999	930.17 132KW
911 SC TARGA (J)	81 B	91BS1 69500>69999	930.17 132KW
911 SC COUPE	82 C	91CS1 00001>05000	930.10 150KW
911 SC TARGA	82 C	91CS1 40001>45000	930.10 150KW
911 TURBO	82 C	93CS0 00001>02000	930.60 221KW
911 SC COUPE (USA)(CDN)	82 C	91CS1 20001>25000	930.16 132KW
911 SC TARGA (USA)(CDN)	82 C	91CS1 60001>65000	930.16 132KW
911 TURBO (CDN)	82 C	93CS0 50001>52000	930.60 221KW
911 SC COUPE (J)	82 C	91CS1 09500>09999	930.17 132KW
911 SC TARGA (J)	82 C	91CS1 49500>49999	930.17 132KW
911 SC COUPE	83 D	91DS1 00001>05000	930.10 150KW
911 SC TARGA	83 D	91DS1 40001>45000	930.10 150KW
911 SC CABRIO	83 D	91DS1 50001>55000	930.10 150KW
911 TURBO	83 D	93DS0 00001>02000	930.66 221KW
911 SC COUPE (USA)(CDN)	83 D	91DS1 20001>25000	930.16 132KW
911 SC TARGA (USA)(CDN)	83 D	91DS1 60001>65000	930.16 132KW
911 SC CABRIO (USA)(CDN)	83 D	91DS1 70001>75000	930.16 132KW
911 TURBO (CDN)	83 D	93DS0 50001>52000	930.66 221KW
911 SC (J)	83 D	91DS1 09501>09999	930.17 132KW
911 SC TARGA (J)	83 D	91DS1 49501>49999	930.17 132KW

Model: 911 78

Model life 1978>>1983

911 SC CABRIO (J)

83 D 91DS1 59501>59999 930.17

132KW

Model: 911 78

Model life 1978>>1983

EXPL. ENGINE-NO.

EXPLANATION OF THE MOTOR-NUMBERS USED IN THE CATALOGUE

--->MOD.81
=====

DIGIT:	1 2 3	4 5 6 7
EXAMPLE:	6 3 1	0 2 5 3
	= = =	=====
	! ! !	!
ENGINE TYPE (6 = 6-CYL.-ENGINE)-----+	! !	!
	! !	!
ENGINE VERSION-----+	!	!
	!	!
MODEL YEAR-----+		!
		!
SERIAL NUMBER-----+		!

MOD.82--->
=====

DIGIT:	1 2 3	4 5 6 7 8
EXAMPLE:	6 3 D	0 2 5 3 4
	= = =	=====
	! ! !	!
ENGINE TYPE (6 = 6-CYL.-ENGINE)-----+	! !	!
	! !	!
ENGINE VERSION-----+	!	!
	!	!
MODEL YEAR-----+		!
		!
SERIAL NUMBER-----+		!

Model: 911 78

Model life 1978>>1983

SUMMARY ENGINES

VEHICLE TYPE	ENGINE		ENGINE NO.	TECHNICAL DATA
	TYPE	MY		
911 SC	930.03	78 8	638 0001>9000	6-ZYL/3,0L/132KW
911 SC SPM	930.13	78 8	638 9001>>	6-ZYL/3,0L/132KW
911 TURBO	930.60	78 8	678 0001>>	6-ZYL/3,3L/221KW
911 SC (USA)(CDN)	930.04	78 8	628 0001>>	6-ZYL/3,0L/132KW
911 TURBO (USA)(CDN)	930.61	78 8	688 0001>>	6-ZYL/3,3L/195KW
911 SC (CAL)	930.06	78 8	658 0001>>	6-ZYL/3,0L/132KW
911 TURBO (CAL)	930.63	78 8	688 1001>>	6-ZYL/3,3L/195KW
911 SC (J)	930.05	78 8	618 0001>9000	6-ZYL/3,0L/132KW
911 SC SPM	930.15	78 8	618 9001>>	6-ZYL/3,0L/132KW
911 TURBO	930.62	78 8	678 2001>>	6-ZYL/3,3L/195KW
911 SC	930.03	79 9	639 0001>9000	6-ZYL/3,0L/132KW
911 SC SPM	930.13	79 9	639 9001>>	6-ZYL/3,0L/132KW
911 TURBO	930.60	79 9	679 0001>>	6-ZYL/3,3L/221KW
911 SC (USA)(CDN)	930.04	79 9	629 0001>>	6-ZYL/3,0L/132KW
911 TURBO (USA)(CDN)	930.64	79 9	689 0001>>	6-Z>L/3,3L/195KW
911 SC (CAL)	930.06	79 9	659 0001>>	6-ZYL/3,0L/132KW
911 TURBO (CAL)	930.63	79 9	689 1001>2000	6-ZYL/3,3L/195KW
911 SC (J)	930.05	79 9	619 0001>9000	6-ZYL/3,0L/132KW
911 SC SPM	930.15	79 9	619 9001>>	6-ZYL/3,0L/132KW
911 TURBO (J)	930.65	79 9	679 1001>2000	6-ZYL/3,3L/195KW
911 SC	930.09	80 A	630 0001>8000	6-ZYL/3,0L/138KW
911 SPM	930.19	80 A	630 9001>9999	6-ZYL/3,0L/138KW
911 TURBO	930.60	80 A	670 0001>1000	6-Z>L/3,3L/221KW
911 SC (USA)(CDN)	930.07	80 A	640 0001>9999	6-ZYL/3,0L/132KW
911 SC (J)	930.08	80 A	630 8001>9000	6-ZYL/3,0L/132KW
911 TURBO (J)	930.65	80 A	670 8001>9000	6-ZYL/3,3L/195KW
911 SC	930.10	81 B	631 0001>8000	6-ZYL/3,0L/150KW
911 TURBO	930.60	81 B	671 0001>1000	6-ZYL/3,3L/221KW
911 SC (USA)(CDN)	930.16	81 B	641 0001>9999	6-ZYL/3,0L/132KW
911 TURBO (CDN)	930.60	81 B	671 0001>1000	6-ZYL/3,3L/221KW
911 SC (J)	930.17	81 B	631 8001>9000	6-ZYL/3,0L/132KW
911 SC	930.10	82 C	63C 0001>8000	6-ZYL/3,0L/150KW
911 TURBO	930.60	82 C	67C 0001>1000	6-ZYL/3,3L/221KW
911 SC (USA)(CDN)	930.16	82 C	64C 0001>9999	6-ZYL/3,0L/132KW
911 TURBO (CDN)	930.60	82 C	67C 0001>1000	6-ZYL/3,3L/221KW
911 SC	930.17	82 C	63C 8001>9000	6-ZYL/3,0L/132KW
911 SC	930.10	83 D	63D 0001>8000	6-ZYL/3,0L/150KW
911 TURBO	930.66	83 D	67D 0001>1000	6-ZYL/3,3L/221KW
911 SC (USA)(CDN)	930.16	83 D	64D 0001>9999	6-ZYL/3,0L/132KW
911 TURBO (CDN)	930.66	83 D	67D 0001>1000	6-ZYL/3,3L/221KW
911 SC (J)	930.17	83 D	63D 8001>9000	6-ZYL/3,0L/132KW

Model: 911 78

Model life 1978>>1983

EXPL. TRANSM. NO.

EXPLANATION OF THE TRANSMISSION-NUMBERS USED IN THE CATALOGUE

=====

--->MOD. 81

=====

DIGIT:		1	2	3		4	5	6	7
EXAMPLE:		7	3	1		0	3	5	5
		=	=	=		=	=	=	=
		!	!	!		!			
TRANSMISSION TYPE-----	+	!	!			!			
		!	!			!			
TRANSMISSION VERSION-----	+	!				!			
		!				!			
MODEL YEAR-----	+					!			
						!			
SERIAL NUMBER-----	+								

MOD. 82--->

=====

DIGIT:		1	2	3		4	5	6	7	8
EXAMPLE:		7	3	D		0	2	5	3	4
		=	=	=		=	=	=	=	=
		!	!	!		!				
TRANSMISSION TYPE-----	+	!	!			!				
		!	!			!				
TRANSMISSION VERSION-----	+	!				!				
		!				!				
MODEL YEAR-----	+					!				
						!				
SERIAL NUMBER-----	+									

Model: 911 78

Model life 1978>>1983

SUMM. TRANSMISS.

VEHICLE TYPE	TRANSM.			TRANSMISSION NO.	TECHNICAL DATA
	TYPE	MY			
911 SC	915.61	78 8	718	0001>>	5-SPEED
911 SC SPM	925.16	78 8	768	0001>>	3-SPEED
911 TURBO	930.34	78 8	778	0001>>	4-SPEED
911 SC	915.61	79 9	719	0001>>	5-SPEED
911 SC SPM	925.16	79 9	769	0001>>	3-SPEED
911 TURBO	930.34	79 9	779	0001>>	4-SPEED
911 SC	915.62	80 A	730	0001>9999	5-SPEED
911 SC SPM	925.16	80 A	760	0001>2000	3-SPEED
911 TURBO	930.34	80 A	770	0001>2000	4-SPEED
911 SC (USA) (CDN)	915.63	80 A	740	0001>9999	5-SPEED
911 SC (J)	915.62	80 A	730	0001>9999	5-SPEED
911 SC	915.62	81 B	731	0001>9999	5-SPEED
911 TURBO	930.34	81 B	771	0001>2000	4-SPEED
911 SC (USA) (CDN)	915.63	81 B	741	0001>9999	5-SPEED
911 SC	915.62	82 C	73C	0001>9999	5-SPEED
911 TURBO	930.34	82 C	77C	0001>2000	4-SPEED
911 SC (USA) (CDN) (J)	915.63	82 C	74C	0001>9999	5-SPEED
911 SC	915.62	83 D	73D	0001>9999	5-SPEED
911 TURBO	930.34	83 D	77D	0001>2000	4-SPEED
911 SC (USA) (CDN) (J)	915.63	83 D	74D	0001>9999	5-SPEED

Model: 911 78

Model life 1978>>1983

LEGENDS/NOTICES

LEGENDS AND NOTICES

=====

IN COLUMN -S- STATUS

- N NEW ADDITION
- P PART ALREADY IN PROGRAMME, BUT NEW AT THIS APPLICATION
- W DELETED AT THIS APPLICATION, BUT CONTINUED TO BE CARRIED
- A STOCK TO BE USED UP
- U DELETED WITHOUT REPLACEMENT
- * PART ALSO OR ONLY AVAILABLE IN REPAIR KIT
- > ALSO AVAILABLE IN EXCHANGE

IN COLUMN - ILL. -

- 1 IDENTIFICATION NO. IN ILLUSTRATION
- (1) PART ONLY SIMILAR AS ILLUSTRATED
- PART IS NOT ILLUSTRATED

FIG.-NUMBERS FOR WHICH THERE IS SHOWN NO TEXT ARE NOT VALID FOR THIS EDITION OF CATALOGUE

IN COLUMN -PART NUMBER/CODE-

000 000 000 00 PART NUMBER EQUALS ORDERING NO., IF A CODE IS SHOWN, IT WILL HAVE TO BE PART OF ORDERING NUMBER

AC3 COLOUR CODE

IN COLUMN -TEXT

INSTALLATION WIRH ENGINE OR CHASSIS NUMBER-RANGE

EXAMPLE:

M 63D 01291 >> FROM ENGINE NO.

Model: 911 78**Model life 1978>>1983**

F >> 91 DS1 01291 UP TO VIN

Model: 911 78

Model life 1978>>1983

LEGENDS/NOTICES

IN COLUMN - A -

IDENTIFICATION LETTER FOR PERIOD OF INSTALLATION
THAT IS REPEATED SEVERAL TIMES IN THE CATALOG GROUP.

EXPLANATION PLEASE FIND IN TEXT COLUMN OF THE CATALOG GROUP

IN COLUMN - QU - = NO. OF PIECES

1 NUMBER PER APPLICATION

X NUMBER AS NEEDED

* AVAILABLE ONLY IN RUNNING LENGTHS 1 = 1 METRE

IN COLUMN - MODEL/SYMBOL -

M650 OPTIONAL EQUIPMENT - SEE M-NO. LIST

-83 LIMITATION OF MODEL YEAR FOR INSTANCE: VALID UP TO
END OF MODEL YEAR 1983

/LL LHD

/RL RHD

/V FRONT I
I

/H REAR I

/L LEFT I I----> APPLIES TO
DIRECTION OF TRAVEL

/R RIGHT I

-----+

SPM SPORTOMATIC

WW THE PART CAN BE USED INSTEAD OF THE
PRECEDING ONE

Model: 911 78

Model life 1978>>1983

COUNTRY-EQIPM.

EQUIPMENT BY COUNTRY REGULATIONS

=====

(A)	AUSTRIA
(AUS)	AUSTRALIA
(B)	BELGIUM
(CDN)	CANADA
(CH)	SWITZERLAND
(D)	FEDERAL REPUBLIC OF GERMANY
(DK)	DENMARK
(E)	SPAIN
(F)	FRANCE
(GB)	GREAT BRITAIN
(GR)	GREECE
(HK)	HONGKONG
(I)	ITALY
(J)	JAPAN
(L)	LUXEMBURG
(N)	NORWAY
(NL)	NETHERLANDS
(NS)	NEW ZEALAND
(P)	PORTUGAL
(RS)	TAIWAN
(S)	SWEDEN
(SA)	SAUDI ARABIA
(SF)	FINLAND
(USA)	UNITED STATES OF AMERICA

Model: 911 78

Model life 1978>>1983

NR	Description
M000	+-----+ ! Summary of optional extras "M"! +-----+
M009	3-speed Sportomatic transmission
M020	Speedometer with two scales mph-km/h
M026	With activated charcoal canister
M027	Version for California
M058	Impact absorbers, front and rear
M062	Version for Sweden
M113	Version for Canada
M124	Version for France
M157	Version for USA oxygen-sensor, three-way catalytic converter
M185	Three-point belt, belt-lock with cables, for driver's seat only and two-point belt, rear
M186	2-point seat belts, rear manual
M187	Headlamps with sealed-beam insert "asymmetric"
M190	Increased side door strength
M193	Version for Japan
M197	Stronger battery
M215	Version for Saudi Arabia
M220	Locking differential 40 %
M261	Door mirror - flat - passenger's side, electrically adjustable and heatable
M288	Headlamp washer
M395	Light-alloy rims, forged front 6J x 16 with tyres 205/55 VR16 rear 7J x 16 with tyres 225/50 VR16
M399	Air conditioner without front condenser 78
M401	Light-alloy rims, forged 15-inch
M403	911-SC-anniversary car 82 50 years of Porsche designs Exterior colour: Meteor Metallic Interior equipment: Burgundy
M409	Sports seats, leather
M410	Sports seats, seat and backrest surface cloth/leatherette
M424	Automatic heating control
M425	Rear window wiper
M439	Special model 80
M443	Tinted windscreen glass and tinted side-window glass with electrically

Model: 911 78

Model life 1978>>1983

NR	Description
	heatable windscreen, 1-stage
M444	Cabrio
M454	Automatic speed control
M467	Door mirror for driver's side, convex, electrically heatable and adjustable
M469	Black roofliner
M473	With front spoiler and rear spoiler
M474	Shock absorber (sporting), front and rear
M479	Version for Australia
M482	Engine compartment light
M483	Differing engine parts for right-hand drive
M484	Symbols and lettering for switches and instruments
M492	Headlamps for left-hand traffic
M494	2 loudspeakers on parcel shelf
M496	Preparation for Philips telephone "C" network
M499	Version for Germany
M525	Anti-theft device with continuous sound
M528	Door mirror for passenger's side - convex - electrically heatable and adjustable
M533	Anti-theft device
M553	Version for USA, Canada
M559	Air conditioner
M566	Front fog lights, white
M567	Windscreen tinted, upper part darker coloured
M568	Tinted side windows and tinted windscreen
M573	Air conditioner with heavy duty blower
M592	Brake fluid level indicator
M650	Electrical sliding roof
M981	Leather equipment

Model: 911 78

Model life 1978>>1983

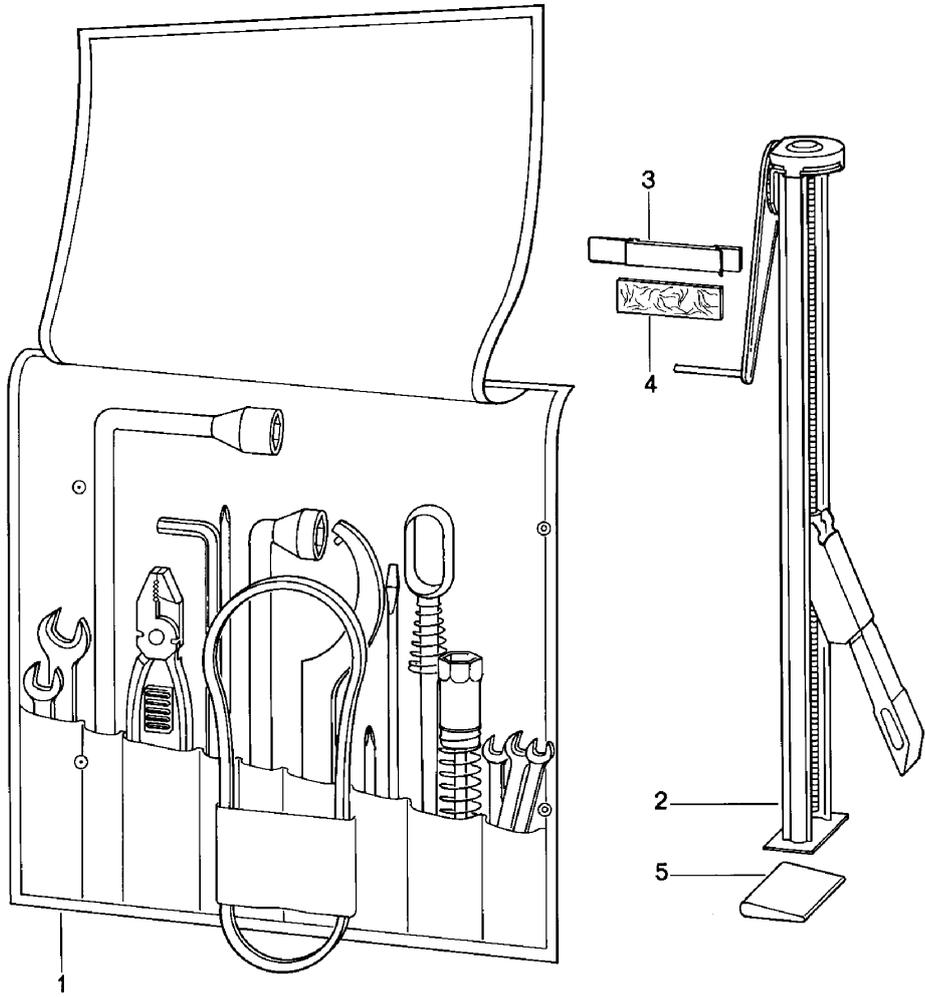

Model: 911 78 Model life 1978>>1983

Pos	Part Number	Description	Remark	Qty	Model
1	911 721 002 04	Accessories Stickers Tool bag with contents Comprising:	-79	1	SC
-	999 571 045 02	Tool bag		1	
-	999 195 011 02	Rim wrench		1	
-	999 195 012 02	Double-end spanner 8 X 9		1	
-	999 195 012 02	Double-end spanner 10 X 11		1	
-	999 195 007 02	Double-end spanner 12 X 13		1	
-	999 195 014 02	Double-end spanner 14 X 15		1	
-	999 195 015 02	Double-end spanner 17 X 19		1	
-	999 205 003 02	Tool		1	
-	999 107 003 02	Universal pliers		1	
-	999 192 097 50	Narrow v-belt 9,5 x 725		1	
-	911 721 013 00	Bag with Lock		1	
-	999 571 047 02	Tool		5	
-	477 012 203 A	V-belt pulley		1	
-	477 012 203 A	Spark plug wrench		1	
-	477 012 227	Spark plug wrench		1	
-	477 012 227	Angular screw driver		1	
-	911 721 051 00	Towing lug		1	
-	911 721 107 02	Screwdriver		1	
(1)	911 721 002 08	Tool with contents Comprising:	80-	1	
-	477 012 203 A	Tool bag		1	
-	477 012 203 A	Spark plug wrench		1	
-	477 012 227	Angular screw driver		1	
-	900 066 004 02	Screwdriver		1	
-	999 571 045 02	Rim wrench		1	
-	999 195 011 02	Double-end spanner 8 X 9		1	
-	999 195 012 02	Double-end spanner 10 X 11		1	
-	999 195 013 02	Double-end spanner 12 X 13		1	
-	999 195 015 02	Double-end spanner 17 X 19		1	
-	999 195 014 02	Double-end spanner 14 X 15		1	
-	999 205 003 02	Tool		1	
-	911 721 107 02	Screwdriver		1	
-	999 107 003 02	Universal pliers		1	
-	999 192 176 50	Narrow v-belt 9,5 X 710		1	
-	999 192 176 5A	Narrow v-belt 9,5 X 710		1	
-	911 721 051 00	Towing lug		1	
-	911 721 013 00	Bag with Lock		1	
-	911 721 231 00	Angular screw driver		5	
-	911 721 235 00	Extension rod		1	
-	999 571 047 02	Tool		1	

Model: 911 78

Model life 1978>>1983

Pos	Part Number	Description	Remark	Qty	Model
(1)	911 721 002 10	Pulley Tool with contents Comprising: Tool bag	82	1	
-	477 012 203 A	Spark plug wrench		1	
-	477 012 227	Angular screw driver		1	
-	900 066 004 02	Screwdriver		1	
-	999 571 045 02	Rim wrench		1	
-	999 195 011 02	Double-end spanner 8 X 9		1	
-	999 195 012 02	Double-end spanner 10 X 11		1	
-	999 195 013 02	Double-end spanner 12 X 13		1	
-	999 195 015 02	Double-end spanner 17 X 19		1	
-	999 195 014 02	Double-end spanner 14 X 15		1	
-	999 571 046 02	Tool		1	
-	911 721 107 02	Screwdriver		1	
-	999 107 004 02	Universal pliers		1	
-	999 192 176 50	Narrow v-belt 9,5 X 710		1	
-	999 192 176 5A	Narrow v-belt 9,5 X 710		1	
-	911 721 013 00	Bag with Lock		1	
-	911 721 231 00	Angular screw driver		5	
-	911 721 235 00	Extension rod		1	
-	999 571 047 02	Tool Pulley		1	
-	911 721 051 00	Towing lug		1	
(1)	911 721 002 12	Tool bag with contents Comprising: Tool bag	83-	1	
(1)	911 721 002 14	Tool with contents Comprising: Tool bag without Towing lug 99672115100	83-	1	
-	477 012 203 A	Spark plug wrench		1	
-	477 012 227	Angular screw driver		1	
-	900 066 004 02	Screwdriver		1	
-	999 571 045 02	Rim wrench SW 19		1	
-	999 195 011 02	Double-end spanner 8 X 9		1	
-	999 195 012 02	Double-end spanner 10 X 11		1	
-	999 195 013 02	Double-end spanner 12 X 13		1	
-	999 195 015 02	Double-end spanner 17 X 19		1	
-	999 195 006 02	Double-end spanner 14 X 15		1	
-	999 571 046 02	Tool SW 24		1	
-	911 721 107 02	Screwdriver		1	

Model: 911 78 Model life 1978>>1983

Pos	Part Number	Description	Remark	Qty	Model
-	999 107 004 02	Universal pliers		1	
-	999 192 176 50	Narrow v-belt		1	
-	999 192 176 5A	Narrow v-belt		1	
-	911 721 013 00	Bag with Lock		1 5	
-	911 721 231 00	Angular screw driver		1	
-	911 721 235 00	Extension rod		1	
-	999 571 047 02	Tool Pulley		1	
-	996 721 151 00	Towing lug		1	
(1)	911 721 002 09	Tool with contents Comprising: Tool bag	-81	1	
-	477 012 203 A	Spark plug wrench		1	
-	477 012 227	Angular screw driver		1	
-	900 066 004 02	Screwdriver		1	
-	999 571 045 02	Rim wrench		1	
-	999 195 011 02	Double-end spanner 8 X 9		1	
-	999 195 012 02	Double-end spanner 10 X 11		10	
-	999 195 013 02	Double-end spanner 12 X 13		1	
-	999 195 015 02	Double-end spanner 17 X 19		1	
-	999 195 014 02	Double-end spanner 14 X 15		1	
-	999 205 003 02	Tool		1	
-	911 721 107 02	Screwdriver		1	
-	999 107 003 02	Universal pliers		1	
-	999 192 176 50	Narrow v-belt 9,5 X 710		1	
-	999 192 176 5A	Narrow v-belt 9,5 X 710		1	
-	911 721 013 00	Bag with Lock		1 5	
-	911 721 231 00	Angular screw driver		1	
-	911 721 235 00	Extension rod		1	
-	999 571 047 02	Tool Pulley		1	
2	911 721 011 04	Jack		1	
3	911 722 021 01	Bracket for jack		1	
4	911 556 208 02	Felt strip		1	
5	911 721 131 00	Clamping piece		1	
5	911 721 131 01	Clamping piece without Adhesive film Stickers		1	
-	901 701 111 05	Sticker Paint	-80	1	
-	900 093 001 02	T-headed screw Rivet		4	
-	911 701 127 00	Sticker		1	
-	911 701 171 00	Sticker Heating Actuator		1	
-	930 006 501 01	Sticker Ignition point	-82	1	TURBO
-	930 006 501 02	Sticker	83-	1	TURBO

Model: 911 78 Model life 1978>>1983

Pos	Part Number	Description	Remark	Qty	Model
-	901 006 502 00	Ignition point Sticker	-78	1	
-	930 006 509 00	Firing order Sticker	79-	1	
-	930 006 510 00	Firing order Sticker	-80	1	SC
-	930 006 510 01	Ignition point Sticker	81-	1	SC
-	901 006 503 00	Ignition point Sticker		1	
-	911 006 504 01	Valve clearance Sticker	-80	1	TURBO
-	930 006 504 00	Engine oil level Sticker	-80	1	SC
-	930 006 504 02	Engine oil level Sticker	81-	1	
-	901 006 505 01	Engine oil level Sticker		1	SC
-	930 006 505 01	Tyre pressure Sticker		1	TURBO
-	911 701 137 01	Tyre pressure Sticker		1	SC
-	928 701 157 03	Emergency wheel Sticker		1	TURBO
-	911 006 512 13	Emergency wheel Sticker	81-	1	SC
-	911 006 521 03	FUER REIFENDRUCK 6 J X 16 7 J X 16 Sticker	/V /H (AUS)	1	SC
-	911 006 522 06	Tyre pressure Sticker	-79	1	SC
-	911 006 522 10	Tyre pressure 6 J X 16 7 J X 16 Sticker	/V /H (AUS)	1	TURBO
-	930 006 513 03	Tyre pressure Sticker	(AUS) -78	1	SC
-	930 006 513 06	Engine specifications Sticker	(AUS) 79	1	SC
-	930 006 513 11	Engine specifications Sticker	(AUS) 80	1	SC
-	930 006 513 15	Engine specifications Sticker	(AUS) 81	1	SC
-	930 006 513 20	Engine specifications Sticker	(AUS) 82	1	SC
-	930 006 513 24	Engine specifications Sticker	(AUS) 83-	1	SC
-	930 006 535 04	Engine specifications Sticker	(S) -78	1	SC
-	930 006 535 06	Engine specifications Sticker	(S) -80	1	SC
-	930 006 535 09	Engine specifications Sticker	(S) 81-	1	SC
-	930 006 535 05	Engine specifications Sticker	(S) -78	1	TURBO
-	930 006 535 07	Engine specifications Sticker	(S) 79-82	1	M559 TURBO
-	930 006 119 01	Engine specifications Sticker	(S)	1	TURBO
-	930 006 537 00	Engine specifications Sticker	(AUS) -78	1	TURBO

Model: 911 78

Model life 1978>>1983

Pos	Part Number	Description	Remark	Qty	Model
-	930 006 537 04	Sticker Engine specifications	(AUS) 79	1	TURBO
-	930 006 537 09	Sticker Engine specifications	(AUS) 80	1	TURBO
-	930 006 537 10	Sticker Engine specifications	(AUS) 81	1	TURBO
-	930 006 537 11	Sticker Engine specifications	(AUS) 82	1	TURBO
-	930 006 537 13	Sticker Engine specifications	(AUS) 83-	1	TURBO
-	928 006 901 00	Sticker Drawbar load		1	
-	944 701 193 00	Trailer coupling Sticker Wheel nut Emergency wheel		1	

Model: 911 78

Model life 1978>>1983

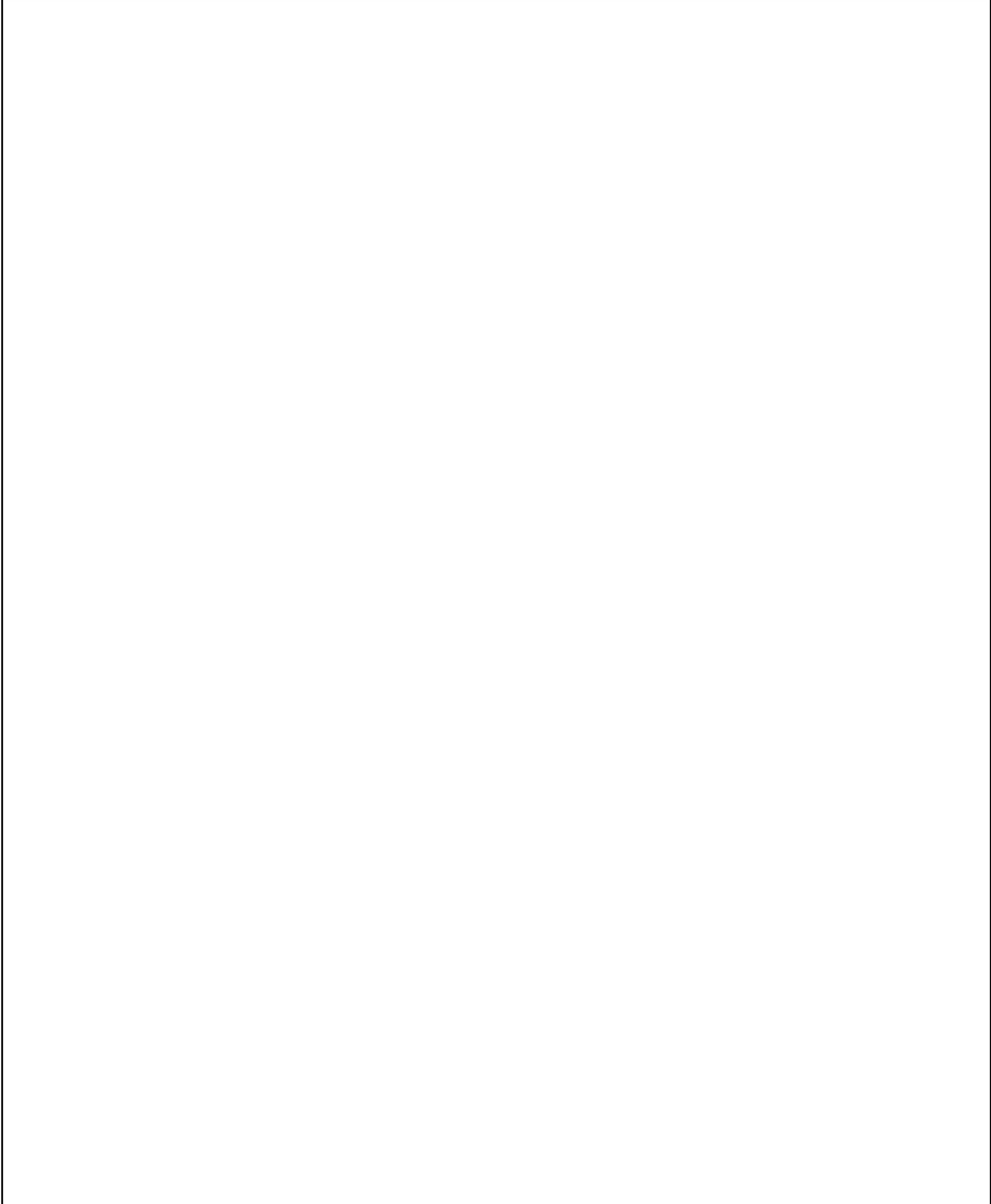

Model: 911 78

Model life 1978>>1983

Pos	Part Number	Description	Remark	Qty	Model
-	911 361 909 00	Accessories Snow chains Trailer coupling Child car seat Vehicle cover Snow chains 1 set for Tyre 185/70 - 15, 215/60 - 15 205/55 - 16, 225/50R 16		1	
-	928 361 047 03	Wheel nut Lockable 1 set		1	
-	965 361 955 00	Wheel nut Lockable 1 set		1	
-	968 361 955 00	Wheel nut Lockable 1 set		1	
-	993 361 057 00	Wheel nut Lockable 1 set		1	
-	928 361 306 03	Wheel nut Lockable without lock		4	
-	928 361 310 00	Cap Roof rack		4	
-	901 801 953 00	Leather strap for Roof rack 1 set		1	COUPE
-	928 801 011 02	Ski rack Cylinder lock with Spring clamp - 2 - Key State lock number		1	COUPE
-	911 722 031 00	Trailer coupling Trailer coupling Vertical seat adjustment		1	SC
-	911 521 493 00	Spacer		X	
-	900 067 089 02	Pan-head screw M 6 X 25 for 13 MM Elevation		X	
-	900 067 089 01	Pan-head screw M 6 X 25 for 13 MM Elevation		X	
-	N 014 749 2	Pan-head screw M 6 X 40 for 26 MM Elevation		X	
-	928 522 050 00	Child car seat Child car seat Older than 4 years Only together with		1	
-	911 522 071 00	Child car seat cushion Child car seat cushion	/L	1	

Model: 911 78 Model life 1978>>1983

Pos	Part Number	Description	Remark	Qty	Model
	911 522 071 00 4CR	Black PORSCHE logo			
-	911 522 072 00	Child car seat cushion	/R	1	
	911 522 072 00 4CR	Black PORSCHE logo			
-	PCG 043 203 01	Cover Porsche crest OHNE SPOILER AUSSENSPIEGEL		1	911
		Left			
-	PCG 043 202 01	Cover Porsche crest Ohne Spoiler Aussenspiegel		1	911
		Left			
		Right			
-	000 043 202 01	Cover Porsche crest Ohne Spoiler Aussenspiegel		1	911
		Left			
		Right			
-	PCG 043 202 02	Cover Porsche crest with spoiler Aussenspiegel		1	911
		Left			
		Right			
-	000 043 202 02	Cover Porsche crest with spoiler Aussenspiegel		1	911
		Left			
		Right			

Model: 911 78

Model life 1978>>1983

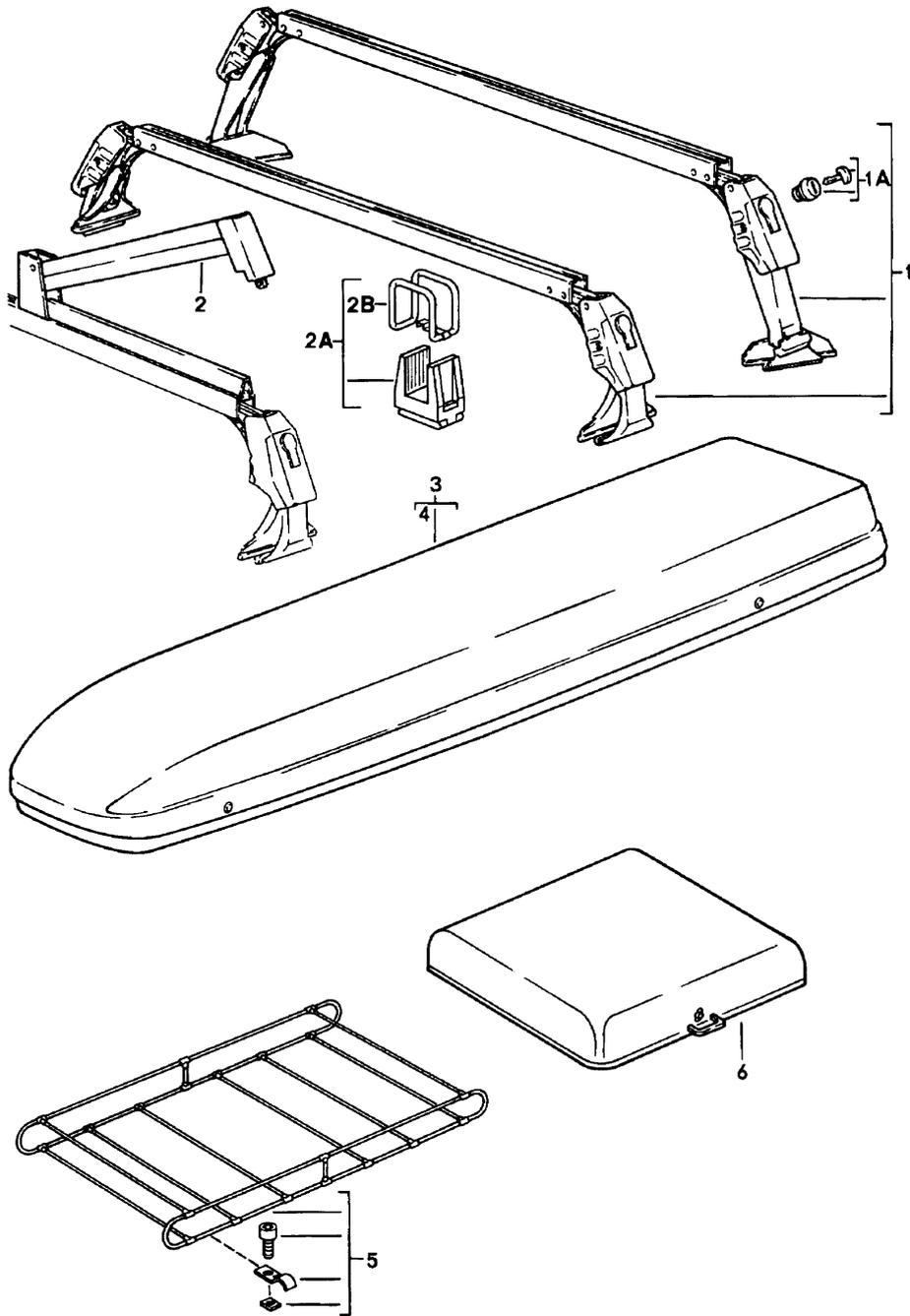

Model: 911 78

Model life 1978>>1983

Pos	Part Number	Description	Remark	Qty	Model
		Roof transport system			
		- 1 -			
1	911 801 055 00	Set of main supports		1	COUPE
(1)	911 801 055 60	Set of main supports		1	TARGA
		35 KG			CABRIO
-	911 801 275 60	Desk pad		2	
		for claw			
-	911 801 273 60	Insert		2	TARGA
-	928 801 111 02	Protection cap		4	
		for			
		Lock			
1A	928 801 011 02	Cylinder lock		1	
		with			
		Spring clamp			
		with			
		- 2 -			
		Key			
		State lock number			
2	928 801 061 02	Clamping bow		1	
		1 set			
2A	928 801 903 02	Rubber support for skis		1	
2B	928 801 193 02	Retaining strap		1	
3	928 801 063 02	Ski box	/L	1	COUPE
(3)	928 801 064 02	Ski box	/R	1	COUPE
5	928 801 081 02	Roof luggage rack set		1	
6	928 801 073 02	Box for suitcase		1	COUPE

Model: 911 78

Model life 1978>>1983

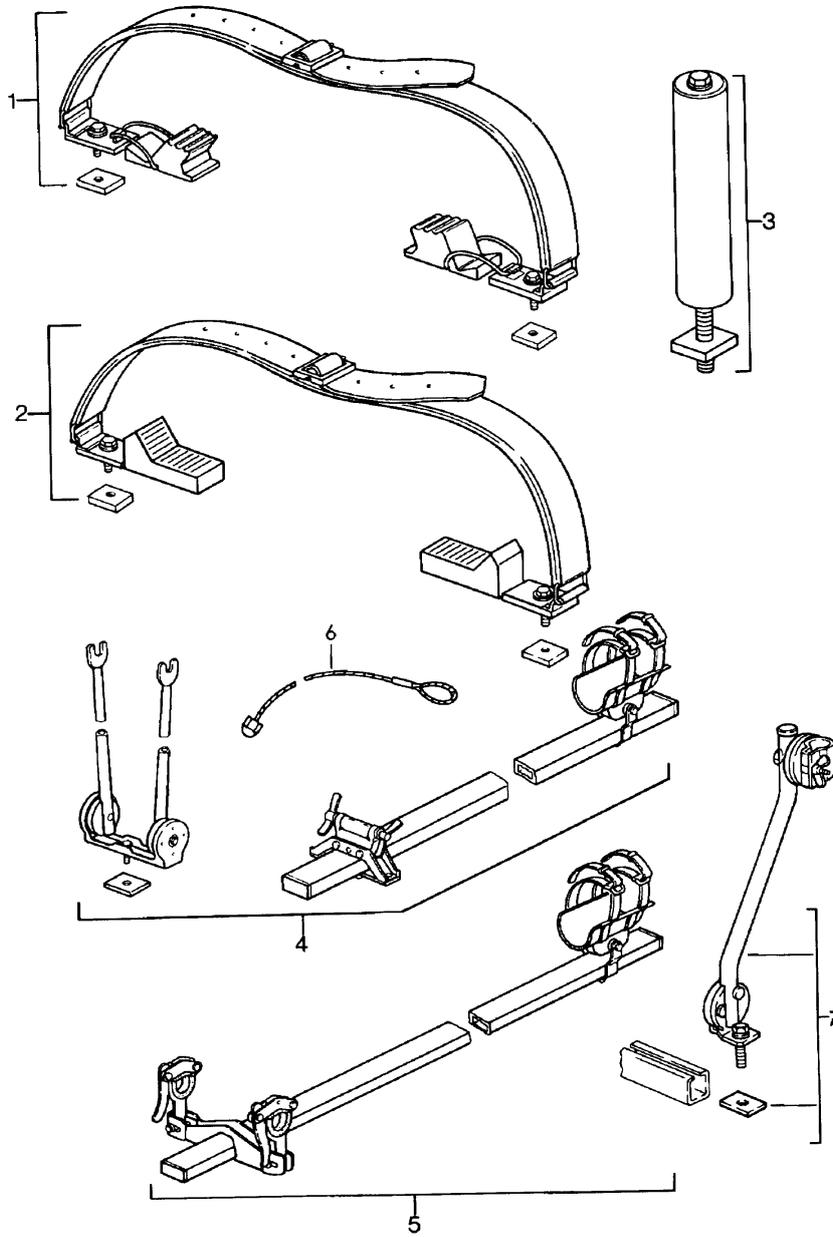

Model: 911 78

Model life 1978>>1983

Pos	Part Number	Description	Remark	Qty	Model
		Roof transport system - 2 -			
1	928 801 019 02	Set of surf board supports		1	COUPE
2	928 801 017 02	Set - canoe carrier		1	
3	928 801 085 02	Ladder support mandrel		X	
4	928 801 093 02	Set - bike carrier for Racing bike		1	
5	928 801 095 02	Set - bike carrier for Standard bike		1	
6	928 801 079 02	Safety rope		1	
7	928 801 097 02	Support for bicycle		1	

Model: 911 78

Model life 1978>>1983

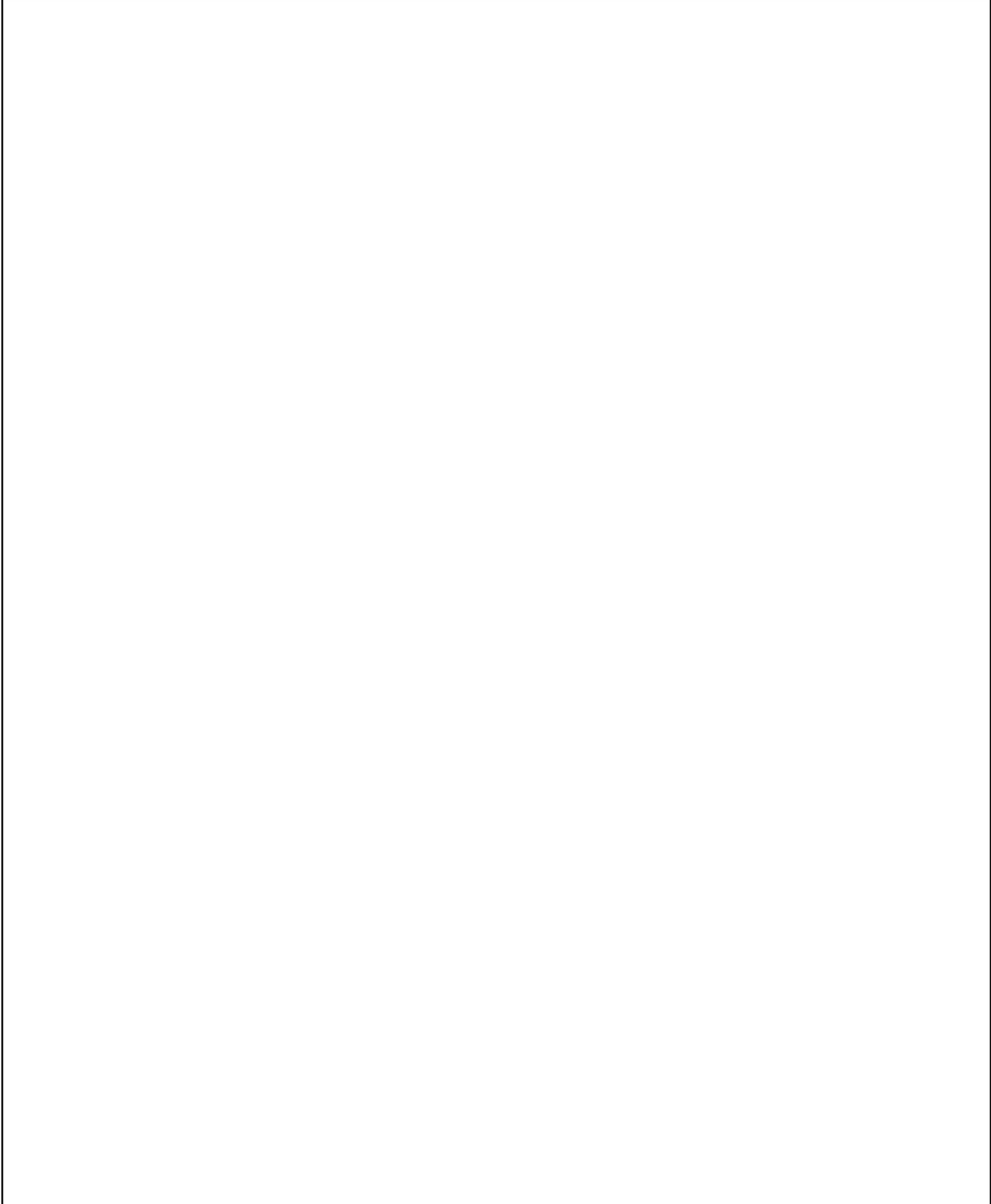

Model: 911 78

Model life 1978>>1983

Pos	Part Number	Description	Remark	Qty	Model
1	PCG 911 211 00	Assembly kit Maintenance set Repair Assembly kit Heat exchanger Comprising:	74-86	1	CARRERA
-	930 111 191 13	Gasket		6	
-	900 076 064 02	Hexagon nut		6	
-	999 085 001 02	Socket head nut		6	
-	900 074 282 02	Screw		9	
-	900 910 097 0C	Lock nut		9	
-	930 111 192 06	Gasket		2	
-	911 111 189 03	Gasket		1	
-	911 111 188 02	Support washer		1	
-	911 111 187 00	Clamp		2	
-	900 074 378 01	Screw		2	
-	900 074 233 02	Screw		2	
-	900 910 096 02	Lock nut		2	
-	930 111 193 07	Gasket		1	

Model: 911 78

Model life 1978>>1983

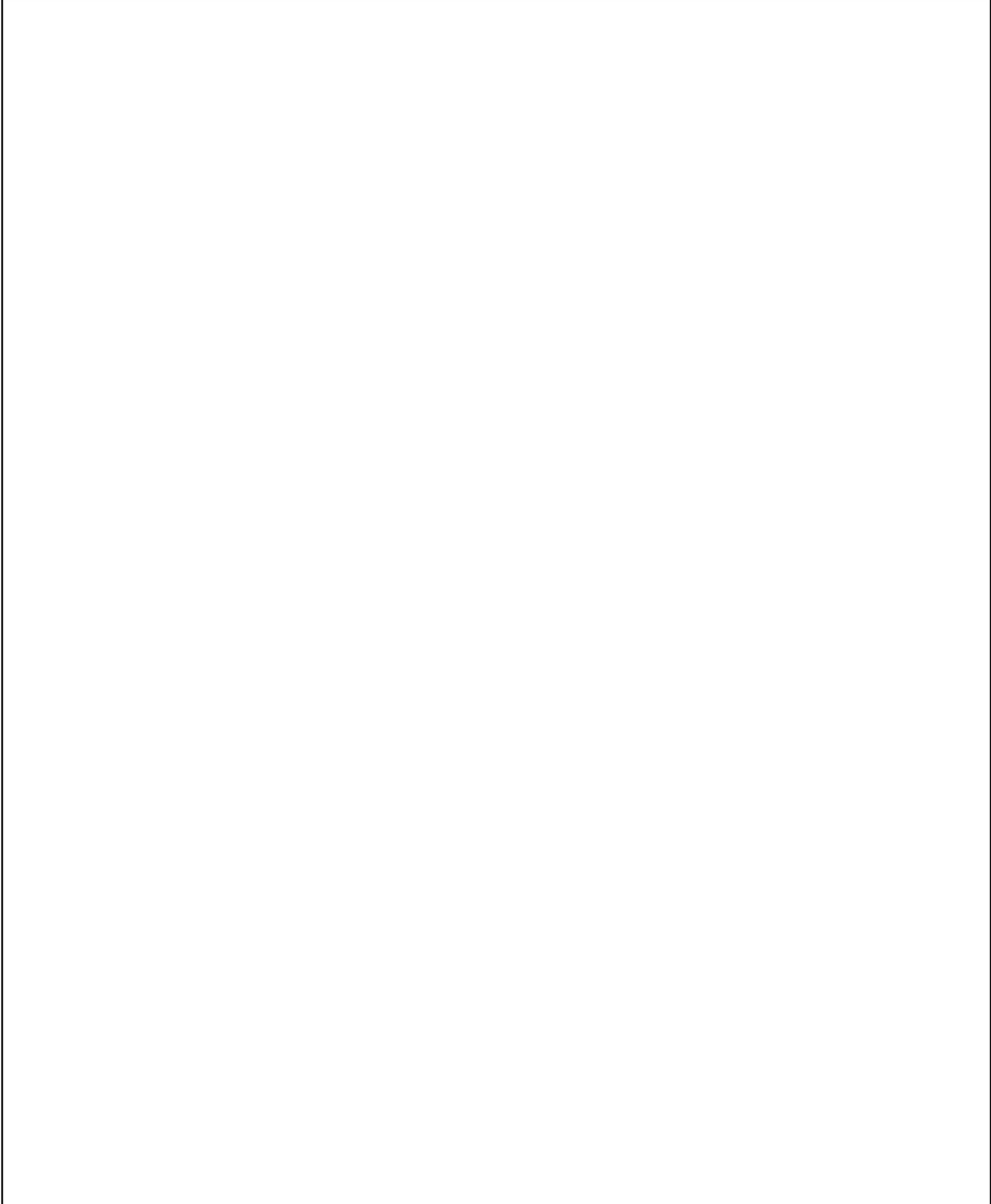

Model: 911 78

Model life 1978>>1983

Pos	Part Number	Description	Remark	Qty	Model
-	911 645 301 04	Antenna Radio Installation parts Telescopic antenna with Key		1	
-	911 645 033 06	Antenna Chrome Rosette Black	-80	1	
-	911 645 033 04	Automatic antenna	81-	1	
-	477 035 513	Antenna rod for Automatic antenna Radio		1	
>>	911 645 111 14	Installation set for Radio Porsche		1	
>>	911 645 906 00	Installation set Door speaker 8 OHM/8 W Comprising:	-82	1	
-	911 645 403 00	Door speaker 8 OHM Wiring harnesses Door Wiring harness Door Right Wiring harness Door Left Wiring harness Connecting line Wiring harness Loudspeaker Radio		2	
				2	
				1	
				1	
				1	
				1	
-	999 651 152 02	Cable clamp		2	
-	999 651 152 01	Cable clamp		2	
-	911 645 217 00	Housing for Loudspeaker		2	
-	900 146 009 02	Oval-head screw AM 4 X 12		4	
-	900 025 002 02	Washer A 4		16	
-	900 025 002 03	Washer A 4		16	
-	900 027 002 02	Lock ring		4	
-	N 011 004 6	Hexagon nut		4	
-	N 011 004 G	Nut		4	
-	900 143 007 02	Oval-head sheetmetal screw B 4,2 X 13		8	
-	900 073 507 01	Oval-head sheetmetal screw B 4,2 X 13		8	
>>	911 645 405 02	Installation set Stereo rear loudspeaker Only together with Back wall lining for Loudspeaker And	-82	1	

Model: 911 78

Model life 1978>>1983

Pos	Part Number	Description	Remark	Qty	Model
-	911 645 403 01	Door speaker Comprising: Rear loudspeaker 8 OHM/ 5 W		2	
-	900 025 002 02	Washer A 4,3		8	
-	900 025 002 03	Washer A 4,3		8	
-	N 011 004 6	Hexagon nut M 4		8	
-	N 011 004 G	Nut M 4		8	
-	N 012 224 3	Spring washer A 4		8	
-	911 612 067 01	Wiring harness for Rear loudspeaker		1	
-	911 612 095 02	Wiring harness Rear loudspeaker Radio		1	
-	911 645 409 00	Door speaker		2	
-	911 645 435 00	Rear loudspeaker		2	
-	911 645 605 00	Fader		1	
-	928 645 413 00	Mid-range loudspeaker Side trim panel		2	
-	928 645 423 00	Loudspeaker grille		2	
-	900 143 132 07	Tapping screw B 3,9 X 16		8	

Model: 911 78

Model life 1978>>1983

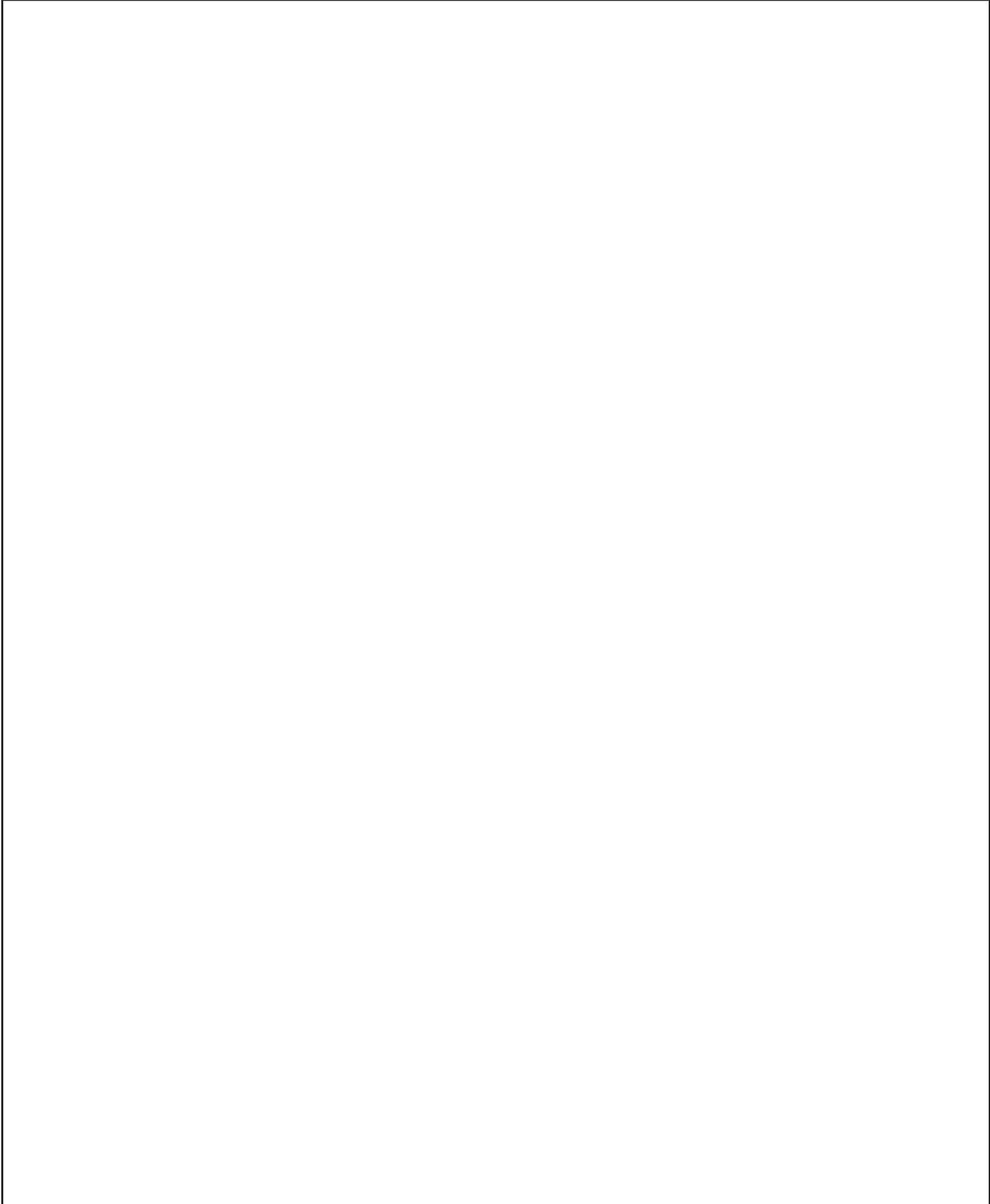

Model: 911 78

Model life 1978>>1983

Pos	Part Number	Description	Remark	Qty	Model
-	911 645 190 00	Radio Navigation system Installation parts		1	
-	911 645 191 00	Radio Navigation system with PORSCHE logo		1	
-	911 645 192 00	Radio Navigation system with TMC with PORSCHE logo		1	
-	911 645 192 X	Radio Navigation system with TMC without PORSCHE logo		1	
-	911 645 195 00	Cover for Radio Navigation system with PORSCHE logo		1	
-	911 645 197 00	Cover for Radio Navigation system without PORSCHE logo		1	
-	911 645 196 00	Adapter		1	
-	911 642 105 00	Adapter		1	
-	911 642 105 00	Antenna		1	
-	911 642 100 00	Antenna		1	
-	911 642 100 00	Software Update 1-2011		1	
-	911 642 100 01	Software Update 1-2013		1	
-	911 642 100 02	Software Update 1-2014		1	
-	911 642 107 00	Microphone		1	
-	911 645 199 00	Handheld transmitter		1	
-	911 645 190 01	Navigation system Knob Control part Navigation system		2	

Model: 911 78

Model life 1978>>1983

FARBNUMMER
 COLOUR NUMBER
 NUMERO DE COULEUR
 NUMERO COLORE
 NUMERO DE COLOR

80K|9 2
GUARDS RED
INDISCHROT
G1

FARB BENENNUNG
 COLOUR
 COULEUR
 COLORE
 COLOR

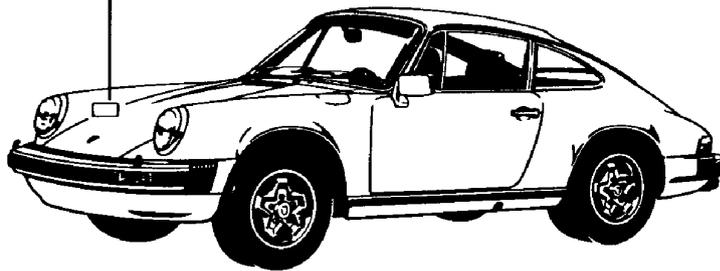

Model: 911 78

Model life 1978>>1983

Pos	Part Number	Description	Remark	Qty	Model
-	ALN 787 003 10	Lacquers Basic materials Polyester filler 1 KG		X	
-	ALN 787 003 20	Polyester filler 2 KG		X	
-	ALZ 018 000 02	Hardener for Polyester filler 30 GRAMM		X	
-	L 014 200	Spotting putty 1 KG		X	
-	ALN 788 007	Spray filler 1 L		X	
-	ALZ 840 000 02	Hardener for Spray filler 25 ML		X	
-	911 096 162 04	Primer R48 SUPER Comprising: Wash primer 2 KG Hardener 1 KG		X	
-	911 096 310 06	Thinner for Wash primer 1 L		X	
-	ALN 786 000 13	Acrylic primer filler 3 L		X	
-	ALZ 009 001 06	Hardener for Primer filler Long 500 ML		X	
-	ALZ 009 002 06	Hardener for Primer filler Short 500 ML		X	
-	ALV 855 000 15	Thinner for Primer filler 5 L		X	
-	ALN 790 000 13	Acrylic primer filler HIGH SOLID 3 L		X	
-	999 915 330 40	High build coating EPOXY F90 1 L		X	
-	999 901 010 40	Hardener for High build coating F 90 1 L		X	
-	999 901 008 40	Polyurethane prime coat 1 L		X	
-	999 901 009 40	Hardener for Polyurethane prime coat 1 L		X	
-	911 096 330 03	Thinner		X	

Model: 911 78 Model life 1978>>1983

Pos	Part Number	Description	Remark	Qty	Model
		for			
		Polyurethane prime coat			
-	911 096 271 05	1 L		X	
		Polyurethane plastic putty			
-	999 901 012 40	500 GR		X	
		Underbody protection			
		Underbody protection			
		White			
		1 L			
-	999 901 011 40	Underbody protection		X	
		Underbody protection			
		Grey			
		1 L			
-	L 016 006	Nitro-cellulose thinner		X	
		2,5 L			
-	000 043 001 00	Tin		X	
		SN 90 %, 300 G			
-	911 095 903 80	Synthetic resin prime coat		X	
		1 L			
	911 095 903 80 265	Oak green metallic			265
	911 095 903 80 275	Lind green			275
	911 095 903 80 30T	Light blue metallic			30T
	911 095 903 80 304	Minerva blue			304
	911 095 903 80 376	Petrol blue			376
	911 095 903 80 443	Brown copper			443
	911 095 903 80 463	Casablanca beige metallic			463
	911 095 903 80 464	Tobacco metallic			464
	911 095 903 80 708	Black-metallic			708
	911 095 903 80 936	Silver metallic			936
	911 095 903 80 20C	Moss green metallic			20C
	911 095 903 80 31G	Metallic blue shade			31G
	911 095 903 80 474	Rosewood			474
	911 095 903 80 655	Platinum-metallic			655
	911 095 903 80 895	Burgundy-metallic			895
	911 095 903 80 956	Zinc metallic			956
	911 095 903 80 961	Meteor metallic			961
	911 095 903 80 655	Platinum-metallic			655
	911 095 903 80 661	Slate grey metallic			661
	911 095 903 80 662	Smoked quartz			662
	911 095 903 80 810	Ruby red metallic			810
	911 095 903 80 811	Brick red			811
	911 095 903 80 20C	Moss green metallic			20C
-	911 096 320 00	Thinner		X	
		for			
		Synthetic resin lacquer			
-	911 095 902 60	Top-coat paint		X	
		1 L			
	911 095 902 60 027	Guards red			027
	911 095 902 60 106	Talbot yellow			106
	911 095 902 60 107	Orange			107
	911 095 902 60 260	Green			260
	911 095 902 60 273	Fern green			273
	911 095 902 60 274	Olive green			274
	911 095 902 60 305	Arrow blue			305
	911 095 902 60 408	Bitter chocolate			408
	911 095 902 60 451	Mocha black			451
	911 095 902 60 502	Cashmere beige			502
	911 095 902 60 700	Black			700
	911 095 902 60 908	Grand prix white			908
	911 095 902 60 601	Flieder/Lilac Grey Met.			601
	911 095 902 60 20A	Mint green			20A
	911 095 902 60 182	White			182
	911 095 902 60 523	Bamboo beige			523

Model: 911 78 Model life 1978>>1983

Pos	Part Number	Description	Remark	Qty	Model
	911 095 902 60 524	Caramel			524
	911 095 902 60 32Z	Glacier blue metallic			32Z
-	ALN 769 000 10	Clear lacquer 1 L		X	
-	ALV 855 000 15	Thinner for 2k - acryl lacquer 5L		X X	
-	911 095 932 20	Paint touch-up applicator		X	
	911 095 932 20 027	Guards red			027
	911 095 932 20 106	Talbot yellow			106
	911 095 932 20 107	Orange			107
	911 095 932 20 260	Green			260
	911 095 932 20 265	Oak green metallic			265
	911 095 932 20 273	Fern green			273
	911 095 932 20 274	Olive green			274
	911 095 932 20 304	Minerva blue			304
	911 095 932 20 305	Arrow blue			305
	911 095 932 20 408	Bitter chocolate			408
	911 095 932 20 451	Mocha black			451
	911 095 932 20 502	Cashmere beige			502
	911 095 932 20 700	Black			700
	911 095 932 20 908	Grand prix white			908
	911 095 932 20 601	Flieder/Lilac Grey Met.			601
	911 095 932 20 20A	Mint green			20A
	911 095 932 20 182	White			182
	911 095 932 20 523	Bamboo beige			523
	911 095 932 20 524	Caramel			524
	911 095 932 20 32Z	Glacier blue metallic			32Z
-	911 095 933 20	Paint touch-up applicator Set Comprising: Paint touch-up applicator Top-coat paint Paint touch-up applicator Clear lacquer		X	
	911 095 933 20 20C	Moss green metallic			20C
	911 095 933 20 275	Lind green			275
	911 095 933 20 376	Petrol blue			376
	911 095 933 20 443	Brown copper			443
	911 095 933 20 936	Silver metallic			936
	911 095 933 20 30T	Light blue metallic			30T
	911 095 933 20 463	Casablanca beige metallic			463
	911 095 933 20 464	Tobacco metallic			464
	911 095 933 20 708	Black-metallic			708
	911 095 933 20 31G	Metallic blue shade			31G
	911 095 933 20 474	Rosewood			474
	911 095 933 20 655	Platinum-metallic			655
	911 095 933 20 895	Burgundy-metallic			895
	911 095 933 20 956	Zinc metallic			956
	911 095 933 20 661	Slate grey metallic			661
	911 095 933 20 662	Smoked quartz			662
	911 095 933 20 810	Ruby red metallic			810
	911 095 933 20 811	Brick red			811
-	911 096 220 05	Hardener LESONAL 500 ML		X	
-	911 096 220 02	Hardener GLASURIT 500 ML		X	
-	911 096 220 12	Hardener for Clear lacquer		X	

Model: 911 78

Model life 1978>>1983

Pos	Part Number	Description	Remark	Qty	Model
-	911 096 300 17	500 ML Thinner for Black mat 1 KG		X	TURBO

Model: 911 78

Model life 1978>>1983

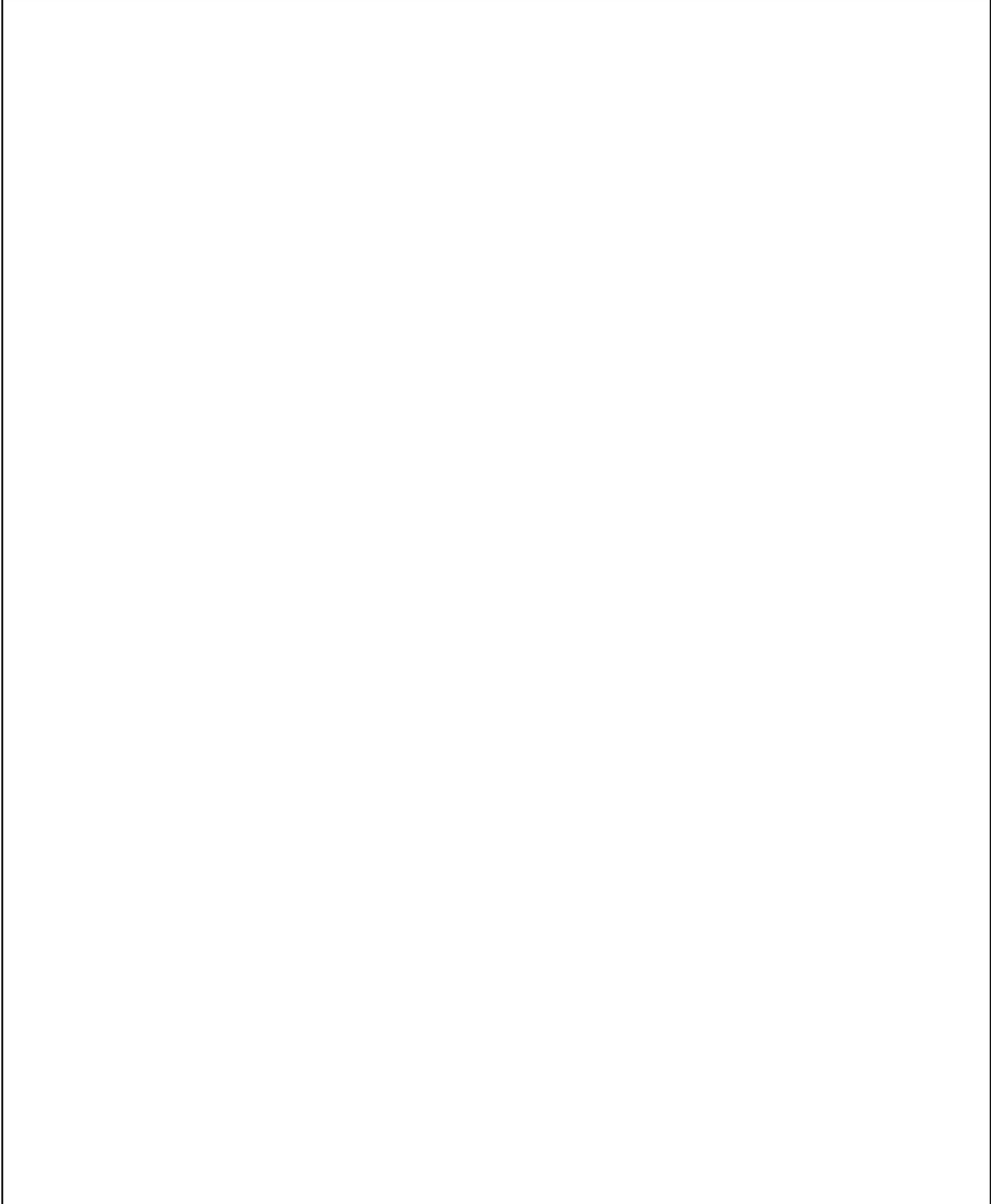

Model: 911 78

Model life 1978>>1983

Pos	Part Number	Description	Remark	Qty	Model
-	928 101 921 00	Securing liquid Sealing compound Preservative agent Securing liquid Loctite -270- 10 CCM High strength		X	
-	000 043 012 00	Loctite -221- 10 CCM Low strength		X	
-	000 043 306 48	Loctite -221- 10 CCM Low strength Sealing compound		X	
-	000 043 010 00	Loctite -574- 50 CCM		X	
-	000 043 011 00	Loctite -638- 10 CCM for Balance shaft		X	
-	000 043 013 00	Loctite Adhesive remover -80646- Spraying can		X	
-	AMV 176 000 05	Adhesive sealing compound 310 CCM Loctite for pasting Metal Glass Ceramics Thermoset plastic Adhesive set Comprising:		1	
-	000 043 051 00	Loctite Loctite -317- 50 CCM		X	
-	000 043 202 65	Loctite AKTIVATOR NF 736 180 CCM		X	
-	000 043 019 01	Sealing compound SILASTIK 730 RTV 90 CCM		X	
-	PCG 043 019 01	Sealing compound SILASTIK 730 RTV 90 CCM		X	
-	000 043 004 00	Mounting paste Optimoly ht 1 90-gramme tube		X	
-	000 043 020 00	Optimoly Mounting paste OPTIMOLY - TA 1 100-gramme tube		X	
-	000 043 110 01	Silver Grease OPTITEMP PU35 1 tube		X	

Model: 911 78

Model life 1978>>1983

Pos	Part Number	Description	Remark	Qty	Model
-	000 043 204 21	100 G Grease for lock cylinder Spraying can		X	
-	G 052 778 A2	Grease for lock cylinder Spraying can Preservative agent		X	
-	999 571 062 00	Care kit Comprising: Suitcase		1	
-	999 901 013 40	Liquid preservative		1	
-	999 901 014 41	Car shampoo		1	
-	999 901 015 40	Polisher		1	
-	999 901 016 40	Tar remover		1	
-	999 901 017 40	Dashboard cleaner		1	
-	999 901 018 40	Paint polish		1	
-	999 901 019 41	Insect remover		1	
-	999 901 020 40	Spot remover		1	
-	999 901 021 40	Polishing cotton		1	
-	999 901 022 40	Polishing cloth		1	
-	000 044 000 02	Leather care 250 ML		X	
-	999 901 017 41	Window cleaner Summer 250 ML		X	
-	999 901 017 42	Window cleaner Summer 250 ML		X	
-	000 044 000 87	Window cleaner Summer 250 ML		X	
-	999 901 033 40	Window cleaner Winter 1000 ML		X	
-	999 901 036 40	Car shampoo Refilling bottle 1000 ML		X	
-	999 917 803 00	Window cleaner Spray bottle 250 ML		X	
-	928 628 931 00	Silicone remover 1000 ML		X	
-	000 044 000 93	Silicone remover 1000 ML		X	
-	999 901 030 40	Rim cleaner Spray bottle 500 ML		X	
-	999 901 031 40	Rim cleaner Refilling bottle 1000 ML		X	

Model: 911 78

Model life 1978>>1983

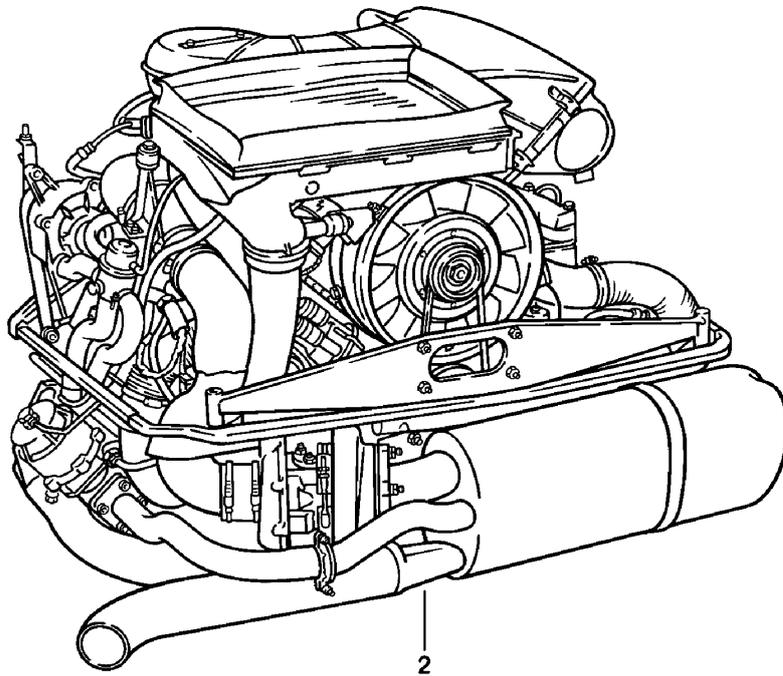
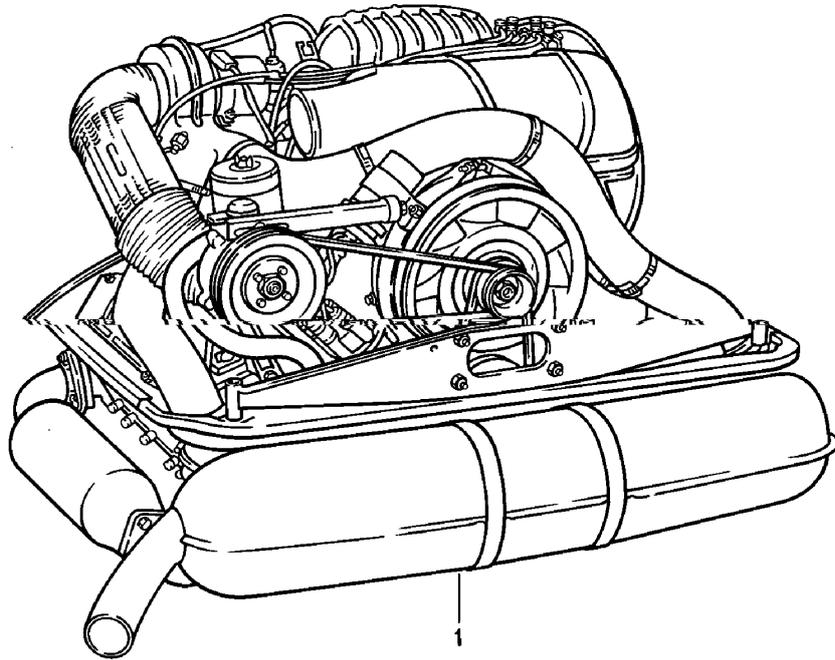

Model: 911 78

Model life 1978>>1983

Pos	Part Number	Description	Remark	Qty	Model
1	930 100 203 00	Replacement engine Engine		1	930.03 COUPE/TARGA
1	930 100 209 00	Engine		1	930.09 COUPE/TARGA
1	930 100 210 00	Engine		1	930.10 COUPE/TARGA
1	930 100 210 01	Engine		1	930.10 CABRIO
1	930 100 213 00	Engine		1	930.13 COUPE/TARGA
1	930 100 219 00	Engine		1	930.19 COUPE/TARGA
2	930 100 260 00	Engine		1	930.60
2	930 100 266 04	Engine		1	930.66

Model: 911 78

Model life 1978>>1983

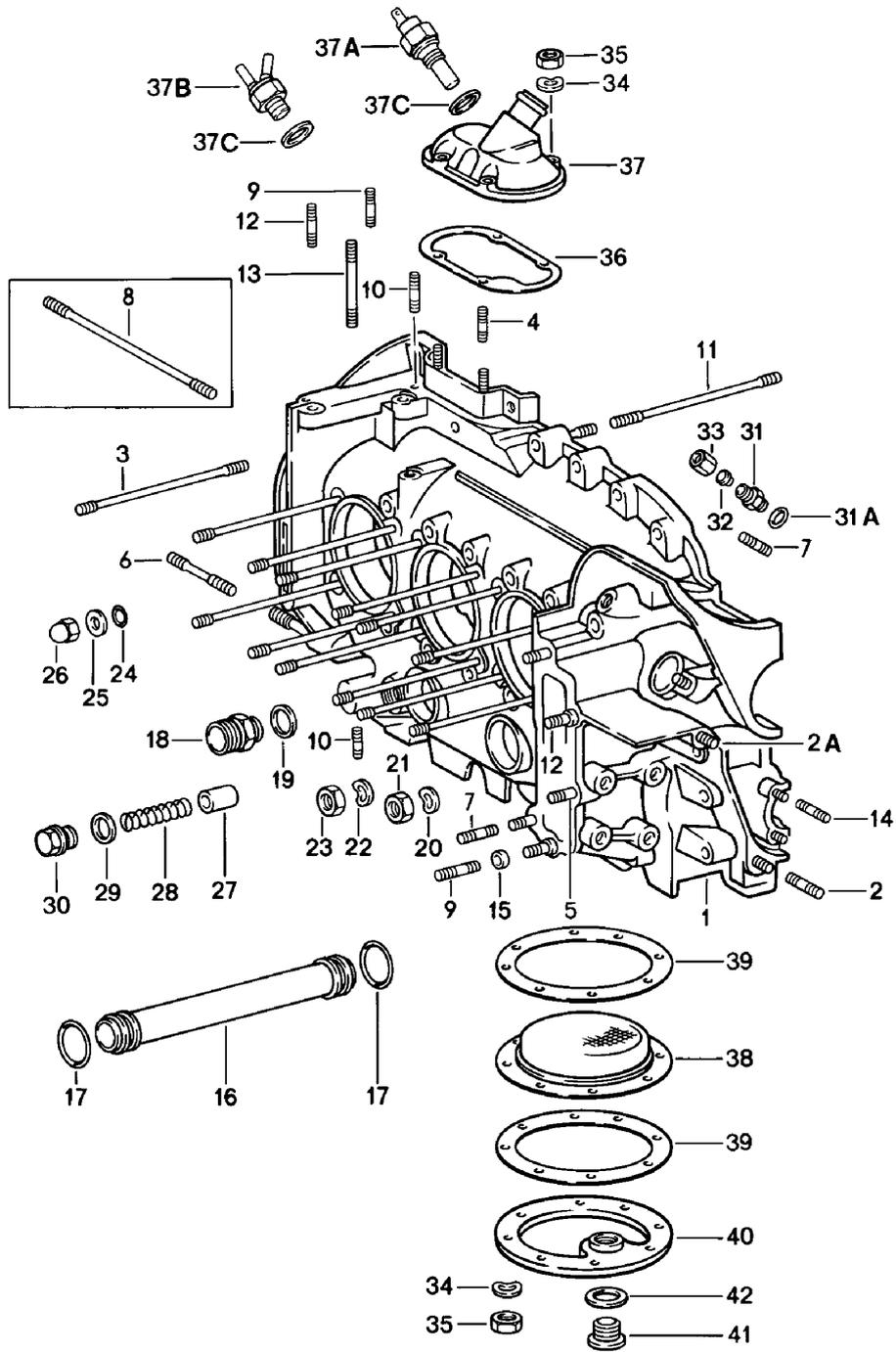

Model: 911 78 Model life 1978>>1983

Pos	Part Number	Description	Remark	Qty	Model
1	930 101 915 00	Crankcase Left Crankcase with studs M >> 63D 4069 M >> 64D 3716 M >> 63D 8154 M >> 67D 0711		1	SC
1	930 101 917 00	Crankcase with studs M 63D 4070 >> M 64D 3717 >> M 63D 8155 >> M 67D 0712 >>		1	SC
-	911 101 183 00	Stopper 16 x 11 M 63D 4070 >> M 64D 3717 >> M 63D 8155 >> M 67D 0712 >>		X	SC
1	930 101 916 00	Crankcase with studs M >> 63D 4069 M >> 64D 3716 M >> 63D 8154 M >> 67D 0711		1	TURBO
1	930 101 918 00	Crankcase with studs M 63D 4070 >> M 64D 3717 >> M 63D 8155 >> M 67D 0712 >>		1	TURBO
2	999 062 090 02	Stud M 10 X 40 M >> 63D 4069 M >> 64D 3716 M >> 63D 8154 M >> 67D 0711		1	SC
2	999 062 207 02	Stud M 10 X 45 M >> 63D 4069 M >> 64D 3716 M >> 63D 8154 M >> 67D 0711		1	TURBO
(2)	999 062 039 02	Stud M 10 X 50 M >> 63D 4069 M >> 64D 3716 M >> 63D 8154 M >> 67D 0711		1	SC
(2)	999 062 183 02	Stud M 10 X 50 M >> 63D 4069 M >> 64D 3716 M >> 63D 8154 M >> 67D 0711		1	SC
(2)	999 062 060 02	Stud M 10 X 80 M >> 63D 4069 M >> 64D 3716 M >> 63D 8154 M >> 67D 0711		1	TURBO
3	911 101 172 00	Stud		12	SC

Model: 911 78 Model life 1978>>1983

Pos	Part Number	Description	Remark	Qty	Model
3	930 101 170 00	Upper Stud (DILAVAR)		12	SC
3	993 101 170 51	Lower Stud		12	SC
3	930 101 170 00	Stud (DILAVAR)		24	TURBO
3	993 101 170 51	Stud		24	TURBO
4	999 062 085 02	Stud		4	
5	999 062 006 02	M 6 X 20 Stud		2	
6	999 061 034 02	M 8 X 20 Stud		2	SC
6	999 062 192 02	M 10 X 69 Stud		1	TURBO
(6)	999 062 099 02	M 10 X 102 Stud		1	TURBO
(6)	900 060 096 01	M 10 X 105 Stud		1	TURBO
7	999 062 007 02	M 10 X 105 Stud		5	
7	900 060 106 01	M 8 X 20 Stud		5	
8	999 062 099 02	M 8 X 20 Stud	SPM	2	SC
8	900 060 096 01	M 10 X 105 Stud	SPM	2	SC
9	999 062 009 02	M 10 X 105 Stud		3	
9	900 060 105 01	M 8 X 28 Stud		3	
10	999 062 055 02	M 8 X 28 Stud		4	
11	930 101 174 01	M 6 X 12 Stud		2	
12	999 062 008 02	M 8 X 25 Stud		3	
13	999 062 147 02	M 8 X 62 Stud		1	
14	999 062 002 02	M 6 X 15 Stud M >> 63D 4069 M >> 64D 3716 M >> 63D 8154 M >> 67D 0711		3	
15	901 101 145 00	Dowel sleeve		2	
16	901 107 351 01	Oil tube		4	
16	930 107 040 00	Oil tube		X	
		Divided Set			
		Comprising:			
		Oil tube		1	
		Oil tube		1	
16	930 107 040 01	Set		X	
		Divided Set			
		Comprising:			
		Oil tube		1	
		Oil tube		1	
-	900 041 013 01	Circlip		1	
-	999 707 113 40	Round seal		2	
-	999 707 113 41	O-ring		2	
-	999 707 112 40	Round seal		2	

Model: 911 78 Model life 1978>>1983

Pos	Part Number	Description	Remark	Qty	Model
-	999 707 112 4A	Round seal		2	
17	999 707 112 40	Round seal		8	
17	999 707 112 4A	Round seal		8	
18	999 136 008 09	Connection piece		1	
18	999 136 008 01	Connection piece		1	
19	900 123 011 30	Sealing ring A 22 X 27		1	
-	911 101 011 01	Spray jet		3	SC
-	930 101 015 00	Spray jet		3	TURBO
20	900 031 014 30	Washer 8,4		24	
21	900 910 022 02	Lock nut M 8		24	
22	N 012 242 3	Spring washer B 10 X 18		1	
23	900 076 052 02	Hexagon nut M 10 X 1		1	
24	999 701 006 40	O-ring		12	
25	901 101 161 01	Washer		12	
(25)	901 101 161 02	Washer		12	
26	930 101 172 01	Cap nut M10 X 1		13	
27	911 107 512 00	Piston		1	
28	901 107 531 00	Compression spring		1	
29	900 123 106 30	Sealing ring A 18 X 24		1	
30	999 064 026 02	Screw plug		1	
30	999 064 026 01	Screw plug		1	
31	901 107 375 00	Screw socket		1	
31A	900 123 101 30	Sealing ring A 12 X 18		1	
32	N 020 825 1	Cutting ring LL 8		1	
32		Cutting ring LL 8		1	
33	900 104 003 02	Union nut A II 8		1	
33	900 104 003 03	Union nut A II 8		1	
34	N 012 226 5	Spring washer B 6 M >> 63D 4069 M >> 64D 3716 M >> 63D 8154 M >> 67D 0711		12	
35	900 076 010 02	Nut M 6 M >> 63D 4069 M >> 64D 3716 M >> 63D 8154 M >> 67D 0711		12	
35	900 076 010 0B	Nut M 6 M >> 63D 4069 M >> 64D 3716 M >> 63D 8154 M >> 67D 0711		12	
36	930 107 791 00	Gasket		1	
37	901 107 073 02	Lid		1	SC
37		Lid	-82	1	TURBO
37	930 107 073 00	Lid	83-	1	TURBO
37B	930 110 401 01	Thermo valve	83-	1	TURBO
37C	900 123 007 30	Sealing ring	83-	1	TURBO

Model: 911 78 Model life 1978>>1983

Pos	Part Number	Description	Remark	Qty	Model
38	930 107 314 00	A 14 X 18 Oil strainer M >> 63D 4069 M >> 64D 3716 M >> 63D 8154 M >> 67D 0711		1	SC
(38)	930 107 313 01	Oil strainer M >> 63D 4069 M >> 64D 3716 M >> 63D 8154 M >> 67D 0711		1	TURBO
39	930 101 391 01	Gasket M >> 63D 4069 M >> 64D 3716 M >> 63D 8154 M >> 67D 0711		2	
(40)	930 101 902 00	Lid Technical information Gr.1 nr.1/85		1	
41	911 107 176 03	Screw plug M >> 63D 4069 M >> 64D 3716 M >> 63D 8154 M >> 67D 0711		1	
41		Screw plug M >> 63D 4069 M >> 64D 3716 M >> 63D 8154 M >> 67D 0711		1	
41	944 107 197 01	Screw plug M 63D 4070 >> M 64D 3717 >> M 63D 8155 >> M 67D 0712 >>		1	
41		Screw plug		1	
42	900 123 011 20	Sealing ring A 22 X 27 M >> 63D 4069 M >> 64D 3716 M >> 63D 8154 M >> 67D 0711		1	
42	900 123 118 30	Sealing ring A 22 X 27 M 63D 4070 >> M 64D 3717 >> M 63D 8155 >> M 67D 0712 >>		1	

Model: 911 78

Model life 1978>>1983

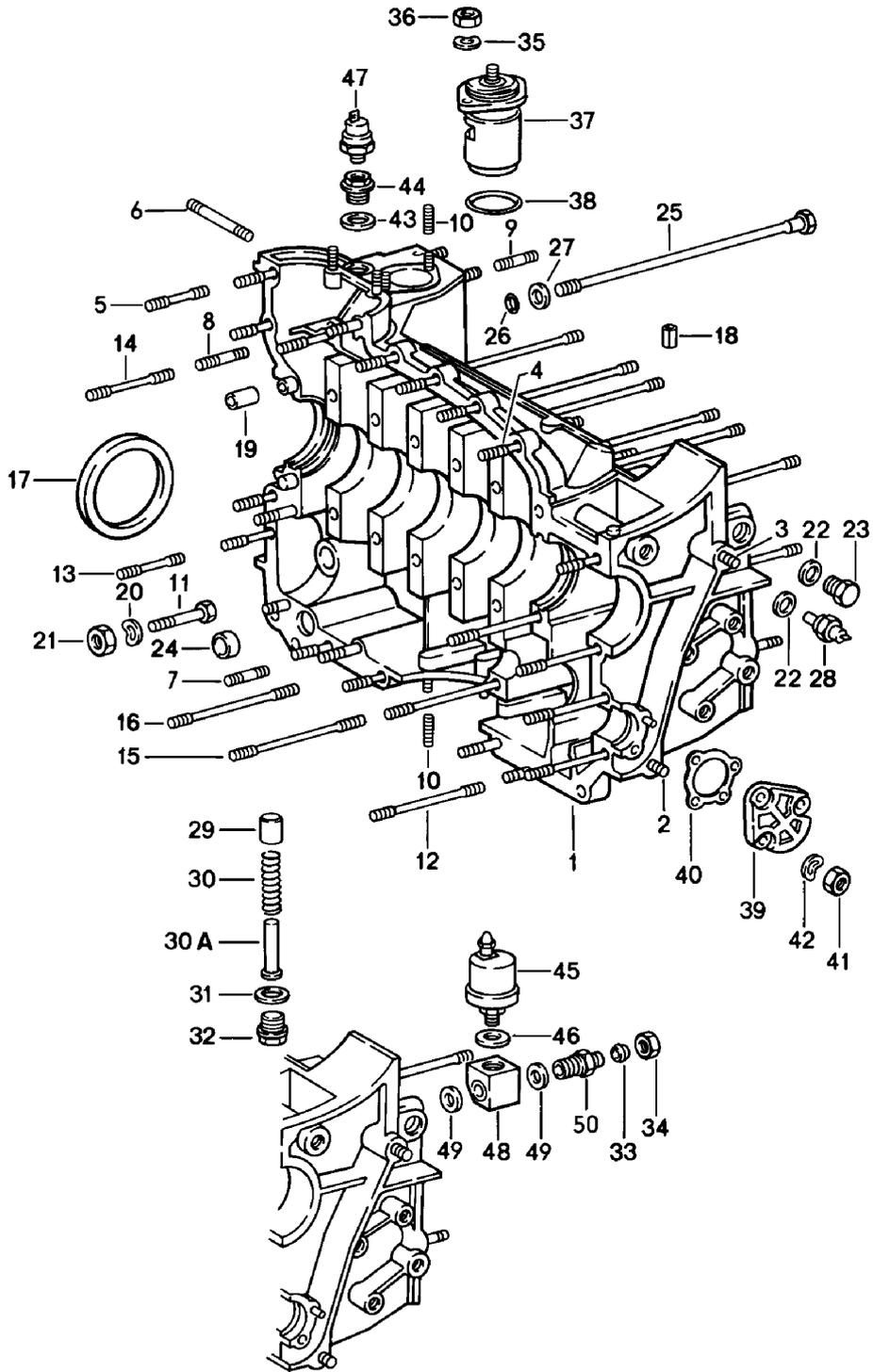

Model: 911 78 Model life 1978>>1983

Pos	Part Number	Description	Remark	Qty	Model
1	930 101 915 00	Crankcase Right Crankcase with studs M >> 63D 4069 M >> 64D 3716 M >> 63D 8154 M >> 67D 0711		1	SC
1	930 101 917 00	Crankcase with studs M 63D 4070 >> M 64D 3717 >> M 63D 8155 >> M 67D 0712 >>		1	SC
-	911 101 183 00	Stopper 16 x 11 M 63D 4070 >> M 64D 3717 >> M 63D 8155 >> M 67D 0712 >>		X	SC
1	930 101 916 00	Crankcase with studs M >> 63D 4069 M >> 64D 3716 M >> 63D 8154 M >> 67D 0711		1	TURBO
1	930 101 918 00	Crankcase with studs M 63D 4070 >> M 64D 3717 >> M 63D 8155 >> M 67D 0712 >>		1	TURBO
2	999 062 090 02	Stud M 10 X 40 M >> 63D 4069 M >> 64D 3716 M >> 63D 8154 M >> 67D 0711		1	SC
2	999 062 207 02	Stud M 10 X 45 M >> 63D 4069 M >> 64D 3716 M >> 63D 8154 M >> 67D 0711		1	TURBO
3	999 061 056 02	Stud M 10 X 45 M >> 63D 4069 M >> 64D 3716 M >> 63D 8154 M >> 67D 0711		1	
4	999 062 010 02	Stud M 8 X 35		1	
5	999 062 115 02	Stud M 8 X 32		13	
6	999 062 192 02	Stud M 10 X 102		1	SC
(6)	999 062 191 02	Stud M 10 X 145	SPM	1	SC
(6)	999 062 225 02	Stud BM 10 X 140		1	TURBO
(6)	900 060 095 01	Stud BM 10 X 140		1	TURBO
7	999 062 006 02	Stud		3	

Model: 911 78 Model life 1978>>1983

Pos	Part Number	Description	Remark	Qty	Model
8	999 062 009 02	M 8 X 20 Stud		1	
8	900 060 105 01	M 8 X 28 Stud		1	
9	999 062 073 02	M 8 X 28 Stud		4	
10	999 062 055 02	M 8 X 15 Stud		7	
		M 6 X 12			
		M >> 63D 4069			
		M >> 64D 3716			
		M >> 63D 8154			
		M >> 67D 0711			
11	900 074 134 02	Hexagon-head bolt M 8 X 45		1	
12	900 060 101 01	Stud M 8 X 78		3	
13	999 062 075 02	Stud M 8 X 48		2	
14	999 062 138 02	Stud M 8 X 52		1	
14	900 060 102 01	Stud M 8 X 52		1	
15	999 062 051 02	Stud M 8 X 108		1	
16	930 101 175 00	Stud		1	
17	999 113 264 40	Radial sealing ring		1	
17	999 113 461 40	Radial sealing ring		1	
17	999 113 426 40	Radial sealing ring		1	
17	999 113 426 41	Radial sealing ring		1	
18	900 095 025 01	Roll pin 8 X 16		1	
19	901 101 195 00	Dowel sleeve		2	
20	900 031 014 30	Washer 8,4		1	
21	900 910 022 02	Lock nut M 8		1	
22	900 123 007 30	Sealing ring 14 X 18		1	
23	900 124 002 02	Screw plug AM 14 X 1,5	SPM	1	SC
24	999 704 172 50	Sealing ring		1	
25	930 101 173 02	Screw		11	
26	999 701 006 40	O-ring		12	
27	901 101 161 01	Washer		12	
(27)	901 101 161 02	Washer		12	
-	911 101 011 01	Spray jet		3	SC
-	930 101 015 00	Spray jet		3	TURBO SC
28	901 641 632 00	Remote temperature sensor	SPM	1	
28	911 606 112 00	Remote temperature sensor		1	
29	911 107 512 00	Piston		1	
30	930 107 531 01	Compression spring		1	
30A	930 107 533 00	Guide sleeve		1	
30A	930 107 533 01	Guide sleeve		1	
31	900 123 106 30	Sealing ring A 18 X 24		1	
32	999 064 026 02	Screw plug	-80	1	
32		Screw plug		1	
32	999 064 026 01	Screw plug		1	
33	N 020 825 1	Cutting ring LL 8		1	
34	900 104 003 02	Union nut A II 8		1	

Model: 911 78 Model life 1978>>1983

Pos	Part Number	Description	Remark	Qty	Model
34	900 104 003 03	Union nut A II 8		1	
35	N 012 226 5	Spring washer B 6		2	
36	900 076 010 02	Nut M 6		2	
36	900 076 010 0B	Nut M 6		2	
37	930 107 765 00	Oil thermostat		1	
38	999 701 053 40	O-ring 39,2 X 3		1	
39	911 105 162 00	Cover M >> 63D 4069 M >> 64D 3716 M >> 63D 8154 M >> 67D 0711		1	
(39)	930 105 165 00	Cover M 63D 4070 >> M 64D 3717 >> M 63D 8155 >> M 67D 0712 >>		1	
40	930 105 198 01	Gasket M >> 63D 4069 M >> 64D 3716 M >> 63D 8154 M >> 67D 0711		1	
(40)	999 701 658 40	Round seal 33,3 X 2,4 M 63D 4070 >> M 64D 3717 >> M 63D 8155 >> M 67D 0712 >>		1	
41	900 910 012 02	Lock nut M 6 M >> 63D 4069 M >> 64D 3716 M >> 63D 8154 M >> 67D 0711		3	
41	900 910 047 09	Lock nut M 6 M >> 63D 4069 M >> 64D 3716 M >> 63D 8154 M >> 67D 0711		3	
41	900 075 057 02	Hexagon-head bolt M 6 X 16 M 63D 4070 >> M 64D 3717 >> M 63D 8155 >> M 67D 0712 >>		2	
41	900 075 057 03	Hexagon-head bolt M 6 X 16 M 63D 4070 >> M 64D 3717 >> M 63D 8155 >> M 67D 0712 >>		2	
41	900 075 057 02	Hexagon-head bolt M 6 X 16 M 63D 4070 >> M 64D 3717 >> M 63D 8155 >> M 67D 0712 >>		2	
42	900 031 011 30	Washer		3	

Model: 911 78

Model life 1978>>1983

Pos	Part Number	Description	Remark	Qty	Model
43	900 123 140 30	6,4 Sealing ring A 18 X 22		1	
44	901 101 175 01	Reducing socket		1	SC
(44)	930 107 705 00	Reducing socket		1	TURBO
45	911 606 111 01	Pressure transmitter		1	
45	911 606 111 03	Pressure transmitter		1	
46	900 123 009 20	Sealing ring		1	
47	911 606 230 00	Oil pressure switch	-79	1	
47		Oil pressure switch	80-	1	
48	911 107 704 00	Connection piece		1	
49	900 123 101 30	Sealing ring A 12 X 18		2	
50	911 107 709 01	Screw socket		1	
-	900 108 022 00	Ball \$ 9 MM		1	TURBO

Model: 911 78

Model life 1978>>1983

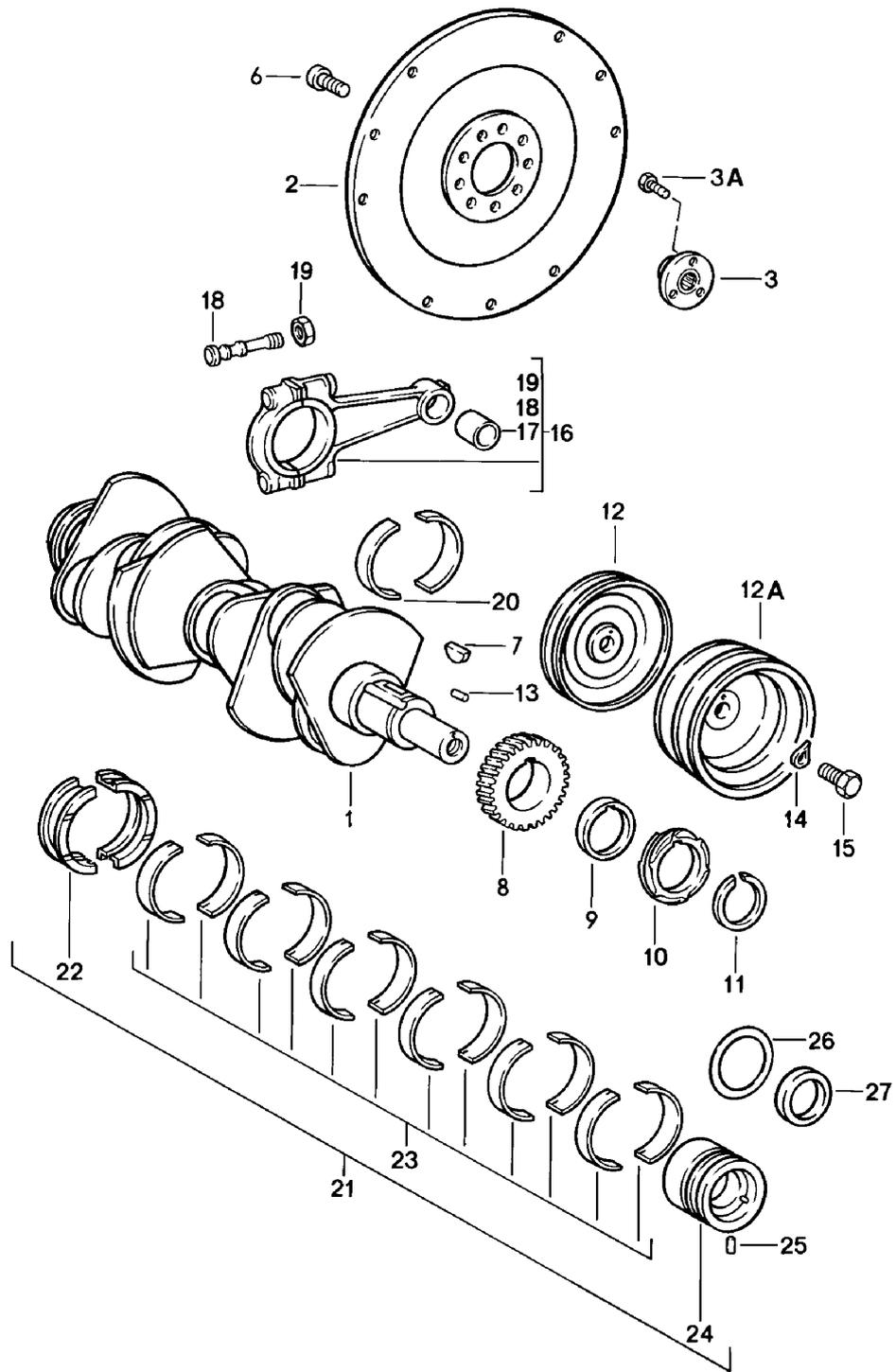

Model: 911 78 Model life 1978>>1983

Pos	Part Number	Description	Remark	Qty	Model
1	930 102 015 01	Crankshaft	-79	1	SC
1	930 102 015 05	Crankshaft	80-	1	SC
1	930 102 015 08	Crankshaft	80-	1	SC
1	930 102 014 00	Crankshaft	-79	1	TURBO
1	930 102 014 04	Crankshaft	80-	1	TURBO
1	930 102 014 10	Crankshaft	80-	1	TURBO
1	930 102 014 11	Crankshaft	80-	1	TURBO
		M 639 4606 >>			SC
		M 629 2281 >>			SC
		M 619 0294 >>			SC
		M 659 1576 >>			SC
		M 679 0896 >>			TURBO
		M 689 1232 >>			TURBO
		M 689 0505 >>			TURBO
2	930 102 204 03	Flywheel		1	SC
2	930 102 204 00	Flywheel	-79	1	SC
2	930 102 204 03	Flywheel		1	SC
2	930 102 215 00	Flywheel	80-	1	SC
2	930 102 202 01	Flywheel	-79	1	TURBO
2	930 102 213 00	Flywheel	80-	1	TURBO
3	901 102 025 01	Bush	-79	1	SC
3	930 102 025 00	Bush	-79	1	TURBO
3A	900 067 008 03	Pan-head screw		3	
3A	900 067 008 02	Pan-head screw	80-	3	
		M 6 X 12			
3A	900 067 008 03	Pan-head screw	80-	3	
		M 6 X 12			
6	930 102 206 00	Pan-head screw		9	
7	901 102 147 00	Woodruff key		1	
8	901 102 111 00	Timing gear		1	
		(KENNZAHL) 0			
(8)	901 102 111 10	Timing gear		1	
		(KENNZAHL) 1			
(8)	901 102 111 20	Timing gear		1	
		(KENNZAHL) 1			
9	901 102 145 00	Intermediate ring		1	
10	930 102 115 01	Drive wheel		1	
10	930 102 115 02	Drive wheel		1	
11	901 102 148 00	Circlip		1	
		(KENNZAHL 0)			
11	901 102 148 01	Circlip		1	
		(KENNZAHL 1)			
11	901 102 148 02	Circlip		1	
		(KENNZAHL 2)			
11	901 102 148 03	Circlip		1	
		(KENNZAHL 3)			
12	930 102 028 01	Pulley	-78	1	SC
12	930 102 028 09	Pulley	-78	1	SC
12	930 102 028 04	Pulley	79-80	1	SC
12		Pulley	79-80	1	SC
		M 639 9202 >>			
		M 639 3869 >>			
12	930 102 028 08	Pulley	81-	1	SC
12		Pulley	81-	1	SC
12		Pulley	81-	1	SC
12	930 102 126 02	Pulley		1	TURBO
12A	930 102 023 01	Pulley	78	1	SC
					M559
					930.03/13
12A	930 102 023 03	Pulley	79-80	1	SC
					M559
					930.03/09/13

Model: 911 78 Model life 1978>>1983

Pos	Part Number	Description	Remark	Qty	Model
12A	930 102 023 05	Pulley	81-	1	930.19 SC
12A	930 102 017 04	Pulley		1	M559 930.10 TURBO M559
13	N 101 090 01	Straight pin 5M 6 X 12		1	
13	N 101 090 0A	Straight pin 5M 6 X 12		1	
13	N 101 090 01	Straight pin 5M 6 X 12		1	
13	N 101 090 0A	Straight pin 5M 6 X 12		1	
14	900 028 014 01	Lock ring B 12	-80	1	
14	900 028 014 02	Washer B 12		1	
14	900 028 014 03	Washer B 12		1	
15	999 093 005 02	Hexagon-head bolt M12 X 1,5 X 22		1	
16	930 103 015 51	Connecting rod Weight group: 1= 633 - 642 G		6	SC
16	930 103 015 52	Connecting rod Weight group: 2= 642 - 651 G		6	
16	930 103 015 53	Connecting rod Weight group: 3= 651 - 660 G		6	
16	930 103 015 54	Connecting rod Weight group: 4= 660 - 669 G		6	
16	930 103 015 55	Connecting rod Weight group: 5= 669 - 678 G		6	
16	930 103 015 56	Connecting rod Weight group: 6= 678 - 687 G		6	
16	930 103 015 57	Connecting rod Weight group: 7= 687 - 696 G		6	
16	930 103 015 58	Connecting rod Weight group: 8= 696 - 705 G		6	
16	930 103 015 59	Connecting rod Weight group: 9= 705 - 714 G		6	
-	930 103 974 00	Connecting rod Connecting rods Comprising: 6		1	SC
(16)	930 103 020 73	Connecting rod Connecting rod Weight group: 3 = 615 - 624 G		6	TURBO
(16)	930 103 020 74	Connecting rod Weight group: 4 = 624 - 633 G		6	
(16)	930 103 020 75	Connecting rod		6	

Model: 911 78 Model life 1978>>1983

Pos	Part Number	Description	Remark	Qty	Model
(16)	930 103 020 76	Weight group: 5 = 633 - 642 G Connecting rod		6	
(16)	930 103 020 77	Weight group: 6 = 642 - 651 G Connecting rod		6	
(16)	930 103 020 78	Weight group: 7 = 651 - 660 G Connecting rod		6	
(16)	930 103 020 79	Weight group: 8 = 660 - 669 G Connecting rod		6	
(16)	930 103 020 80	Weight group: 9 = 669 - 678 G Connecting rod		6	
(16)	930 103 020 81	Weight group: 10 = 678 - 687 G Connecting rod		6	
-	930 103 975 00	Weight group: 11 = 687 - 696 G Connecting rod 1 set Comprising: 6 Connecting rods		1	TURBO
17	901 103 131 01	Connecting rod bush		6	SC
17	930 103 134 01	Connecting rod bush		6	TURBO
18	914 103 171 00	Connecting rod bolt		12	SC
18	914 103 171 01	Connecting rod bolt		12	SC
18	964 103 176 00	Connecting rod bolt		12	TURBO
19	901 103 173 00	Connecting rod nut		12	SC
19	901 103 173 02	Connecting rod nut		12	SC
19	930 103 174 00	Connecting rod nut		12	TURBO
20	930 103 148 00	Connecting-rod bearing		12	SC
20	930 103 148 82	Connecting-rod bearing		12	SC
20	930 103 148 50	Connecting-rod bearing Oversize 0,25 MM		12	SC
20	930 103 148 83	Connecting-rod bearing Oversize 0,25 MM		12	SC
20	930 103 148 60	Connecting-rod bearing Oversize 0,50 MM		12	SC
20	930 103 148 70	Connecting-rod bearing Oversize 0,75 MM		12	SC
20	930 103 148 80	Connecting-rod bearing Oversize 1,00 MM		12	SC
20	930 103 147 15	Connecting-rod bearing Set		6	TURBO
20	930 103 147 50	Connecting-rod bearing Oversize 0,25 MM		12	TURBO
20	930 103 147 81	Connecting-rod bearing Oversize 0,25 MM		12	TURBO
20		Connecting-rod bearing Oversize 0,25 MM		12	
20	930 103 147 60	Connecting-rod bearing		12	TURBO

Model: 911 78 Model life 1978>>1983

Pos	Part Number	Description	Remark	Qty	Model
20	930 103 147 70	Oversize 0,50 MM Connecting-rod bearing		12	TURBO
20	930 103 147 80	Oversize 0,75 MM Connecting-rod bearing		12	TURBO
		Oversize 1,00 MM		12	TURBO
21	930 101 901 00	Set of crankshaft bearings		1	
		Comprising:			
22	930 101 131 15	Bearing shell		1	
		Set			
		I			
23	930 101 132 15	Bearing shell		12	
		II-VII			
24	964 101 138 01	Bearing sleeve		1	
		VIII			
21	930 101 901 51	Set of crankshaft bearings		1	
		Oversize 0.25 mm			
		Inner			
		Comprising:			
22	930 101 131 51	Bearing shell		2	
		I			
23	930 101 132 51	Bearing shell		12	
		II-VII			
23	930 101 132 92	Bearing shell		12	
		II-VII			
23		Bearing shell		12	
		Bearing shell			
		II-VII			
24	964 101 138 54	Bearing sleeve		1	
		VIII			
21	930 101 901 56	Set of crankshaft bearings		1	
		Oversize 0.50 mm			
		Inner			
		Comprising:			
22	930 101 131 56	Bearing shell		2	
		I			
23	930 101 132 56	Bearing shell		12	
		II-VII			
24	964 101 138 55	Bearing sleeve		1	
		VIII			
21	930 101 901 66	Set of crankshaft bearings		1	
		Oversize			
		0,75 MM			
		Inner			
		Comprising:			
22	930 101 131 66	Bearing shell		2	
		I			
23	930 101 132 66	Bearing shell		12	
		II-VII			
24	930 101 138 68	Bearing sleeve		1	
		VIII			
21	930 101 901 70	Set of crankshaft bearings		1	
		Oversize			
		1,00 MM			
		Inner			
		Comprising:			
22	930 101 131 70	Bearing shell		2	
		I			
23	930 101 132 70	Bearing shell		12	
		II-VII			
24	930 101 138 69	Bearing sleeve		1	

Model: 911 78 Model life 1978>>1983

Pos	Part Number	Description	Remark	Qty	Model
21	930 101 901 61	VIII Set of crankshaft bearings Oversize 0.25 mm Outer		1	
22	930 101 131 61	Comprising: Bearing shell I		2	
23	930 101 132 61	Bearing shell II-VII		12	
24	964 101 138 65	Bearing sleeve VIII		1	
21	930 101 901 71	Set of crankshaft bearings Oversize 0.25 mm Inner		1	
22	930 101 131 71	Oversize 0.25 mm Outer Comprising: Bearing shell I		2	
23	930 101 132 71	Bearing shell II-VII		12	
23	930 101 132 72	Bearing shell II-VII		12	
23		Bearing shell Bearing shell II-VII		12	
24	964 101 138 66	Bearing sleeve VIII		1	
21	930 101 901 76	Set of crankshaft bearings Oversize 0.50 mm Inner		1	
22	930 101 131 76	Oversize 0.25 mm Outer Comprising: Bearing shell I		2	
23	930 101 132 76	Bearing shell II-VII		12	
24	964 101 138 67	Bearing sleeve VIII		1	
21	930 101 901 86	Set of crankshaft bearings Oversize 0,75 MM Inner		1	
22	930 101 131 86	Oversize 0.25 mm Outer Comprising: Bearing shell I		2	
23	930 101 132 86	Bearing shell II-VII		12	
24	930 101 138 88	Bearing sleeve VIII		1	
21	930 101 901 90	Set of crankshaft bearings Oversize 1,00 MM Inner		1	
22	930 101 131 90	Oversize 0.25 mm Outer Comprising: Bearing shell I		2	
23	930 101 132 90	Bearing shell		12	

Model: 911 78

Model life 1978>>1983

Pos	Part Number	Description	Remark	Qty	Model
24	930 101 138 89	II-VII Bearing sleeve		1	
25	900 012 061 00	VIII Straight pin		1	
26	999 707 285 40	5 H 8 X 10 O-ring		1	
27	999 113 290 41	51 X 4,5 Radial sealing ring	-80	1	
27	999 113 290 40	30 X 50 X 10 Radial sealing ring		1	
		30 X 50 X 10			

Model: 911 78

Model life 1978>>1983

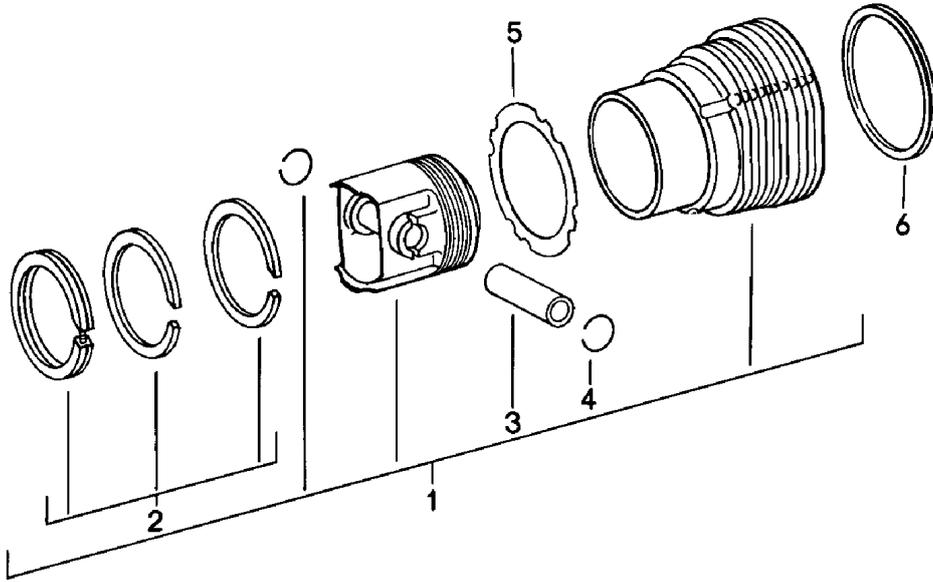

Model: 911 78 Model life 1978>>1983

Pos	Part Number	Description	Remark	Qty	Model
		Cylinder with piston See technical information GR.1 NR. 30 - mahle - Group 5			
1	930 103 962 03	Cylinder with piston Identification -- / - 660-668 G	-80	6	SC
1	930 103 983 05	Cylinder with piston Identification -- / - 668-676 G	81-	6	SC
1	930 103 962 04	Cylinder with piston Identification + / ++ 668-676 G	-80	6	SC
1	930 103 983 04	Cylinder with piston Identification + / ++ 676-684 G	81-	6	SC
1	PCG 503 989 0	Cylinder with piston Complete Fa. Mahle Only by sets		6	TURBO
(1)	930 103 969 03	Cylinder with piston Identification -- / - 616-624 G		6	TURBO
(1)	930 103 969 04	Cylinder with piston Identification + / ++ 624-632 G Supplier - mahle - Group 6		6	TURBO
1	930 103 962 05	Cylinder with piston Identification -- / - 660-668 G	-80	6	SC
1	930 103 983 05	Cylinder with piston Identification -- / - 668-676 G	81-	6	SC
1	930 103 962 06	Cylinder with piston Identification + / ++ 668-676 G	-80	6	SC
1	930 103 983 06	Cylinder with piston Identification + / ++ 676-684 G	81-	6	SC
(1)	930 103 969 05	Cylinder with piston Identification -- / - 616-624 G		6	TURBO
(1)	930 103 969 04	Cylinder with piston Identification -- / - 616-624 G		6	TURBO
(1)	930 103 969 06	Cylinder with piston Identification + / ++		6	TURBO

Model: 911 78

Model life 1978>>1983

Pos	Part Number	Description	Remark	Qty	Model
1	930 103 966 04	624-632 G Supplier - SCHMIDT - Group 5 Cylinder with piston without Identification	-79	6	SC
1	930 103 966 03	Cylinder with piston Identification -- / -	-80	6	SC
1	930 103 966 04	695-703 G Cylinder with piston Identification + / ++	-80	6	SC
1	930 103 966 02	703-711 G Supplier - SCHMIDT - Group 6 Cylinder with piston without Identification	-79	6	SC
1	930 103 966 05	Cylinder with piston Identification -- / -	-80	6	SC
1	930 103 966 06	695-703 G Cylinder with piston Identification + / ++ 703-711 G Piston rings (MAHLE) Set for 1 Piston	-80	6	SC
2	930 103 963 00	Set of piston rings	-80	6	SC
2	930 103 986 00	Set of piston rings	81-	6	SC
2	930 103 968 00	Set of piston rings Piston rings (SCHMIDT) Set for 1 Piston		6	TURBO
2	930 103 967 00	Set of piston rings	-80	6	SC
3	930 103 375 00	Piston pin (MAHLE)	-79	6	
3	930 103 403 01	Piston pin (SCHMIDT)	-79	6	
3	930 103 388 00	Piston pin (MAHLE)	-79	6	TURBO
4	N 012 278 1	Circlip C 22		12	SC
4	900 908 019 00	Ring C 23		12	TURBO
5	930 104 194 02	Cylinder base gasket 0,25 MM		6	
5	930 104 194 01	Cylinder base gasket Oversize 0.50 mm		6	M 930.10
6	930 104 317 00	Ce-seal ring		6	SC

Model: 911 78

Model life 1978>>1983

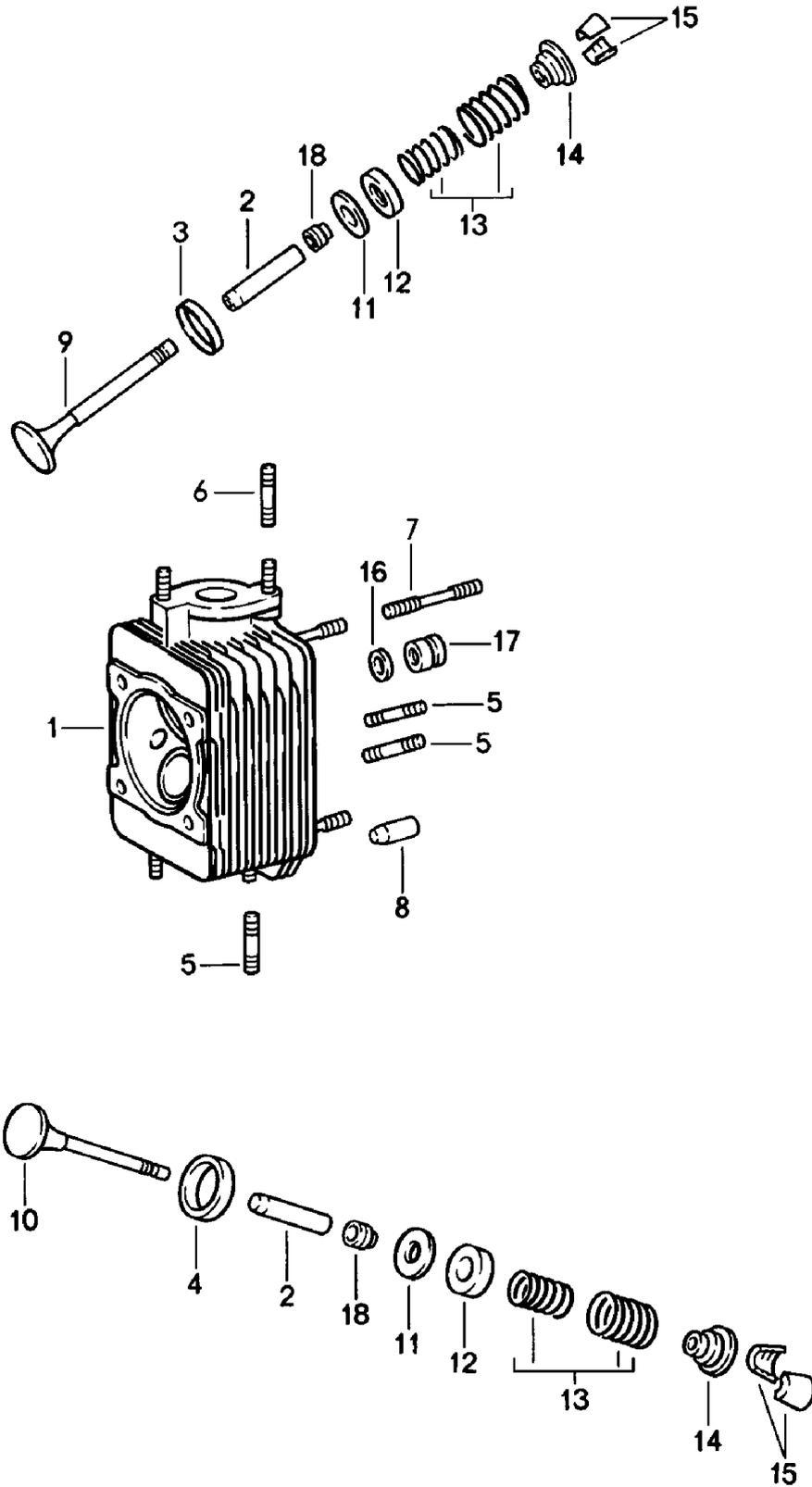

Model: 911 78

Model life 1978>>1983

Pos	Part Number	Description	Remark	Qty	Model
1	930 104 029 08	Cylinder head		6	SC
1	930 104 043 09	Cylinder head without valves		6	TURBO
(1)	930 104 019 05	Cylinder head with valves Ready for installation	-80	6	SC
(1)	930 104 019 08	Cylinder head with valves Ready for installation		6	SC
(1)	930 104 023 09	Cylinder head with valves Ready for installation		6	TURBO
(1)	930 104 023 GX	Cylinder head with valves Ready for installation		6	TURBO
2	930 104 321 50	Valve guide 1st oversize		12	
3	930 104 331 50	Valve seat ring for Intake		6	
4	930 104 335 59	Valve seat ring for Exhaust Oversize 44 \$ M 639 0704 >> M >> 639 4180 M 639 9065 >> M >> 639 9215	-79	6	SC
4	930 104 335 56	Valve seat ring for Exhaust Oversize 46 \$		6	
4		Valve seat ring for Exhaust Oversize 46 \$		6	
5	999 062 006 02	Stud BM 8 X 20		12	
5	999 062 220 02	Stud BM 8 X 20		12	SC
5	999 062 239 02	Stud BM 8 X 30		12	TURBO
6	999 062 009 02	Stud BM 8 X 28		12	SC
6	900 060 105 01	Stud BM 8 X 28		12	SC
6	999 062 178 02	Stud BM 8 X 120		12	TURBO
7	999 062 041 02	Stud BM 8 X 50		24	
8	999 012 006 00	Straight pin		12	
9	930 105 409 13	Intake valve		6	SC
9	930 105 409 01	Intake valve		6	SC
9	964 105 409 06	Intake valve		6	TURBO
9	964 105 409 08	Intake valve		6	TURBO
10	930 105 419 08	Exhaust valve		6	SC
10	930 105 419 51	Exhaust valve		6	SC

Model: 911 78

Model life 1978>>1983

Pos	Part Number	Description	Remark	Qty	Model
10	930 105 419 50	Exhaust valve		6	TURBO
11	930 105 461 00	Washer		X	
11		Washer		X	
12	901 105 463 00	Ring		12	
13	901 105 901 50	Set of valve springs		12	
13	901 105 901 51	Set of valve springs		12	
14	901 105 421 03	Concave washer		12	
15	901 105 417 00	Collet		24	
16	999 031 091 01	Washer		24	
17	901 104 382 02	Nut		24	
17	901 104 382 03	Nut		24	
17	901 104 382 02	Nut		24	
17	901 104 382 03	Nut		24	
18	928 104 193 12	Valve stem seal		12	
(18)	928 104 193 13	Valve stem seal		12	
(18)	964 104 111 07	Valve stem seal		12	
-	000 043 204 48	Sleeve		X	

Model: 911 78

Model life 1978>>1983

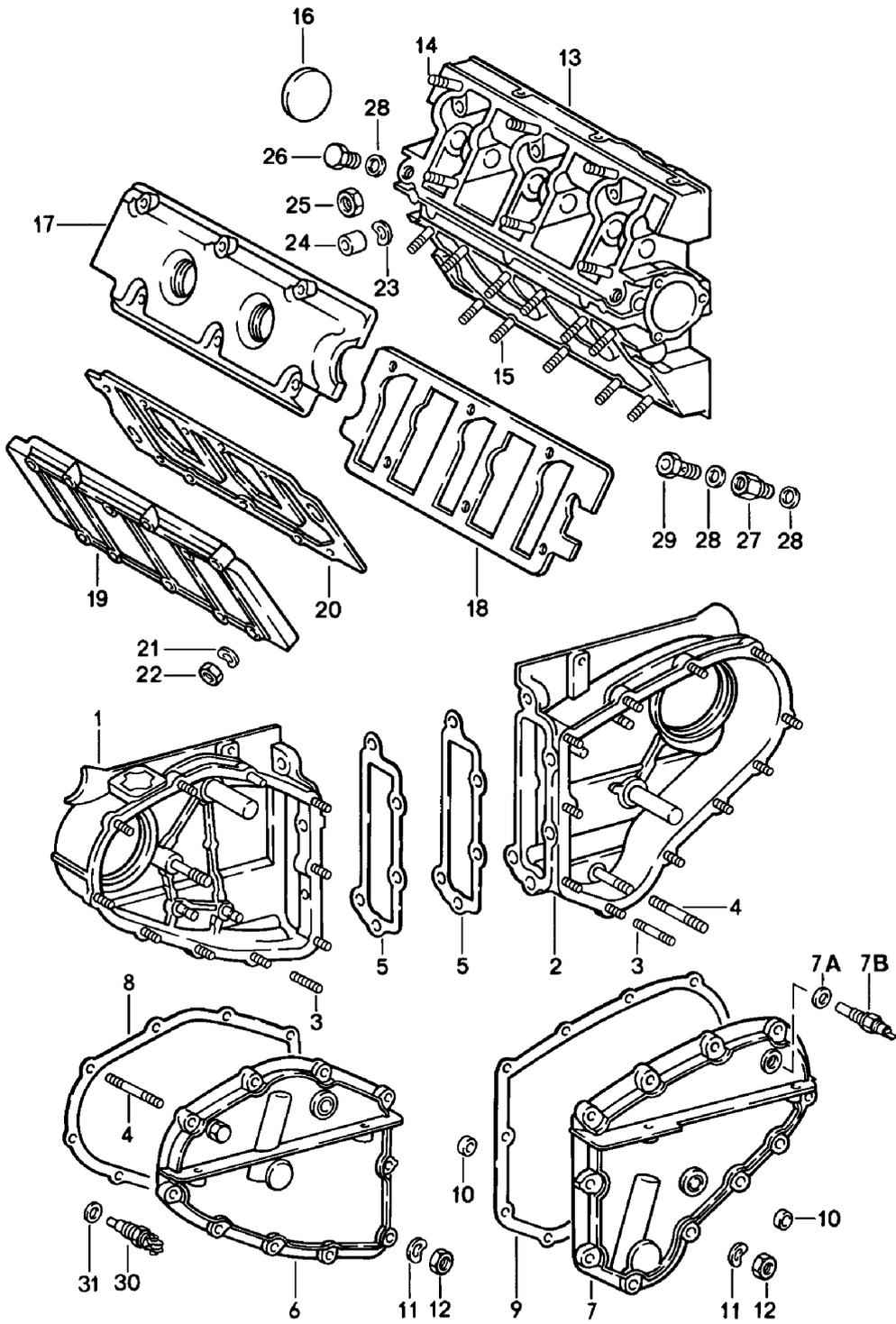

Model: 911 78 Model life 1978>>1983

Pos	Part Number	Description	Remark	Qty	Model
		Camshaft housing			
		Chain case			
1	930 105 061 02	Chain case	/L	1	
2	930 105 062 01	Chain case	/R	1	
3	999 062 102 02	Stud		19	
		BM 6 X 22			
-	999 062 046 02	Stud		2	SC
		BM 8 X 65			
-	999 062 052 02	Stud		2	TURBO
		BM 8 X 42			
4	999 062 255 02	Stud	/L	1	
		BM 8 X 60			
4		Stud	/L	1	
		BM 8 X 60			
4	999 062 041 02	Stud	/R	1	
		BM 8 X 50			
5	930 105 193 00	Gasket		2	
5	930 105 193 05	Gasket		2	
6	930 105 063 01	Lid	/L	1	
		M >> 63D 4069			
		M >> 64D 3716			
		M >> 63D 8154			
		M >> 67D 0711			
6	930 105 063 08	Lid	/L	1	
		M 63D 4070 >>			
		M 64D 3717 >>			
		M 63D 8155 >>			
		M 67D 0712 >>			
-	999 062 010 02	Stud		1	SC
		BM 8 X 35			
7	930 105 064 01	Lid	/R	1	
		M >> 63D 4069			
		M >> 64D 3716			
		M >> 63D 8154			
		M >> 67D 0711			
7	930 105 064 10	Lid	/R	1	
		Use also:			
		M >> 63D 4069			
		M >> 64D 3716			
		M >> 63D 8154			
		M >> 67D 0711			
-	900 123 007 30	Sealing ring		1	
-	N 016 155 3	Screw plug		1	
-	N 016 155 4	Screw plug		1	
7	930 105 064 10	Lid	/R	1	
		M 63D 4070 >>			
		M 64D 3717 >>			
		M 63D 8155 >>			
		M 67D 0712 >>			
7		Lid	/R	1	TURBO
		Use also:			
		M >> 63D 4069			
		M >> 64D 3716			
		M >> 63D 8154			
		M >> 67D 0711			
-	900 123 007 30	Sealing ring		1	
-	N 016 155 3	Screw plug		1	
-	N 016 155 4	Screw plug		1	
7	930 105 064 10	Lid	/R 80-	1	SC
		M 63D 4070 >>			
		M 64D 3717 >>			
		M 63D 8155 >>			
		M 67D 0712 >>			

Model: 911 78

Model life 1978>>1983

Pos	Part Number	Description	Remark	Qty	Model
8	930 105 191 03	Gasket	/L	1	
9	930 105 192 01	Gasket	/R	1	
9	930 105 192 04	Gasket	/R	1	
10	900 036 008 02	Lid 15		2	
11	900 031 011 30	Washer 6,4		19	
-	N 012 241 8	Spring washer B 8		3	SC
-	900 031 014 30	Washer 8,4		2	TURBO
12	900 910 012 02	Lock nut M 6		19	
12	900 910 047 09	Lock nut M 6		19	
-	900 076 025 02	Hexagon nut M 8		3	
-	900 076 064 02	Hexagon nut M 8		3	
13	930 105 021 00	Camshaft housing		2	
14	999 062 009 02	Stud BM 8 X 28		12	
14	900 060 105 01	Stud BM 8 X 28		12	
15	999 062 010 02	Stud BM 8 X 35		22	
-	930 105 362 00	Oil splash tube		2	
-	901 105 379 00	Stopper		4	
16	930 105 161 00	Lid		2	
17	901 105 115 03	Lid		2	
18	930 105 194 00	Gasket		2	
18	930 105 194 02	Gasket		2	
18	930 105 194 04	Gasket		2	
19	930 105 116 00	Lid		2	
19	930 105 116 05	Lid		2	
19	930 105 116 01	Lid	/L	1	TURBO
20	930 105 195 01	Gasket		2	
20	930 105 195 02	Gasket		2	
20	930 105 195 05	Gasket		2	
20	930 105 195 06	Gasket		2	
20	930 105 195 07	Gasket		2	
21	900 031 014 30	Washer 8,4		40	
22	900 084 004 03	Hexagon nut M 8		40	
22	900 084 004 02	Hexagon nut M 8		40	
23	N 012 241 8	Spring washer B 8 X 15		40	
24	901 111 271 00	Nut		6	
25	900 076 025 02	Hexagon nut M 8		34	
25	900 076 064 02	Hexagon nut M 8		34	
26	901 105 374 00	Screw plug		2	
27	901 105 361 01	Intermediate piece		2	
27	901 105 361 02	Intermediate piece		2	
28	900 123 005 00	Sealing ring A 12 X 16		8	
29	999 134 018 02	Banjo bolt A 6		2	
30	911 617 117 00	Temperature switch		1	
31	900 123 007 70	Sealing ring		1	

Model: 911 78

Model life 1978>>1983

Pos	Part Number	Description	Remark	Qty	Model
		A 14 X 18			

Model: 911 78

Model life 1978>>1983

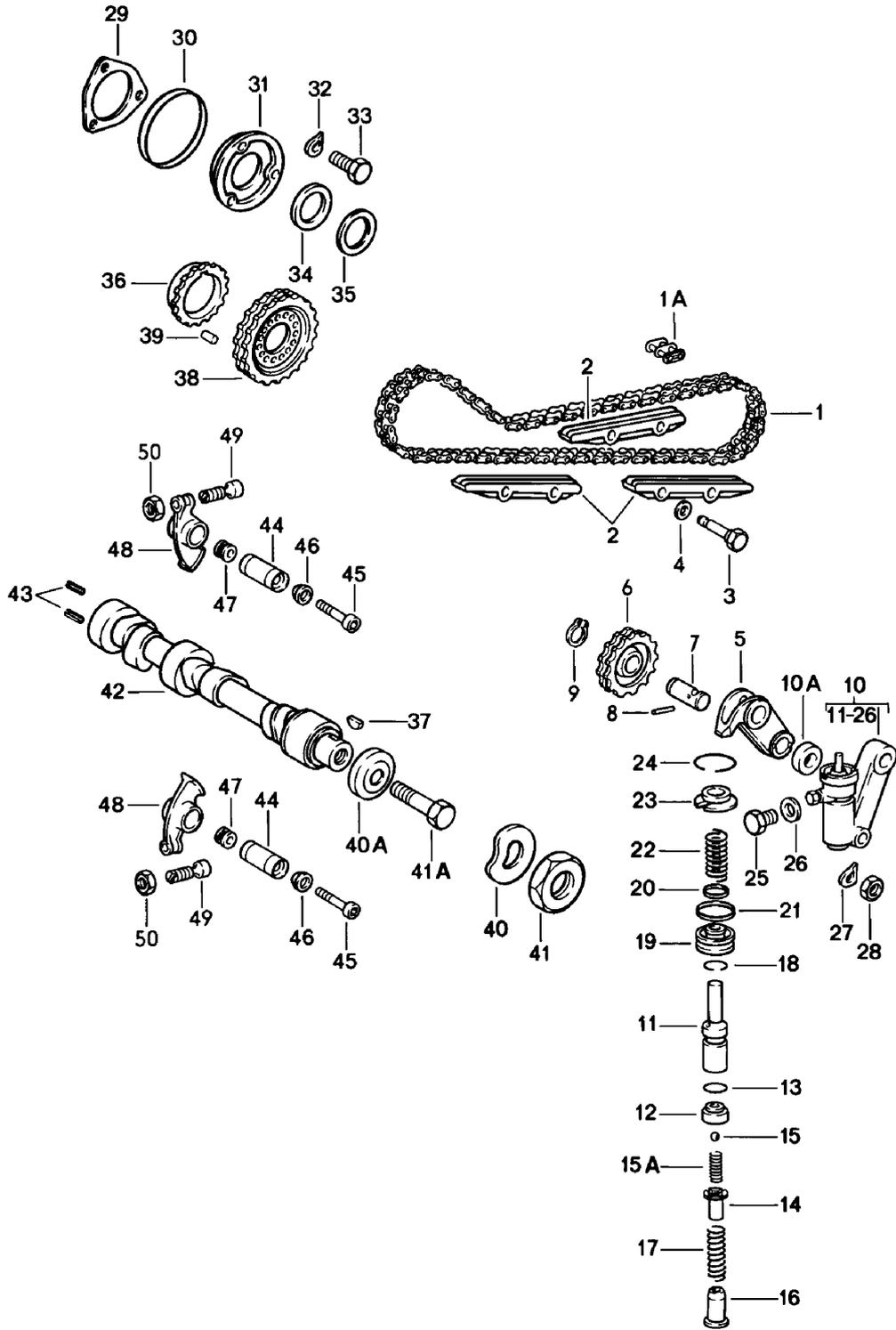

Model: 911 78 Model life 1978>>1983

Pos	Part Number	Description	Remark	Qty	Model
		Valve control Left			
1	901 105 529 00	Timing chain		1	
1	993 105 529 00	Timing chain Closed		1	
1	911 105 529 50	Timing chain Divided with Connecting link		1	
1	911 105 529 51	Timing chain Divided with Connecting link		1	
1A	901 105 530 00	Connecting link Connecting link Only together with 911.105.529.50		1	
2	911 105 222 06	Guide rail		3	
3	901 105 226 03	Bolt		4	
4	900 123 066 30	Sealing ring		4	
5	901 105 505 02	Chain wheel support M >> 640 0450 M >> 630 8135 M >> 630 1091 M >> 630 9033 M >> 670 0106 M >> 689 1301 M >> 689 0684 M >> 670 8023	-79	1	
5	930 105 509 00	Chain wheel support M 640 0451 >> M 630 8136 >> M 630 1092 >> M 630 9034 >> M 670 0107 >> M 689 1302 >> M 689 0685 >> M 670 8024 >>	80-	1	
6	901 105 055 00	Sprocket		1	
7	901 105 056 01	Bolt		1	
7	901 105 056 02	Bolt		1	
8	900 197 010 00	Tensioning sleeve 3 X 22		1	
9	N 012 415 1	Circlip 15 X 1		1	
10	930 105 049 00	Chain adjuster M >> 640 0450 M >> 630 8135 M >> 630 1091 M >> 630 9033 M >> 670 0106 M >> 689 1301 M >> 689 0684 M >> 670 8023		1	
10	930 105 053 00	Chain adjuster M >> 63D 4069 M >> 64D 3716 M >> 63D 8154 M >> 67D 0711		1	
10	930 105 053 04	Chain adjuster M >> 63D 4069 M >> 64D 3716 M >> 63D 8154		1	

Model: 911 78

Model life 1978>>1983

Pos	Part Number	Description	Remark	Qty	Model
(10)	930 105 058 03	M >> 67D 0711 Chain adjuster		1	
		M 63D 4070 >> M 64D 3717 >> M 63D 8155 >> M 67D 0712 >>			
-	930 105 911 00	Chain adjuster 1 set for subsequent installation	-83	1	
10A	930 105 513 00	Spacer sleeve See technical information GRUPPE 1 NR.29A		1	
11	930 105 559 00	Piston		1	
12		Intermediate piece		1	
13		O-ring OR 10-1		1	
14		Guide		1	
15		Ball		1	
15A		Compression spring		1	
16		Spring guide		1	
17	916 105 534 00	Compression spring		1	
17	916 105 534 01	Compression spring		1	
18		Circlip 16		1	
19	930 105 557 00	Piston		1	
20		O-ring CR 8,3 - 2,4		1	
21		O-ring CR 20,3 - 2,4		1	
22	930 105 535 01	Compression spring		1	
23	930 105 568 00	Concave washer		1	
24		Circlip 28		1	
25	930 105 573 00	Bleeder screw		1	
26		Sealing ring 6 X 10		1	
27	N 012 241 8	Spring washer B 8 X 15		1	
28	900 076 025 02	Hexagon nut M 8		1	
28	900 076 064 02	Hexagon nut M 8		1	
29	930 105 197 05	Gasket		1	SC
29	930 105 197 03	Gasket		1	TURBO
30	999 701 468 40	Round seal 67,5 X 75,4 X 4		1	
31	930 105 196 00	Cover		1	
32	N 012 226 5	Spring washer B 6		3	
33	900 075 341 02	Combination screw M 6 X 25		3	
33	900 075 341 01	Combination screw M 6 X 25		3	
34	901 105 562 00	Thrust washer		1	
34	901 105 562 02	Thrust washer		1	
35	901 105 561 00	Shim		X	
36	901 105 583 01	Flange		1	
37	N 012 708 2	Woodruff key 4 X 5		1	
38	901 105 546 02	Sprocket II		1	
38	901 105 546 04	Sprocket II		1	

Model: 911 78 Model life 1978>>1983

Pos	Part Number	Description	Remark	Qty	Model
39	900 243 001 00	Straight pin 6 H 8 X 14		1	
40	900 028 021 01	Spring washer	-81	1	
40	900 028 021 02	Spring washer B 30	-81	1	
40A	993 105 163 50	Washer	82-	1	
41	901 105 172 00	Nut	-81	1	
41A	900 082 072 01	Hexagon-head bolt M 12 X 1,5 X 50	82-	1	
42	930 105 147 08	Camshaft	-81	1	SC
42	930 105 147 10	Camshaft		1	SC
42	930 105 147 16	Camshaft		1	SC
42	930 105 147 17	Camshaft		1	SC
42	930 105 143 00	Camshaft	-81	1	TURBO
42	930 105 143 03	Camshaft		1	TURBO
42		Camshaft		1	TURBO
43	900 095 017 01	Roll pin	SPM	2	SC
43		Roll pin 5 X 24	SPM	2	SC
44	901 105 342 04	Rocker shaft		12	
45	999 067 008 00	Pan-head screw		12	
46	901 105 344 02	Bush		12	
46	901 105 344 03	Bush		12	
47	901 105 376 02	Nut		12	
48	930 105 043 00	Rocker arm		12	
48	930 105 043 02	Rocker arm		12	
49	901 105 370 02	Adjusting screw		12	
50	999 034 005 00	Nut		12	

Model: 911 78

Model life 1978>>1983

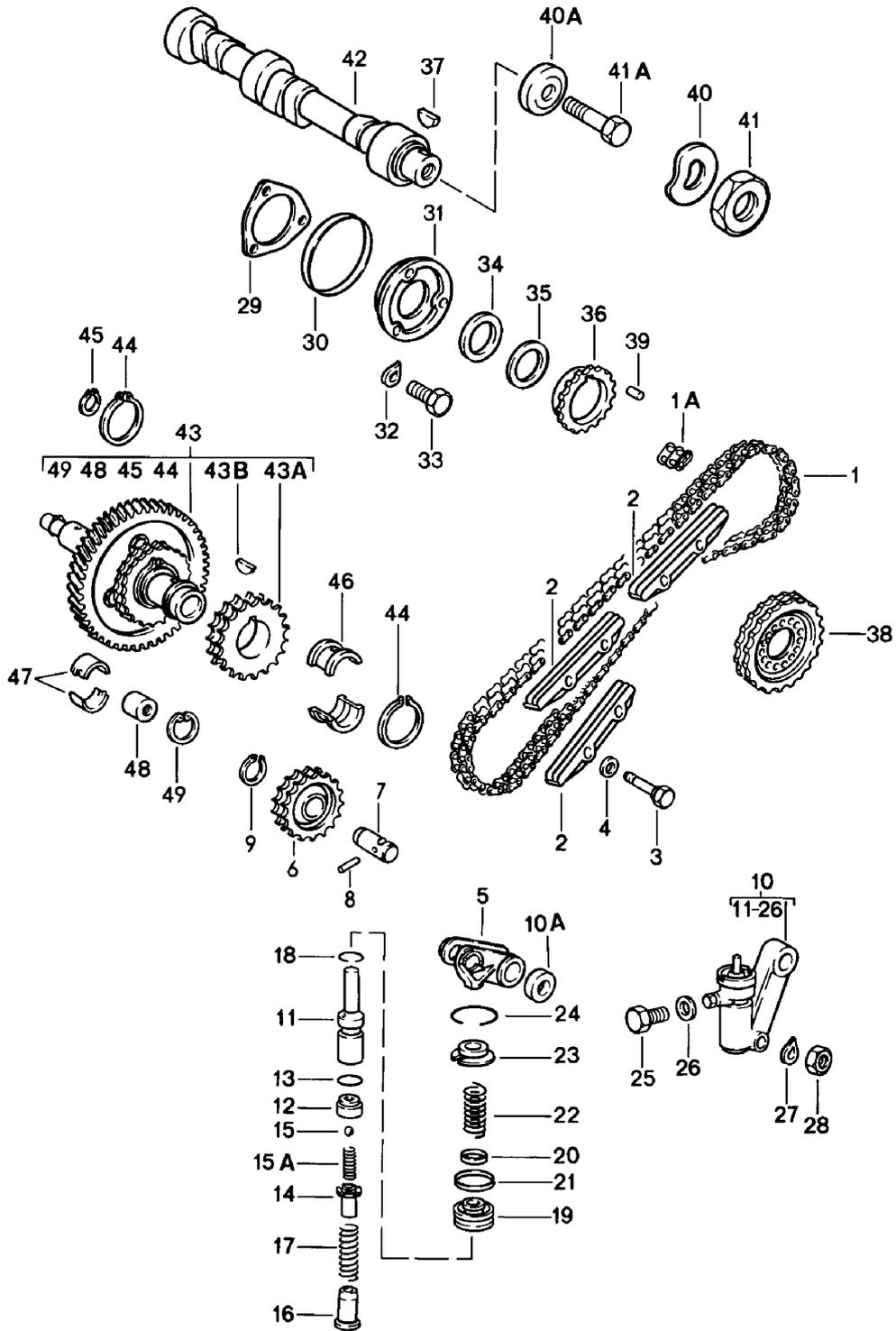

Model: 911 78 Model life 1978>>1983

Pos	Part Number	Description	Remark	Qty	Model
		Valve control Right			
1	901 105 529 00	Timing chain		1	
1	993 105 529 00	Timing chain Closed		1	
1	911 105 529 50	Timing chain Divided with Connecting link		1	
1	911 105 529 51	Timing chain Divided with Connecting link		1	
1A	901 105 530 00	Connecting link Only together with 911.105.529.50		1	
2	911 105 222 05	Guide rail		1	
2	911 105 222 06	Guide rail		2	
3	901 105 226 03	Bolt		4	
4	900 123 066 30	Sealing ring A 10 X 16		4	
5	901 105 506 02	Chain wheel support M >> 640 0450 M >> 630 8135 M >> 630 1091 M >> 630 9033 M >> 670 0106 M >> 689 1301 M >> 689 0684 M >> 670 8023	-79	1	
5	930 105 510 00	Chain wheel support M 640 0451 >> M 630 8136 >> M 630 1092 >> M 630 9034 >> M 670 0107 >> M 689 1302 >> M 689 0685 >> M 670 8024 >>	80-	1	
6	901 105 055 00	Sprocket		1	
7	901 105 056 01	Bolt		1	
7	901 105 056 02	Bolt		1	
8	900 197 010 00	Tensioning sleeve 3 X 22		1	
9	N 012 415 1	Circlip 15 X 1		1	
10	930 105 049 00	Chain adjuster M >> 640 0450 M >> 630 8135 M >> 630 1091 M >> 630 9033 M >> 670 0106 M >> 689 1301 M >> 689 0684 M >> 670 8023		1	
10	930 105 053 00	Chain adjuster M >> 63D 4069 M >> 64D 3716 M >> 63D 8154 M >> 67D 0711		1	
10	930 105 053 04	Chain adjuster M >> 63D 4069 M >> 64D 3716		1	

Model: 911 78 Model life 1978>>1983

Pos	Part Number	Description	Remark	Qty	Model
(10)	930 105 058 03	M >> 63D 8154 M >> 67D 0711 Chain adjuster M 63D 4070 >> M 64D 3717 >> M 63D 8155 >> M 67D 0712 >>		1	
-	930 105 912 00	Chain adjuster 1 set for subsequent installation	-83	1	
-	930 105 912 01	Chain adjuster 1 set for subsequent installation	-83	1	930.07/08 16/17
10A	930 105 513 00	Spacer sleeve See technical information GRUPPE 1 NR. 29A		1	
11	930 105 559 00	Piston		1	
12		Intermediate piece		1	
13		O-ring OR 10 - 1		1	
14		Guide		1	
15		Ball		1	
15A		Compression spring		1	
16		Spring guide		1	
17	916 105 534 00	Compression spring		1	
17	916 105 534 01	Compression spring		1	
18		Circlip 16		1	
19	930 105 557 00	Piston		1	
20		O-ring CR 8,3 - 2,4		1	
21		O-ring CR 20,3 - 2,4		1	
22	930 105 535 01	Compression spring		1	
23	930 105 568 00	Concave washer		1	
24		Circlip 28		1	
25	930 105 573 00	Bleeder screw		1	
26		Sealing ring A 6,5 X 9,5		1	
27	N 012 241 8	Spring washer B 8 X 15		1	
28	900 076 025 02	Hexagon nut M 8		1	
28	900 076 064 02	Hexagon nut M 8		1	
29	930 105 197 05	Gasket		1	SC
29	930 105 197 03	Gasket		1	TURBO
30	999 701 468 40	Round seal 67,5 X 75,4 X 4		1	
31	930 105 196 00	Cover		1	
32	N 012 226 5	Spring washer B 6		3	
33	900 075 341 02	Combination screw M 6 X 25		3	
33	900 075 341 01	Combination screw M 6 X 25		3	
34	901 105 562 00	Thrust washer		1	
34	901 105 562 02	Thrust washer		1	
35	901 105 561 00	Shim		X	
36	901 105 583 01	Flange		1	
37	N 012 708 2	Woodruff key 4 X 5		1	

Model: 911 78 Model life 1978>>1983

Pos	Part Number	Description	Remark	Qty	Model
38	901 105 546 02	Sprocket II		1	
38	901 105 546 04	Sprocket II		1	
39	900 243 001 00	Straight pin 6 H 8 X 14		1	
40	900 028 021 02	Spring washer B 30	-81	1	
40A	993 105 163 50	Washer	82-	1	
41	901 105 172 00	Nut	-81	1	
41A	900 082 072 01	Hexagon-head bolt M 12 X 1,5 X 50	82-	1	
42	930 105 148 08	Camshaft	-81	1	SC
42	930 105 148 10	Camshaft		1	SC
42	930 105 148 16	Camshaft		1	SC
42	930 105 148 17	Camshaft		1	SC
42	930 105 142 00	Camshaft	-81	1	TURBO
42	930 105 142 03	Camshaft		1	TURBO
42	930 105 142 04	Camshaft		1	TURBO
42	930 105 142 05	Camshaft		1	TURBO
43	930 105 013 01	Intermediate shaft Size 0	-79	1	
43	930 105 013 04	Intermediate shaft Size 0		1	
43	930 105 013 01	Intermediate shaft Size 0		1	
43	930 105 013 04	Intermediate shaft Size 0		1	
43A	901 105 125 04	Sprocket		2	
43B	900 118 010 00	Woodruff key		2	
44	900 041 025 01	Circlip 36 X 1,75		2	
45	900 041 026 01	Circlip 13 X 1		1	
46	916 101 137 00	Thrust bearing		2	
46	993 101 137 00	Thrust bearing		2	
46	993 101 137 01	Thrust bearing		2	
47	901 101 135 00	Bearing		2	
48	901 105 275 00	Stopper		1	
49	N 012 296 1	Circlip 16 X 1		1	

Model: 911 78

Model life 1978>>1983

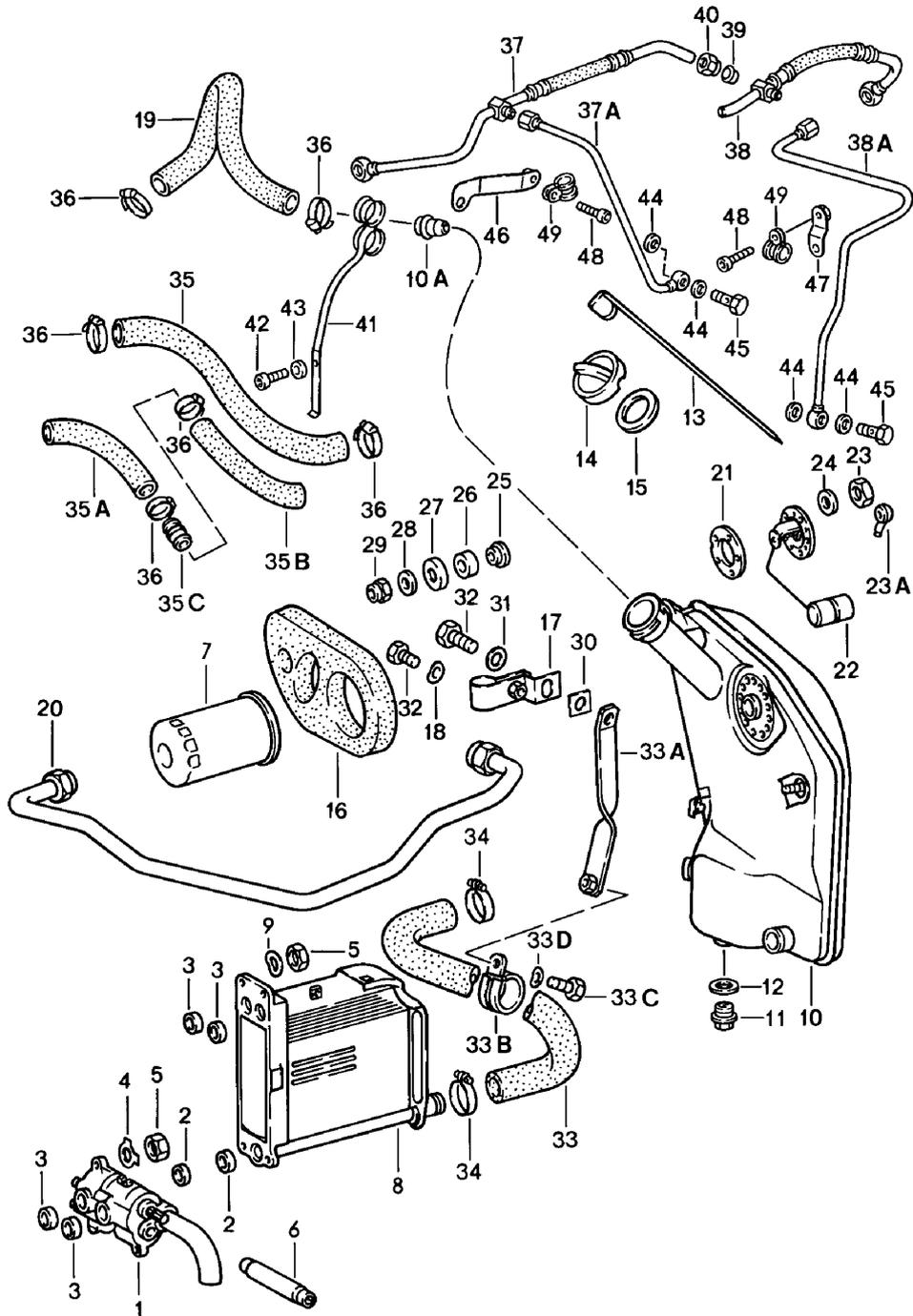

Model: 911 78 Model life 1978>>1983

Pos	Part Number	Description	Remark	Qty	Model
1	911 107 008 01	Engine lubrication Oil pump See technical information GR.1 NR.1/85 Oil pump M >> 63D 4069 M >> 64D 3716 M >> 63D 8154 M >> 67D 0711		1	SC
1	911 107 008 05	Oil pump M 63D 4070 >> M 64D 3717 >> M 63D 8155 >> M 67D 0712 >>		1	SC
1	930 107 008 02	Oil pump M >> 63D 4069 M >> 64D 3716 M >> 63D 8154 M >> 67D 0711		1	TURBO
1	996 107 008 70	Oil pump M 63D 4070 >> M 64D 3717 >> M 63D 8155 >> M 67D 0712 >>		1	TURBO
2	999 704 173 50	Sealing ring		2	
3	999 704 172 50	Sealing ring		4	
4	999 039 001 00	Tab washer		3	
5	900 076 025 02	Hexagon nut M 8		7	
5	900 076 064 02	Hexagon nut M 8		7	
6	901 107 121 00	Connecting shaft		1	SC
6	930 107 143 00	Connecting shaft		1	TURBO
7	930 107 764 01	Oil filter		1	
7	930 107 764 03	Oil filter ROT	-(IND)	1	
8	911 107 041 00	Oil cooler		1	
8	911 107 041 02	Oil cooler		1	
9	N 012 241 8	Spring washer B 8 X 15		4	
10	911 107 006 20	Oil tank		1	SC
10	911 107 006 22	Oil tank Use also:		1	SC
10	911 107 006 24	Oil tank Use also:		1	SC
10	911 107 006 26	Oil tank Use also:		1	SC
10	911 107 006 31	Oil tank Use also:		1	SC
-	999 512 198 02	Hose clamp		1	
-	PCG 512 198 02	Hose clamp		1	
-	034 133 335 D	Cap		1	
10	930 107 006 00	Oil tank	SPM	1	SC
10	930 107 006 03	Oil tank Use also:	SPM	1	SC
10	930 107 006 04	Oil tank Use also:	SPM	1	SC
10	930 107 006 07	Oil tank Use also:	SPM	1	SC
-	944 107 091 01	Oil filler cover		1	
-	930 107 601 02	Adapter		1	
-	900 104 013 02	Union nut		1	
10	930 107 006 00	Oil tank		1	TURBO

Model: 911 78

Model life 1978>>1983

Pos	Part Number	Description	Remark	Qty	Model
10	930 107 006 03	Oil tank		1	
		Use also:			
10	930 107 006 04	Oil tank		1	
		Use also:			
10	930 107 006 07	Oil tank		1	
		Use also:			
-	944 107 091 01	Oil filler cover		1	
-	930 107 601 02	Adapter		1	
-	900 104 013 02	Union nut		1	
-	930 107 601 00	Round socket	(CDN)	1	TURBO
			(AUS)		
-	900 104 015 02	Union nut	(CDN)	1	TURBO
		B1 L10	(AUS)		
10A	930 107 289 00	Restrictor	81-	1	
11	911 107 176 03	Screw plug		1	
11		Screw plug		1	
12	900 123 011 20	Sealing ring		1	
		A 22 X 27			
13	930 107 731 00	Oil level dipstick	-80	1	
13	930 107 731 01	Oil level dipstick	81-	1	
14	911 107 072 02	Fuel tank cap		1	
15	930 107 272 01	Sealing ring		1	
16	911 107 192 03	Gasket		1	
16		Gasket		1	
17	901 501 930 22	Support		1	
18	900 028 003 01	Lock ring		1	
18	N 012 226 5	Spring washer		1	
		A 6			
19	930 107 399 00	Connecting hose		1	SC
		Oil tank			
		Air cleaner			
19	930 107 395 01	Connecting hose		1	TURBO
		Oil tank			
		Air cleaner			
20	930 107 741 11	Oil pipe		1	SC
20		Oil pipe		1	
21	914 201 891 00	Gasket		1	
22	911 641 541 01	Tank gauge	-80	1	
22	911 641 541 02	Tank gauge		1	
23	900 076 027 02	Nut		5	
23	N 011 005 14	Hexagon nut		5	
		M 5			
23	900 076 091 01	Hexagon nut		5	
		M 5			
23A	999 659 011 50	Water protection cap		1	
24	900 025 003 30	Washer		5	
		5,3			
25	901 107 692 00	Washer		2	
26	901 107 693 01	Washer		2	
27	901 107 661 00	Washer		2	
28	900 151 008 02	Washer		2	
		B 8,4			
29	999 090 004 02	Hexagon nut		2	
29	900 084 004 02	Hexagon nut		2	
29	999 090 004 02	Hexagon nut		2	
		M 8			
29	900 084 004 02	Hexagon nut		2	
		M 8			
30	901 501 909 20	Intermediate layer		1	
31	N 011 524 7	Washer		1	
31	N 011 524 27	Washer		1	
31	N 011 524 7	Washer		1	
		6,4			

Model: 911 78 Model life 1978>>1983

Pos	Part Number	Description	Remark	Qty	Model
31	N 011 524 27	Washer 6,4		1	
32	900 075 057 02	Hexagon-head bolt M 6 X 16		2	
32	900 075 057 03	Hexagon-head bolt M 6 X 16		2	
33	911 107 233 00	Suction hose		1	SC
33	930 107 233 02	Suction hose		1	TURBO
33		Suction hose		1	TURBO
33B	930 107 407 03	Pipe clamp		1	SC
33B		Pipe clamp		1	SC
33B		Pipe clamp		1	TURBO
33B		Pipe clamp		1	TURBO
34	999 512 091 00	Hose clamp		2	
35	901 107 394 00	Breather hose Engine Oil tank		1	SC
(35)	930 107 397 01	Line for bleeding Crankcase		1	TURBO
(35)	930 107 393 00	Connecting hose Engine Oil tank		1	TURBO
35A	930 107 394 10	Connecting hose Engine Oil tank	80-	1	SC
35B	930 107 394 09	Connecting hose Engine Oil tank	80-	1	SC
35C	930 110 267 04	Connecting piece	80-	1	SC
36	999 512 356 02	Hose clamp 25-40/9		7	
36	N 024 511 2	Hose clamp		2	TURBO
36	999 512 252 02	Hose clamp		2	TURBO
(37)	901 107 347 01	Oil hose M >> 63D 4069 M >> 64D 3716 M >> 63D 8154 M >> 67D 0711	/L	1	
(37)	901 107 347 02	Oil hose M >> 63D 4069 M >> 64D 3716 M >> 63D 8154 M >> 67D 0711	/L	1	
37	930 107 347 03	Oil hose M 63D 4070 >> M 64D 3717 >> M 63D 8155 >> M 67D 0712 >>		1	
37	930 107 347 04	Oil hose M 63D 4070 >> M 64D 3717 >> M 63D 8155 >> M 67D 0712 >>		1	
37A	930 107 347 02	Oil pipe M 63D 4070 >> M 64D 3717 >> M 63D 8155 >> M 67D 0712 >>		1	
(38)	901 107 348 00	Oil hose M >> 63D 4069 M >> 64D 3716	/R	1	

Model: 911 78 Model life 1978>>1983

Pos	Part Number	Description	Remark	Qty	Model
(38)	901 107 348 02	M >> 63D 8154 M >> 67D 0711 Oil hose	/R	1	
38	930 107 348 11	M >> 63D 4069 M >> 64D 3716 M >> 63D 8154 M >> 67D 0711 Oil hose		1	
38	930 107 348 12	M 63D 4070 >> M 64D 3717 >> M 63D 8155 >> M 67D 0712 >> Oil hose		1	
38A	930 107 348 08	M 63D 4070 >> M 64D 3717 >> M 63D 8155 >> M 67D 0712 >> Oil pipe		1	
38A	930 107 348 09	M 63D 4070 >> M 64D 3717 >> M 63D 8155 >> M 67D 0712 >> Oil pipe		1	(QI-1/87)
38A	930 107 348 14	M 63D 4070 >> M 64D 3717 >> M 63D 8155 >> M 67D 0712 >> Oil pipe		1	(QI-1/87)
38A	930 107 348 09	M 63D 4070 >> M 64D 3717 >> M 63D 8155 >> M 67D 0712 >> Oil pipe		1	(QI-1/87)
39	N 020 825 1	Cutting ring		2	
39		Cutting ring		2	
40	900 104 003 02	LL 8 Union nut		2	
40	900 104 003 03	ALL 8 Union nut		2	
41	930 207 356 00	Retaining bracket	80-	1	SC
42	N 010 215 13	Hexagon-head bolt M 6 X 15	80-	1	SC
43	N 011 524 7	Washer 6,4	80-	1	SC
43	N 011 524 27	Washer 6,4	80-	1	SC
44	900 123 115 30	Sealing ring A 8 X 11,5 M 63D 4070 >> M 64D 3717 >> M 63D 8155 >> M 67D 0712 >>		4	
45	N 021 073 1	Banjo bolt LL 3-5 M 63D 4070 >> M 64D 3717 >> M 63D 8155 >> M 67D 0712 >>		2	

Model: 911 78

Model life 1978>>1983

Pos	Part Number	Description	Remark	Qty	Model
46	930 107 341 00	Support	/L	1	
47	930 107 342 01	Support	/R	1	
48	900 119 059 02	Pan-head screw M 4 X 10		2	
48	900 119 088 01	Pan-head screw M 4 X 10		2	
49	999 511 174 02	Pipe clamp 4/9		2	
49	PCG 511 174 02	Pipe clamp 4/9		2	

Model: 911 78

Model life 1978>>1983

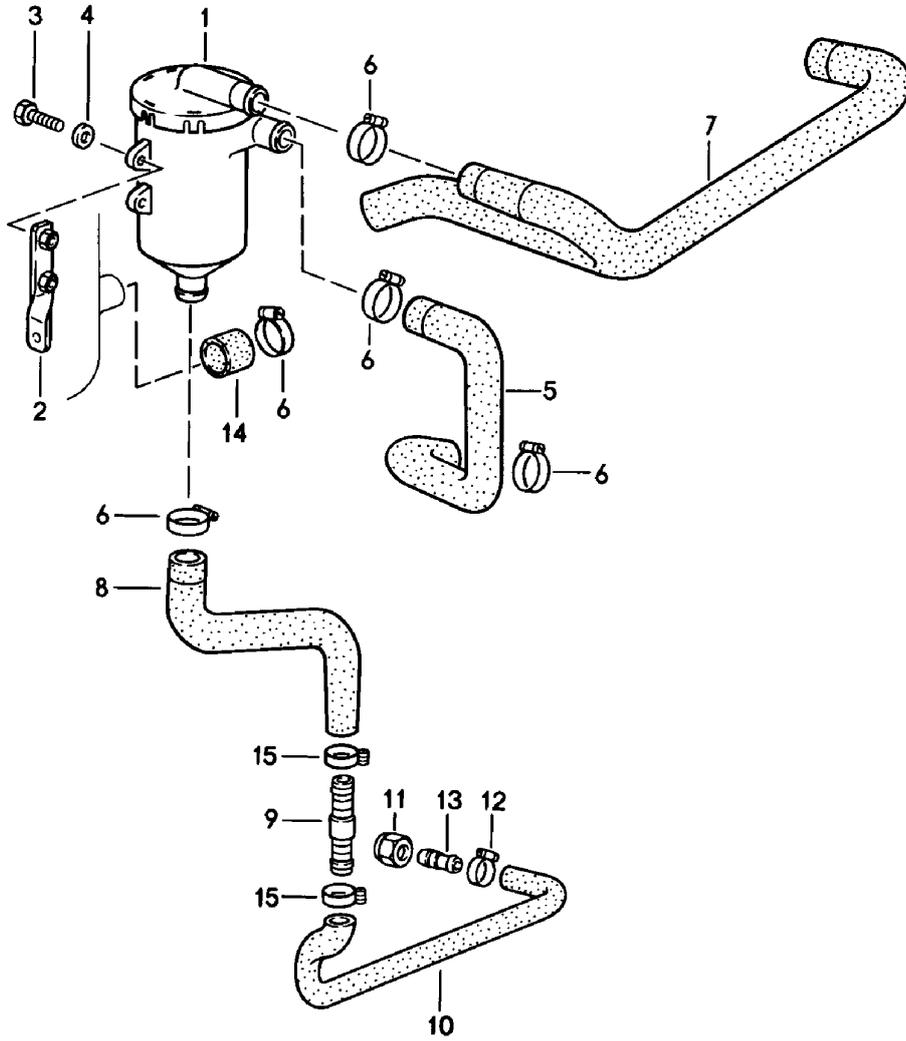

Model: 911 78 Model life 1978>>1983

Pos	Part Number	Description	Remark	Qty	Model
		Oil separator	81-		TURBO 930.60/66
1	930 107 321 01	Oil separator		1	
1		Oil separator		1	
2	930 107 323 00	Support		1	
3	N 010 217 9	Hexagon-head bolt M 6X20		2	
4	900 223 003 02	Washer 6,4		2	
5	930 107 391 00	Hose		1	
6	N 024 511 2	Hose clamp		6	
6	999 512 252 02	Hose clamp		6	
7	930 107 395 04	Hose		1	
7	930 107 995 00	Hose		1	
8	930 107 389 02	Hose		1	
9	930 110 267 00	Hose connection		1	
9		Hose connection		1	
10	930 107 389 03	Hose		1	
11	900 104 015 02	Union nut		1	
12	900 272 003 02	Hose clamp		1	
12	999 512 554 00	Hose clamp		1	
13	999 230 068 02	Hose connection		1	
14	930 107 711 00	Cap		1	
15	999 512 346 00	Hose clamp		2	

Model: 911 78

Model life 1978>>1983

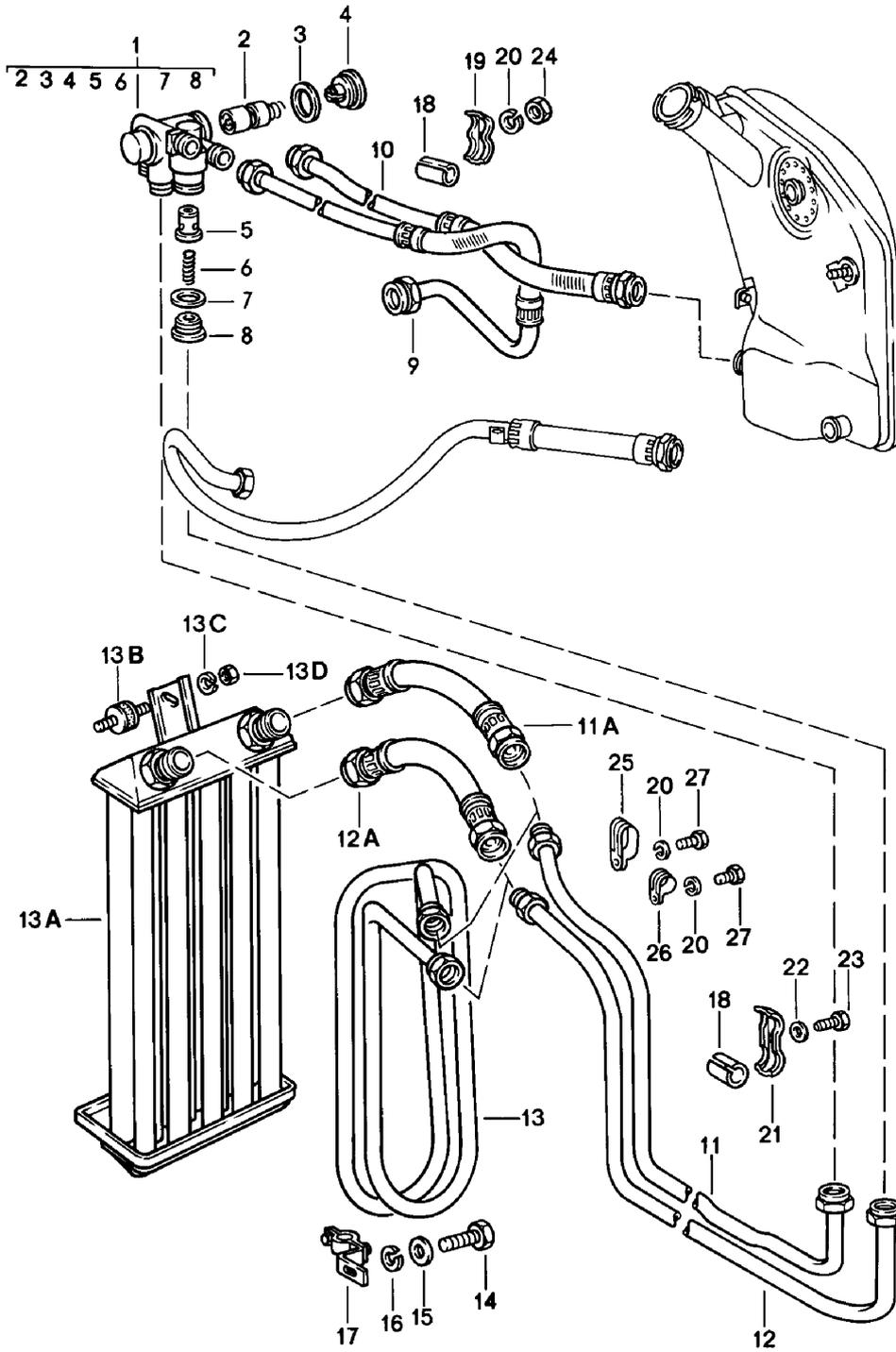

Model: 911 78

Model life 1978>>1983

Pos	Part Number	Description	Remark	Qty	Model
		Engine lubrication			
		Radiator coil			
1	930 107 017 00	Regulator housing		1	
2	930 107 155 00	Regulator insert		1	
3	900 123 136 30	Sealing ring		1	
		A 42 X 49			
4	911 107 155 00	Screw plug		1	
5	930 107 076 00	Piston		1	
6	900 280 008 00	Compression spring		1	
7	900 123 075 30	Sealing ring		1	
		A 32 X 38			
8	916 107 276 00	Screw plug		1	
9	911 107 743 10	Oil pipe		1	SC
9	911 107 743 12	Oil pipe		1	SC
9	930 107 743 10	Oil pipe		1	TURBO
10	911 107 730 11	Oil pipe		1	
11	930 207 046 01	Return pipe		1	
11	930 207 046 02	Return pipe		1	
11A	930 207 113 00	Oil pipe	80-	1	
11A	930 207 113 04	Oil pipe	80-	1	
11A	930 207 113 05	Oil pipe	80-	1	
12	930 207 045 00	Intake tube	-80	1	
12	930 207 045 01	Intake tube	81-	1	
12	930 207 045 03	Intake tube	81-	1	
12A	930 207 111 00	Oil pipe	80-	1	
(12A)	930 207 111 05	Oil pipe	80-	1	
(12A)	930 207 111 06	Oil pipe	80-	1	
13	911 207 050 01	Radiator coil	-79	1	
13A	930 207 053 02	Oil cooler	80-	1	
		See technical information			
		GR.1 NR.2/84			
13A	930 207 053 04	Oil cooler	80-	1	
		See technical information			
		GR.1 NR.2/84			
13B	930 110 194 00	Bonded rubber buffer	80-	3	
13B	999 703 263 00	Bonded rubber buffer	80-	3	
13C	900 025 007 02	Washer	80-	6	
		8,4			
13C	900 025 007 03	Washer	80-	6	
		8,4			
13D	900 910 022 02	Lock nut	80-	6	
		M 8			
14	900 075 085 02	Hexagon-head bolt	-79	1	
		M 8 X 20			
15	900 025 007 02	Washer		1	
		8,4			
15	900 025 007 03	Washer		1	
		8,4			
16	900 027 015 02	Lock ring	-79	1	
		B 8			
16	900 027 015 03	Lock ring		1	
		B 8			
17	911 207 051 00	Clip	-79	1	
18	911 207 302 00	Hose		2	
19	911 207 237 00	Support		1	
20	N 012 006 4	Lock ring		4	
		B 6			
21	911 207 303 00	Support		3	
22	900 151 007 02	Washer		3	
		B 7,4			
22	900 151 007 03	Washer		3	
		B 7,4			
23	900 187 032 02	Tapping screw		3	SC

Model: 911 78

Model life 1978>>1983

Pos	Part Number	Description	Remark	Qty	Model
23	900 187 028 02	BZ 6,3 X 32 Tapping screw		3	TURBO
24	900 076 010 02	BZ 6,3 X 25 Nut		1	
24	900 076 010 0B	M 6 Nut		1	
25	999 511 084 02	M 6 Pipe clamp		1	
26	999 511 080 02	1100 2 X 22/15 Clamp		1	
27	N 010 217 9	1100 22/15 Hexagon-head bolt		3	
		M 6 X 20			

Model: 911 78

Model life 1978>>1983

SPORTOMATIC 925

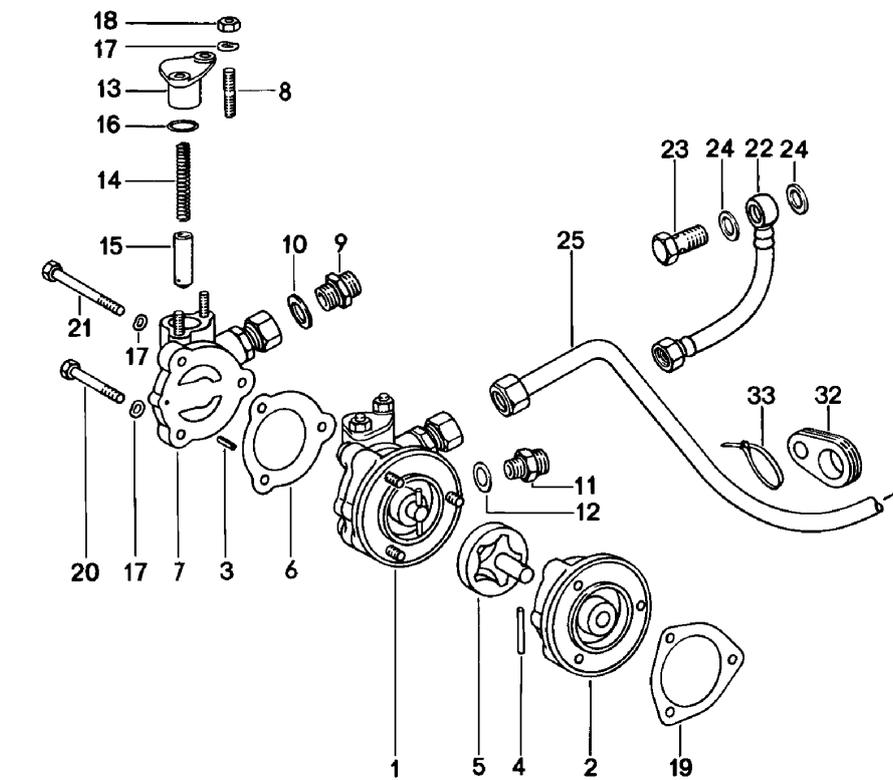
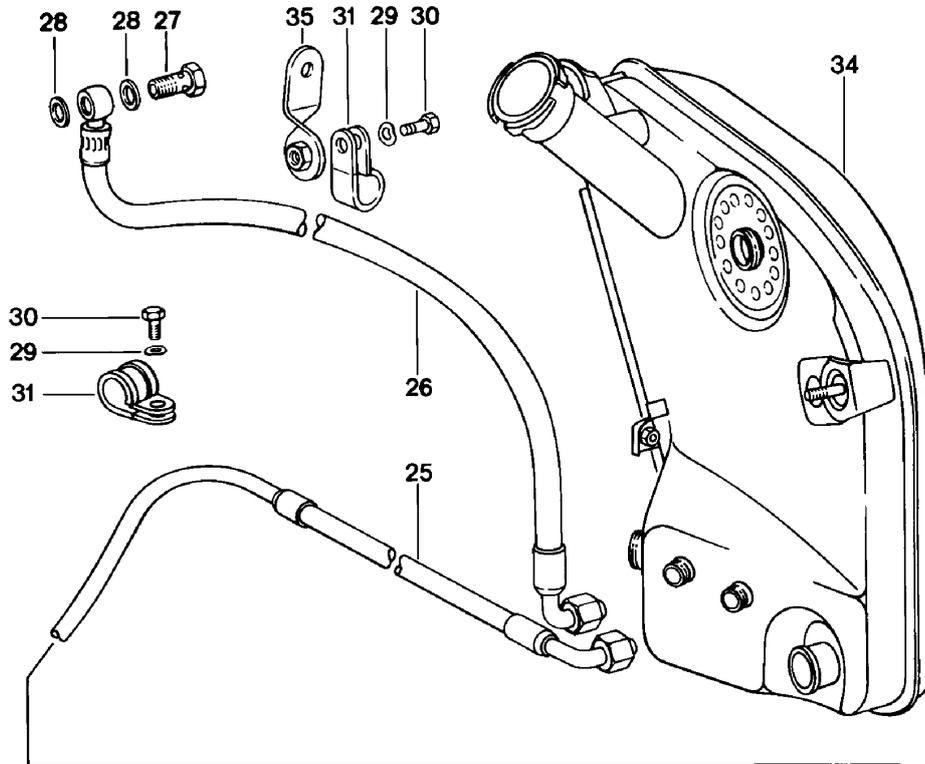

Model: 911 78 Model life 1978>>1983

Pos	Part Number	Description	Remark	Qty	Model
		Supplier -SPM-			
		Oil supply for Converter			
1	905 107 006 04	Oil pump		1	
2	905 107 101 03	Rotor housing		1	
3	900 197 017 00	Tensioning sleeve 4 X 14		1	
4	900 302 001 00	Straight pin 4M 6 X 32		1	
5	905 107 901 01	Rotor set		1	
6	905 107 191 02	Gasket		1	
6	905 107 191 03	Gasket		1	
7	905 107 015 04	Lid		1	
8	999 062 002 02	Stud BM 6 X 15		2	
9	999 099 011 02	Union AM-10-11 ST.		1	
10	900 123 008 30	Sealing ring A 14 X 20		1	
11	999 136 007 02	Union		1	
12	900 123 116 30	Sealing ring A 12 X 15,5		1	
13	905 107 141 03	Flat connector		1	
14	905 107 142 01	Compression spring		1	
15	905 107 143 01	Slide		1	
16	999 701 135 50	O-ring R 15 X 2,5		1	
17	N 012 226 5	Spring washer B 6		5	
18	900 076 010 02	Nut M 6		2	
18	900 076 010 0B	Nut M 6		2	
19	930 105 197 05	Gasket		1	
20	900 074 111 02	Hexagon-head bolt M 6 X 50		2	
21	900 074 022 02	Hexagon-head bolt M 6 X 65		1	
22	925 125 038 07	Pressure pipe PUMPE - Converter housing		1	
23	999 134 012 02	Banjo bolt		1	
24	900 123 006 30	Sealing ring A 12 X 18		2	
25	911 125 335 01	Oil pipe		1	
-	999 104 007 02	Order also: Union nut		1	
-	999 103 001 02	Collet		1	
26	925 301 117 11	Return line		1	
27	900 123 101 30	Sealing ring A 10		1	
28	900 123 019 30	Sealing ring		2	
29	N 011 524 7	Washer		2	
29	N 011 524 27	Washer		2	
30	N 010 215 13	Hexagon-head bolt M 6 X 15		2	
31	N 020 607 1	Clamp		2	
32	905 107 173 00	Spacer rubber		2	
33	999 513 002 40	Tie-wrap		2	
33	N 020 910 4	Tie-wrap		2	
33	999 513 003 40	Tie-wrap		2	

Model: 911 78

Model life 1978>>1983

Pos	Part Number	Description	Remark	Qty	Model
34	930 107 006 00	Oil tank		1	
34	930 107 006 03	Oil tank		1	
		Use also:			
34	930 107 006 04	Oil tank		1	
		Use also:			
34	930 107 006 07	Oil tank		1	
		Use also:			
-	944 107 091 01	Oil filler cover		1	
-	930 107 601 02	Adapter		1	
35	925 301 018 00	Fastening clip		1	

Model: 911 78

Model life 1978>>1983

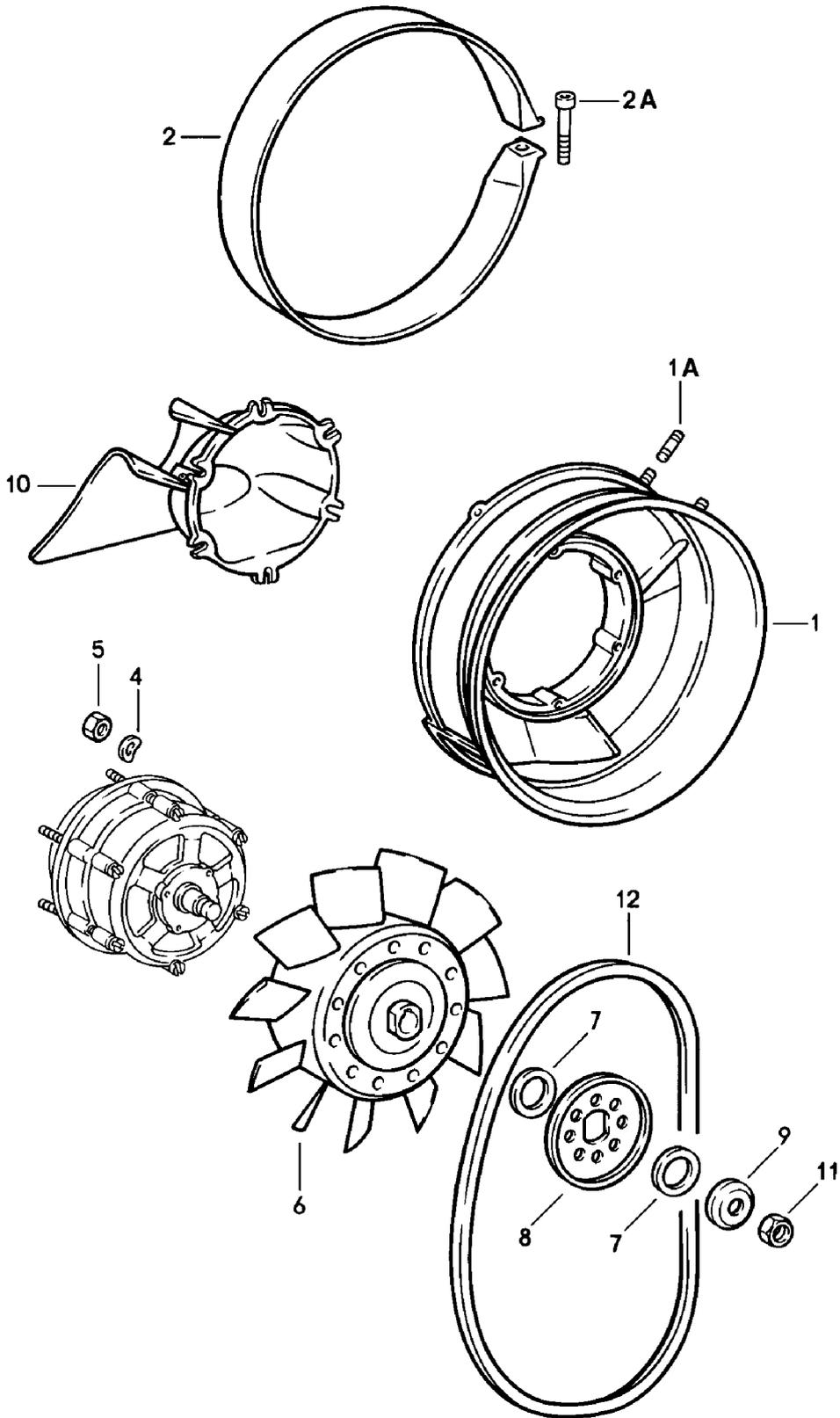

Model: 911 78 Model life 1978>>1983

Pos	Part Number	Description	Remark	Qty	Model
1	930 106 005 00	Air cooling Fan housing M >> 639 9201 M >> 639 3868	-79	1	SC
1	930 106 006 00	Fan housing M 639 9202 >> M 639 3869 >>	-79	1	SC
1		Fan housing	80-	1	SC
1		Fan housing		1	TURBO
1A	999 062 006 02	Stud BM 8 X 20		2	
2	964 106 251 20	Clip		1	
2A	N 014 715 3	Pan-head screw M 8 X 45		1	
2A	900 067 103 01	Pan-head screw M 8 X 45		1	
2A	900 067 020 02	Pan-head screw M 8 X 50		1	
2A	900 067 362 01	Pan-head screw M 8 X 50		1	
4	N 012 226 5	Spring washer B 6		6	
5	900 076 010 02	Nut M 6		6	
5	900 076 010 0B	Nut M 6		6	
6	930 106 011 01	Impeller M >> 639 9201 M >> 639 3868	-79	1	SC
6	930 106 012 00	Impeller M 639 9202 >> M 639 3869 >>	-79	1	SC
6	930 106 012 01	Impeller M 639 9202 >> M 639 3869 >>		1	SC
6	930 106 012 00	Impeller		1	SC
6	930 106 012 01	Impeller		1	SC
6	930 106 012 00	Impeller		1	TURBO
6	930 106 012 01	Impeller		1	TURBO
6	930 106 012 00	Impeller		1	TURBO
6	930 106 012 01	Impeller		1	TURBO
7	930 106 564 00	Shim		X	
8	911 106 208 00	Pulley		1	SC
8	930 106 209 02	Pulley half		1	TURBO
9	901 603 428 00	Tensioning cap	-81	1	
9	901 603 428 01	Tensioning cap		1	
9	911 603 428 01	Tensioning cap	82-	1	
10	911 106 033 03	Hub extension		1	SC
10	930 106 033 00	Hub extension		1	TURBO
10	911 106 033 04	Hub extension		1	
10	911 106 033 05	Hub extension		1	
11	901 603 905 00	Hexagon nut M 16 X 1	-81	1	
11	901 603 905 01	Hexagon nut M 16 X 1		1	
11	928 603 904 00	Set of fastening parts M 17 X 1,5	82-	1	
12	999 192 097 50	Narrow v-belt 9,5 X 725 M >> 639 9201 M >> 639 3868	-79	1	SC
12	999 192 176 50	Narrow v-belt 9,5 X 710	-79	1	SC

Model: 911 78

Model life 1978>>1983

Pos	Part Number	Description	Remark	Qty	Model
12	999 192 176 5A	M 639 9202 >> M 639 3869 >> Narrow v-belt 9,5 X 710		1	SC
12	999 192 176 50	M 639 9202 >> M 639 3869 >> Narrow v-belt 9,5 X 710	80-	1	SC
12	999 192 176 5A	Narrow v-belt 9,5 X 710	80-	1	SC
12	999 192 313 5A	Narrow v-belt 9,5 X 695	80-	1	SC
12	999 192 176 50	Narrow v-belt 9,5 X 710		1	TURBO
12	999 192 176 5A	Narrow v-belt 9,5 X 710		1	TURBO
12	999 192 313 5A	Narrow v-belt 9,5 X 695		1	TURBO

Model: 911 78

Model life 1978>>1983

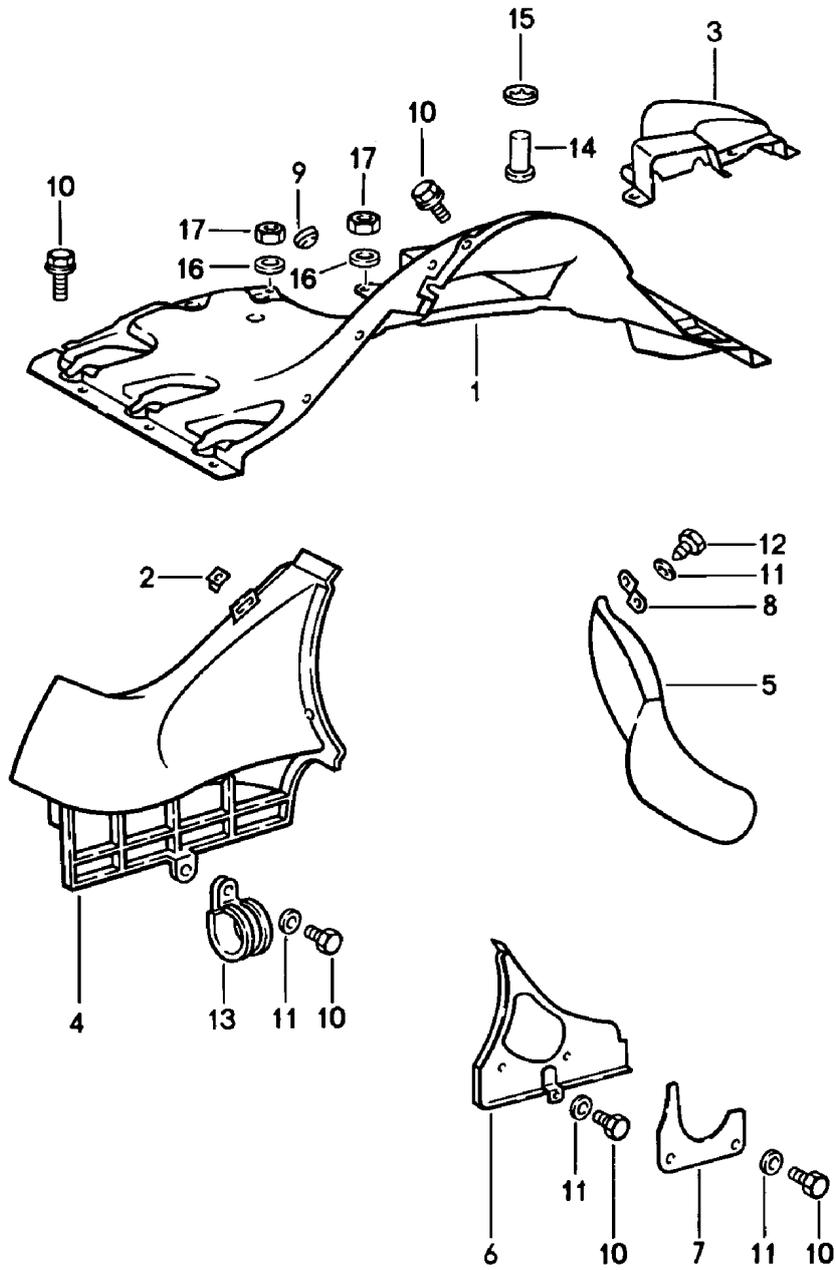

Model: 911 78

Model life 1978>>1983

Pos	Part Number	Description	Remark	Qty	Model
1	930 106 041 00	Air guide Air guide Red	-78	1	SC
1	PCG 106 041 04	Air guide Black		1	SC
1	930 106 041 12	Air guide	-78	1	TURBO
1	930 106 041 13	Air guide It is necessary to rework		1	TURBO
2	999 507 003 02	Speed nut B 6,3		5	
2	999 507 003 01	Speed nut B 6,3		5	
3	911 106 406 00	Air guide		1	
4	930 106 326 01	Hot air socket		1	SC
(4)	930 106 321 01	Hot air socket		1	TURBO
(4)	930 106 021 50	Hot air socket		1	TURBO
5	911 106 327 00	Hot air socket		1	TURBO
6	911 106 036 01	Cover plate		1	SC
(6)	911 106 036 00	Cover plate		1	TURBO
7	911 106 827 00	Closing plate		1	TURBO
8	911 106 331 00	Support		1	TURBO
9	999 703 092 40	Stopper 9 X 18,5/14		1	
10	999 075 039 02	Combination screw M 6 X 12		10	
10	999 075 039 0C	Combination screw M 6 X 12		10	
10	999 143 004 08	Combination screw M 6 X 12		8	
10	999 143 004 01	Combination screw M 6 X 12		8	
10	999 075 039 0C	Combination screw M 6 X 12		8	
10	900 075 057 02	Hexagon-head bolt M 6 X 16		2	
10	900 075 057 03	Hexagon-head bolt M 6 X 16		2	
10	900 075 014 02	Hexagon-head bolt M 6 X 18		2	
10	900 075 014 03	Hexagon-head bolt M 6 X 18		2	
11	N 011 524 7	Washer 6,4		8	
11	N 011 524 27	Washer 6,4		8	
11	999 025 108 02	Washer 6,4 X 14		15	
11	N 011 666 7	Washer B 6,4		2	
11	999 025 070 02	Washer 6,1		2	
12	900 187 015 02	Hexagon-head tapping screw B 6,3 X 16		4	
12	900 187 027 02	Hexagon-head tapping screw BZ 6,3 X 23		1	TURBO
13	999 511 069 02	Clamp		1	SC
13	999 511 069 0C	Clamp		1	SC
16	N 011 524 7	Washer A 6,4		2	
16	N 011 524 27	Washer A 6,4		2	
17	900 076 010 02	Nut M 6		2	

Model: 911 78

Model life 1978>>1983

Pos	Part Number	Description	Remark	Qty	Model
17	900 076 010 0B	Nut M 6		2	

Model: 911 78

Model life 1978>>1983

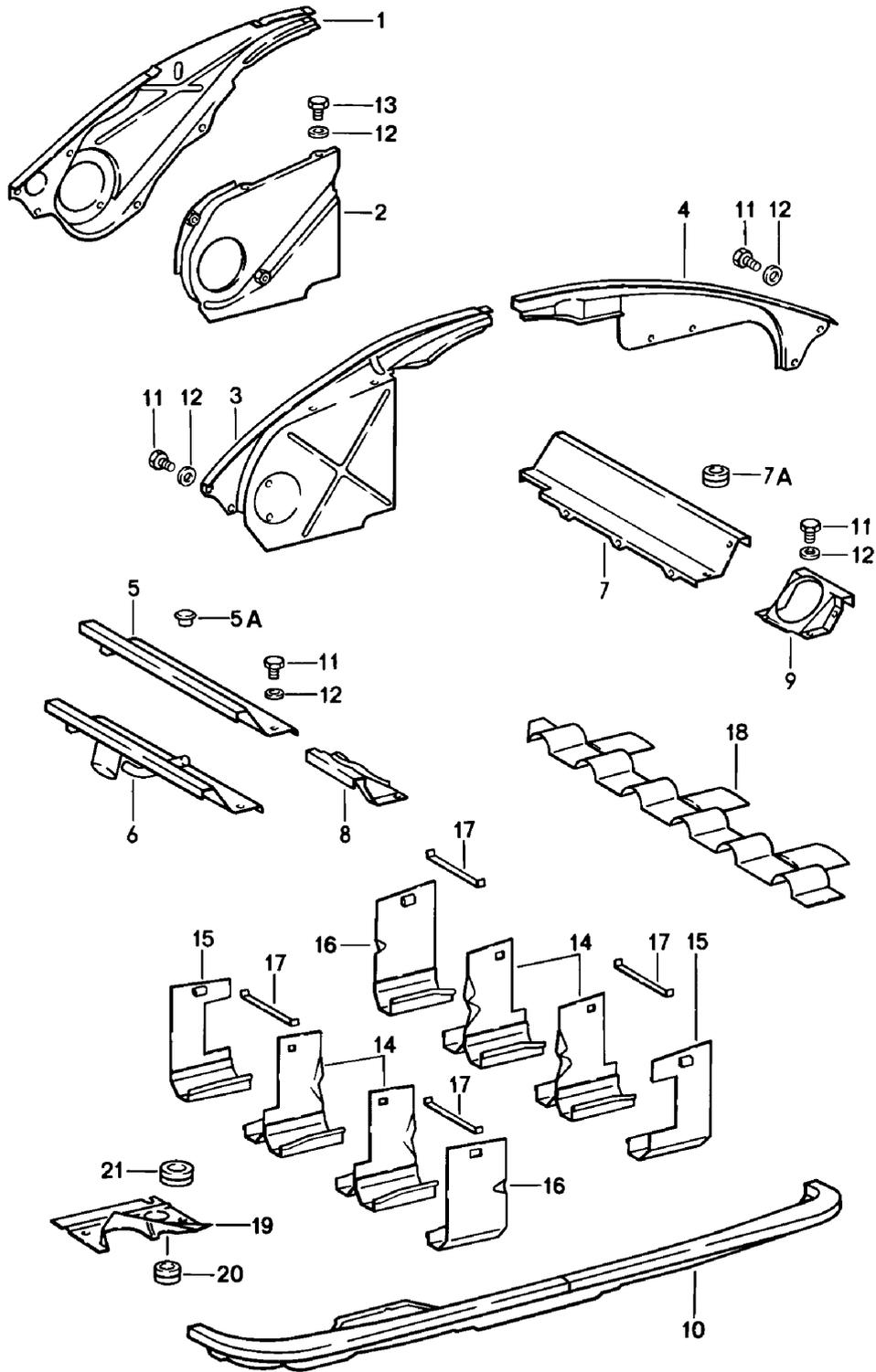

Model: 911 78 Model life 1978>>1983

Pos	Part Number	Description	Remark	Qty	Model
		Air guide			
		Engine cover			
1	930 106 705 01	Engine cover		1	TURBO
2	930 106 707 01	Engine cover		1	TURBO
3	901 106 081 04	Engine cover		1	SC
3	905 106 081 04	Engine cover	SPM	1	SC
4	911 106 802 00	Engine cover		1	SC
4	911 106 802 04	Engine cover		1	SC
4	930 106 805 00	Engine cover		1	TURBO
5	901 106 083 00	Engine cover		1	SC
5	911 106 083 01	Engine cover		1	SC
		Use also:			
		999 703 224 40			
5A	999 703 224 40	Cap		1	SC
		\$ 20,5			
6	930 106 703 01	Engine cover		1	TURBO
7	901 106 084 00	Engine cover		1	
7	930 106 084 00	Engine cover	(J) -79	1	SC (CALIF)
7		Engine cover		1	TURBO
7	930 106 084 03	Engine cover	81-	1	TURBO
7		Engine cover	81-	1	TURBO
		Together with			
		Oil separator			
7A	999 702 114 50	Grommet	81-	1	TURBO
8	911 106 853 00	Cover		1	SC
8	901 106 825 00	Cover		1	TURBO
9	901 106 826 00	Cover		1	SC
9	930 106 826 01	Cover		1	TURBO
9		Cover		1	TURBO
10	911 106 085 04	Engine cover	78	1	SC
10	911 106 085 05	Engine cover	-79	1	SC
					M399
10	930 106 085 02	Engine cover	79-	1	SC
10	930 106 085 04	Engine cover	80-	1	SC
					M559
10	930 106 851 05	Engine cover		1	TURBO
10	930 106 851 07	Engine cover		1	TURBO
					M559
10	930 106 851 12	Engine cover		1	TURBO
					M559
11	999 075 039 02	Combination screw		39	
		M 6 X 12			
11	999 075 039 0C	Combination screw		39	
		M 6 X 12			
12	N 011 524 7	Washer		41	
		6,4			
12	N 011 524 27	Washer		41	
		6,4			
13	N 010 208 5	Hexagon-head bolt		2	TURBO
		M 6 X 8			
14	930 106 023 00	Baffle plate		4	SC
14	930 106 023 01	Baffle plate		4	TURBO
15	930 106 221 00	Baffle plate		2	SC
15	930 106 221 01	Baffle plate		2	TURBO
16	930 106 222 00	Baffle plate		2	SC
16	930 106 222 01	Baffle plate		2	TURBO
17	930 106 228 00	Leaf spring		6	
18	930 106 301 00	Cover plate		2	SC
19	930 106 852 01	Cover		1	TURBO
20	930 106 175 00	Rubber sleeve		1	TURBO
		21,5 \$			
21	930 106 176 00	Rubber sleeve		1	TURBO
		34 \$			

Model: 911 78

Model life 1978>>1983

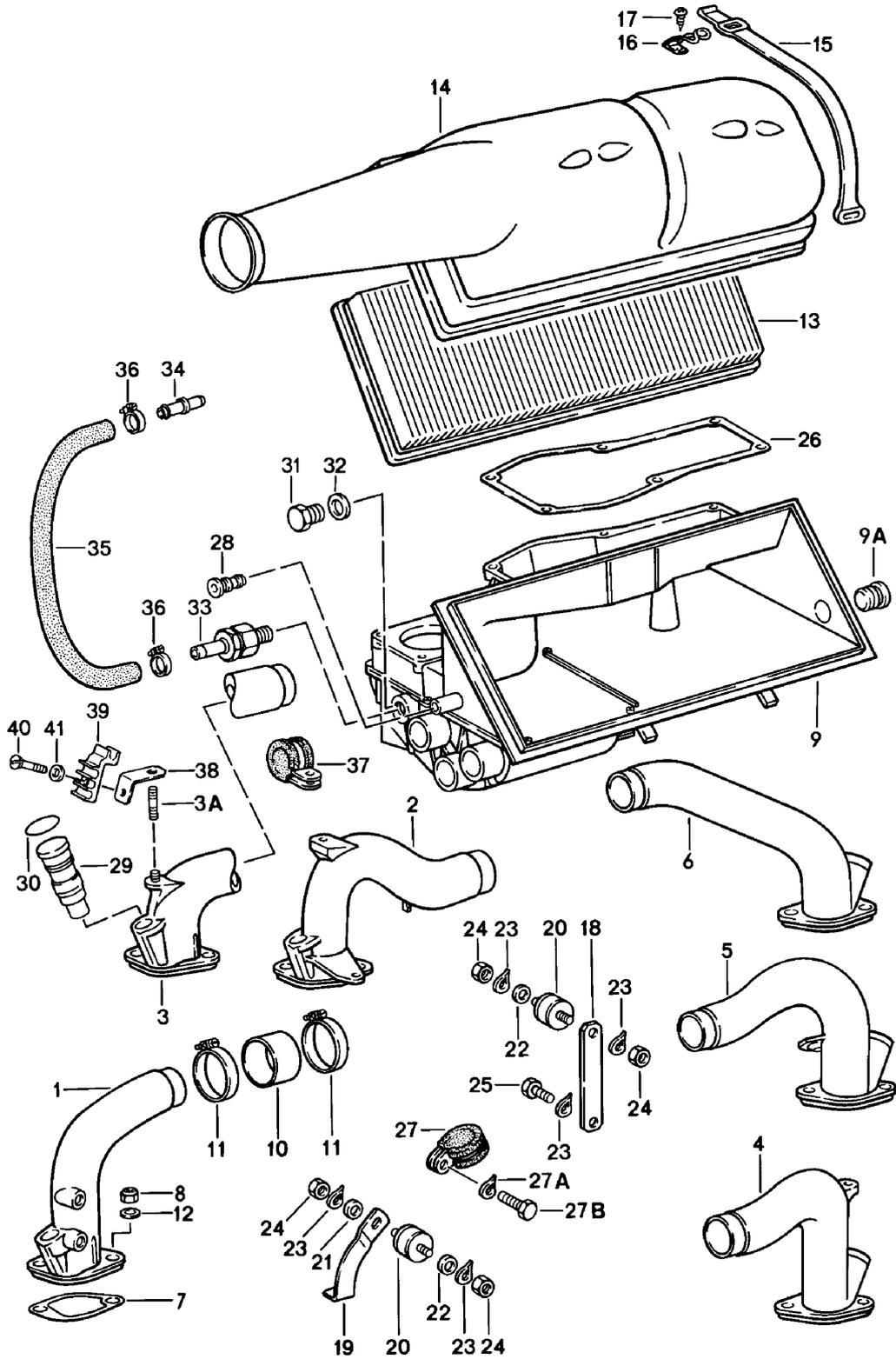

Model: 911 78 Model life 1978>>1983

Pos	Part Number	Description	Remark	Qty	Model
		Air cleaner			911 SC
1	911 110 420 06	Intake pipe Cylinder 1		1	
2	911 110 470 06	Intake pipe Cylinder 2		1	
3	911 110 480 06	Intake pipe Cylinder 3		1	
3A	999 062 006 02	Stud BM 8 X 20		2	
4	911 110 440 06	Intake pipe Cylinder 4		1	
5	911 110 450 06	Intake pipe Cylinder 5		1	
6	911 110 490 06	Intake pipe Cylinder 6	-79	1	
6	911 110 420 06	Intake pipe Cylinder 6	80-	1	
7	930 110 197 12	Gasket		6	
8	999 084 601 02	Lock nut M 8		12	
8	999 084 601 0C	Lock nut M 8		12	
9	911 110 106 13	Housing	-80	1	
9	911 110 906 00	Housing		1	
(9)	911 110 106 20	Housing Use also: 900.123.118.30 900.124.020.01		1	
9	911 110 106 19	Housing	81-	1	
9	911 110 906 00	Housing		1	
(9)	911 110 106 20	Housing Use also: 900.123.118.30 900.124.020.01		1	
9A	930 110 299 00	Stopper		1	
10	928 110 158 01	Rubber sleeve		6	
11	999 512 230 02	Hose clamp S 51/9		12	
12	900 025 007 02	Washer		12	
12	900 025 007 03	Washer		12	
12	900 025 007 02	Washer A 8,4		12	
12	900 025 007 03	Washer A 8,4		12	
13	911 110 185 02	Filter element		1	
14	930 110 184 00	Lid		1	
15	930 110 365 00	Restraining strap		2	
16	911 110 356 01	Support		2	
17	900 143 126 02	Tapping screw		2	
17	900 143 126 0C	Tapping screw		2	
18	911 110 133 02	Strut		1	
19	911 110 269 00	Strut	-80	1	
19	911 110 132 00	Strut	81-	1	
20	911 110 154 00	Bonded rubber buffer		2	
21	900 025 007 02	Washer A 8,4		1	
21	900 025 007 03	Washer A 8,4		1	
22	900 151 008 02	Washer B 8,4		2	
23	N 012 241 8	Spring washer B 8		5	
24	900 076 025 02	Hexagon nut		4	

Model: 911 78

Model life 1978>>1983

Pos	Part Number	Description	Remark	Qty	Model
24	900 076 064 02	M 8 Hexagon nut		4	
25	N 010 239 11	M 8 Hexagon-head bolt		1	
25	N 010 239 30	Hexagon-head bolt		1	
	N 010 239 11	Hexagon-head bolt		1	
		M 8 X 18			
	N 010 239 30	Hexagon-head bolt		1	
		M 8 X 18			
26	911 110 394 02	Gasket		1	
27	999 511 111 02	Pipe clamp	80-	1	
27A	N 012 226 5	Spring washer	80-	1	
27A		Spring washer		1	
		B 6			
27B	999 072 005 09	Hexagon nut	80-	1	
		M 6 X 12			
27B	999 072 005 01	Hexagon nut	80-	1	
		M 6 X 12			
28	911 108 291 00	Stopper		1	
29	911 110 886 03	O-ring		6	
30	999 701 446 40	O-ring		6	
31	900 124 002 02	Screw plug		1	
		AM 14 X 1,5			
32	900 123 007 70	Sealing ring		1	
		A 14-18			
33	911 125 341 01	Union	/LL SPM	1	
33	911 125 341 02	Union	/LL	1	
		M >> 640 2869			
		M >> 630 8274			
33	930 110 357 00	Union	80-	1	
		M 640 2870 >>			
		M 630 8275 >>			
33	905 116 725 00	Check valve	/RL	1	
34	930 110 267 00	Hose connection	/LL	1	
-	999 239 018 40	Hose		*	
-	999 181 022 51	Hose		*	
		12 X 19			
35		220 MM	-79	1	
35		110 MM	80-	1	
36	999 512 554 00	Hose clamp	/LL	2	
37	999 511 115 02	Pipe clamp	80	1	
38	930 110 374 01	Retaining bracket	81-	1	
39	930 110 361 00	Support	81-	1	
40	N 014 117 9	Oval-head screw	81-	1	
		M 4 X 15			
41	N 011 522 14	Washer	81-	1	
		A 4,3			

Model: 911 78

Model life 1978>>1983

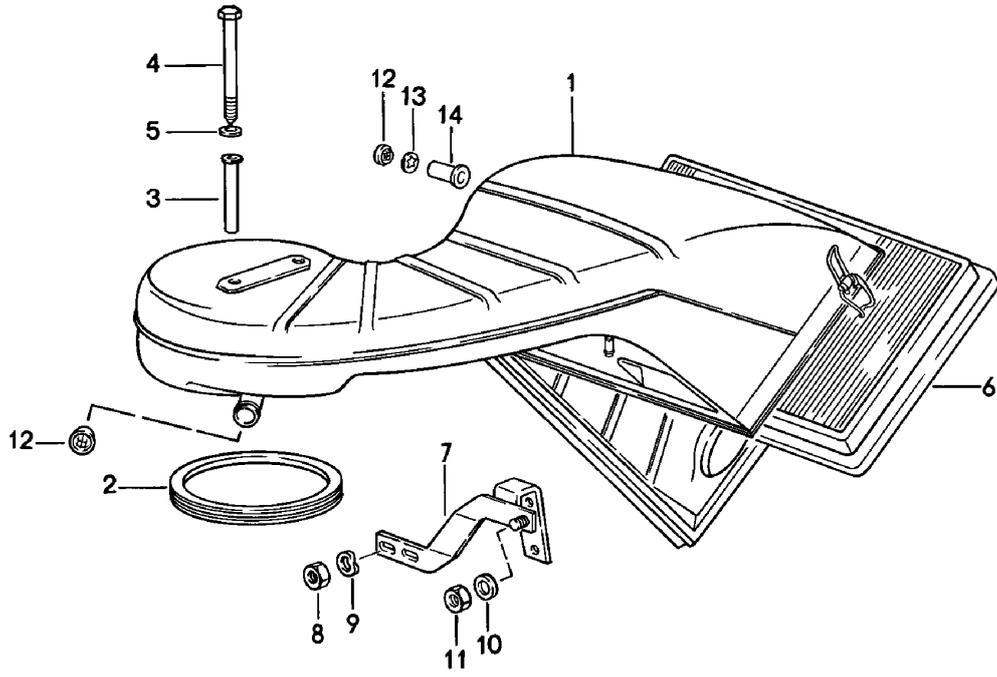

Model: 911 78

Model life 1978>>1983

Pos	Part Number	Description	Remark	Qty	Model
		Air cleaner			TURBO
1	930 110 020 01	Air cleaner		1	
2	930 110 122 00	Sealing ring		1	
-	930 110 121 02	Support ring		1	
3	930 110 436 01	Spacer sleeve		2	
4	900 074 023 02	Hexagon-head bolt		2	
5	N 011 524 7	Washer		2	
5	N 011 524 27	Washer		2	
5	N 011 524 7	Washer		2	
		6,4			
5	N 011 524 27	Washer		2	
		6,4			
6	930 110 185 02	Air cleaner cartridge		1	
7	930 110 331 03	Support		1	
7		Support		1	
8	999 084 423 02	Lock nut		1	
9	900 025 007 02	Washer		2	
9	900 025 007 03	Washer		2	
9	900 025 007 02	Washer		2	
		8,4			
9	900 025 007 03	Washer		2	
		8,4			
10	N 012 241 8	Spring washer		2	
10		Spring washer		2	
		B 8			
11	900 076 025 02	Hexagon nut		2	
		M 8			
11	900 076 064 02	Hexagon nut		2	
		M 8			
12	930 110 422 01	Strainer		1	M026
		see			
		POS 14			
13	999 591 369 02	Locking washer		1	M026
13	999 591 369 0B	Locking washer		1	M026
14	911 106 415 01	Pipe		1	M026
		with			
		Strainer			
		POS. 12			

Model: 911 78

Model life 1978>>1983

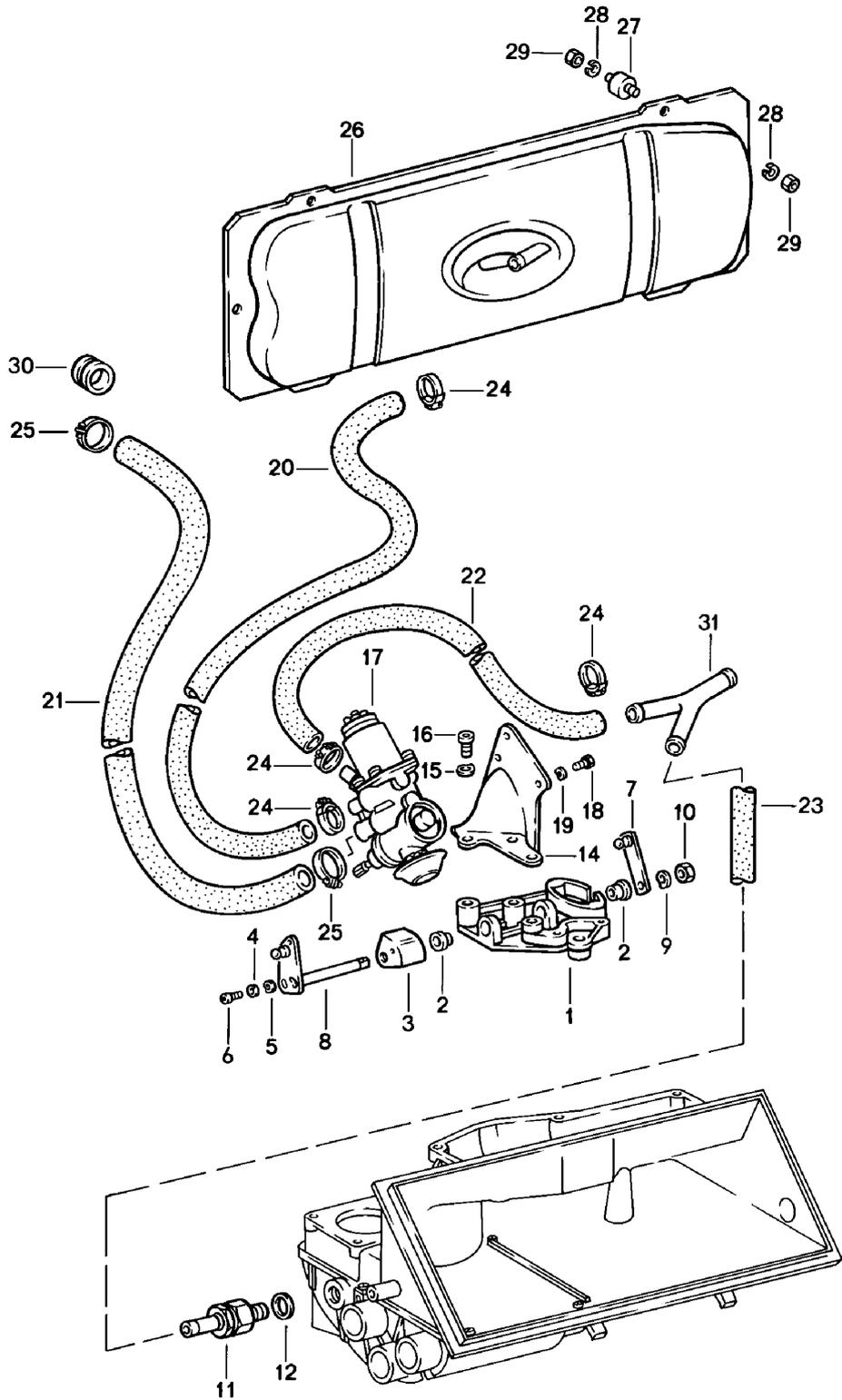

Model: 911 78 Model life 1978>>1983

Pos	Part Number	Description	Remark	Qty	Model
		Supplier -SPM-			
		Vacuum system for Clutch release			
1	911 110 234 00	Bracket		1	
2	901 423 253 00	Bearing sleeve		2	
3	911 125 027 01	Disc cam		1	
4	900 089 011 02	Washer 4		1	
5	N 012 224 3	Spring washer		1	
5		Spring washer B 4		1	
6	900 067 080 02	Pan-head screw M 4 X 10		1	
6	900 067 080 03	Pan-head screw M 4 X 10		1	
7	911 110 110 00	Lever		1	
8	911 110 060 01	Lever		1	
9	N 012 241 8	Spring washer		1	
9		Spring washer B 8		1	
10	900 076 025 02	Hexagon nut M 8		2	
10	900 076 064 02	Hexagon nut M 8		2	
11	905 116 725 00	Check valve	/RL	1	
(11)	911 125 341 01	Union	/LL	1	
12	900 123 007 70	Sealing ring A 14 X 18		1	
14	911 125 331 01	Support		1	
15	N 012 241 8	Spring washer B 8		3	
16	N 014 707 2	Pan-head screw M 8 X 15		3	
16	900 067 131 03	Pan-head screw M 8 X 15		3	
17	905 108 370 02	Control valve		1	
18	999 072 005 09	Hexagon nut M 6 X 12		3	
18	999 072 005 01	Hexagon nut M 6 X 12		3	
19	N 012 226 5	Spring washer B 6		3	
20	911 125 703 00	Vacuum hose 12 X 3,5 550 MM		1	
21	999 181 282 50	Vacuum hose 360 MM		*	
22	911 125 703 02	Vacuum hose	/LL	1	
22	999 181 022 51	Hose 130 MM		*	
23	911 125 703 01	Vacuum hose		1	
23	999 181 022 51	Hose 220 MM		*	
24	999 512 554 00	Hose clamp		4	
25	N 023 565 3	Hose clamp		2	
25		Hose clamp S 21/9 ZY. VERZ.		2	
26	911 116 033 00	Vacuum tank		1	
27	901 504 853 20	Bearing		2	
28	900 027 014 01	Lock ring		8	
28	N 012 006 4	Lock ring		8	

Model: 911 78

Model life 1978>>1983

Pos	Part Number	Description	Remark	Qty	Model
29	900 076 010 02	B 6 Nut		8	
29	900 076 010 0B	M 6 Nut		8	
30	999 702 064 50	M 6 Grommet		1	
31	911 125 342 00	Y-piece	/LL	1	

Model: 911 78

Model life 1978>>1983

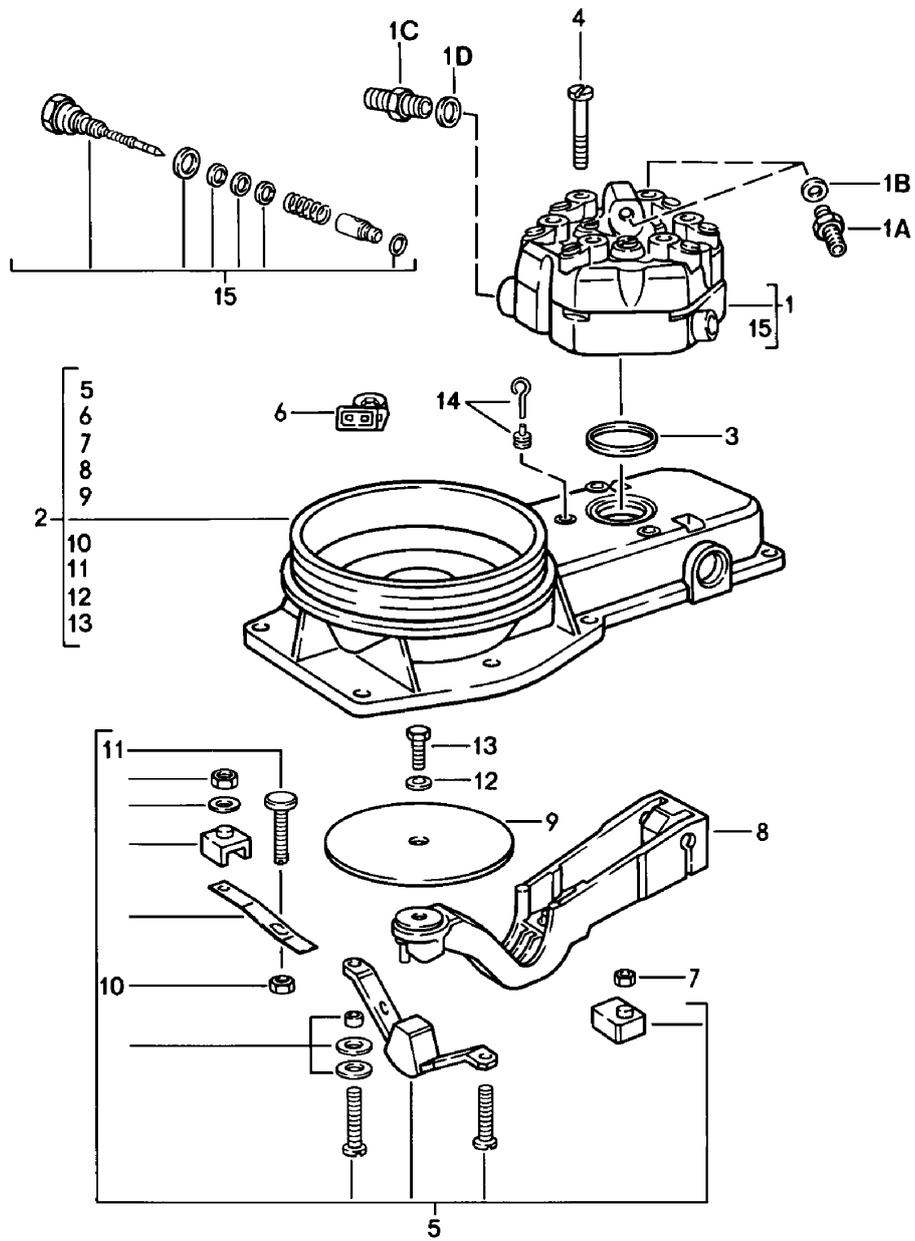

Model: 911 78

Model life 1978>>1983

Pos	Part Number	Description	Remark	Qty	Model
		Mixture control unit			911 SC
1	911 110 967 00	Fuel distributor		1	930.03/09
1	911 110 967 X	Fuel distributor		1	930.03/09
					930.13/19
1	911 110 977 00	Fuel distributor		1	930.10
1	911 110 977 X	Fuel distributor		1	930.10
1A	930 110 629 00	Screw socket	81-	8	
1B	900 123 050 30	Sealing ring	81-	8	
1B	900 123 115 30	Sealing ring	81-	8	
		A 8 X 11,5			
1C	900 283 001 02	Connection piece	81-	2	
1D	900 123 116 30	Sealing ring	81-	2	
		A 12 X 15,5			
2	911 110 965 00	Mass air flow meter		1	930.03/09
					930.13/19
2	911 110 965 X	Mass air flow meter		1	930.03/09
					930.13/19
2	911 110 975 00	Mass air flow meter		1	930.10
2	911 110 975 X	Mass air flow meter		1	930.10
3	911 110 932 00	Sealing ring		1	
4	911 110 933 00	Pan-head screw		3	
		M 5 X 50			
5	911 110 947 02	Stop bar		1	
		Stop bar			
5		Stop bar		1	
		Stop bar			
6	911 110 929 00	Safety contact		1	
7	911 110 945 00	Lock nut		2	
8	911 110 939 00	Control lever		1	
9	911 110 943 00	Air flow sensor plate		1	
10	911 110 950 00	Hexagon nut		1	
11	911 110 949 00	Adjusting screw		1	
12	N 012 226 5	Spring washer		1	
12		Spring washer		1	
		A 6			
13	911 110 944 00	Hexagon-head bolt		1	
14	911 110 934 00	Stopper		1	
15	928 110 920 01	Parts kit		1	
		Pressure regulator			
		See workshop manual			
		KD-NR. 256155			

Model: 911 78

Model life 1978>>1983

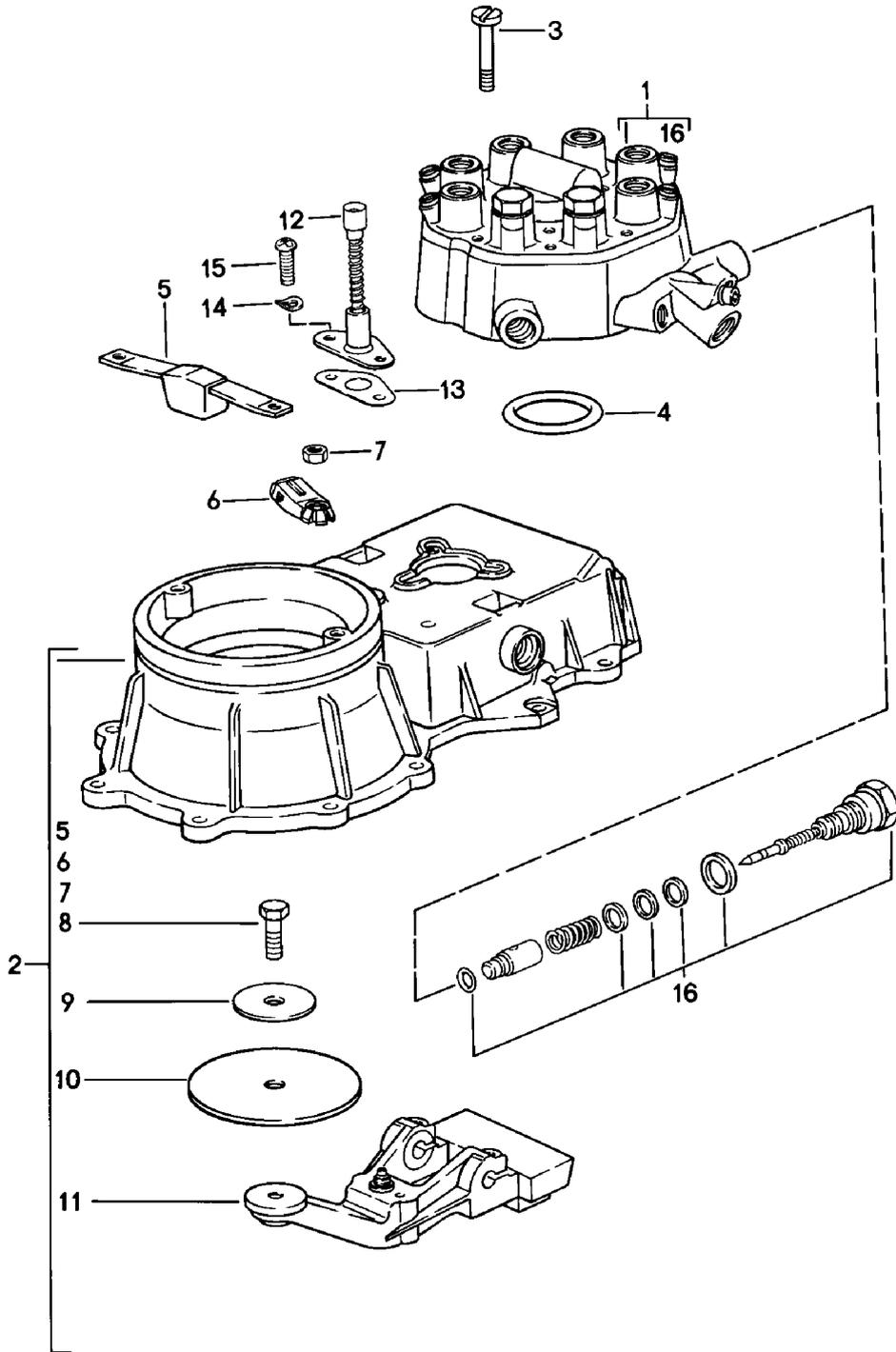

Model: 911 78

Model life 1978>>1983

Pos	Part Number	Description	Remark	Qty	Model
		Mixture control unit			TURBO
1	930 110 909 00	Fuel distributor		1	
2	930 110 907 00	Mass air flow meter		1	
3	900 146 045 02	Oval-head screw AM 5 X 45		3	
4	911 110 936 01	Gasket		1	
5	911 110 961 00	Stop		1	
6	911 110 929 00	Safety contact		1	
7	911 110 945 00	Lock nut		1	
8	911 110 944 01	Hexagon-head bolt		1	
9	911 110 960 00	Support washer		1	
10	911 110 943 01	Air flow sensor plate		1	
10	911 110 943 03	Air flow sensor plate		1	
11	911 110 959 00	Control lever		1	
12	930 110 910 02	Adjusting key		1	
13	930 110 911 00	Gasket		1	
14	N 012 005 3	Lock ring B 5		2	
15	N 014 128 13	Oval-head screw AM 5 X 8		2	
16	928 110 920 01	Parts kit Pressure regulator See workshop manual KD-NR. 256155		1	

Model: 911 78

Model life 1978>>1983

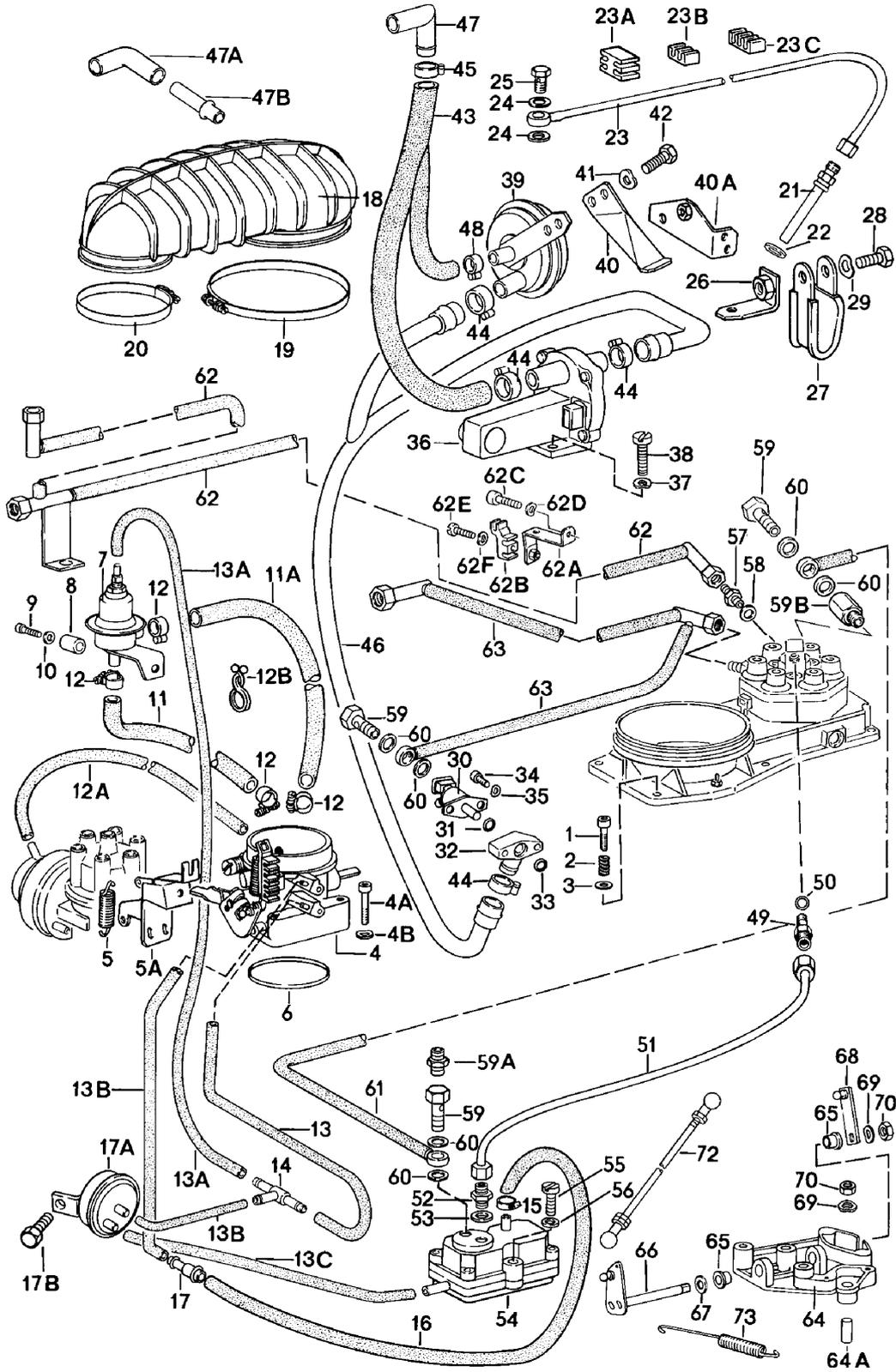

Model: 911 78 Model life 1978>>1983

Pos	Part Number	Description	Remark	Qty	Model
		K-jetronic			911 SC 930.03/04 930.05/06 930.09/10 930.13/15 930.19
1	900 067 089 02	Pan-head screw M 6 X 25		6	
1	900 067 089 01	Pan-head screw M 6 X 25		6	
2	911 110 364 00	Compression spring		6	
3	900 031 011 02	Washer 6,4		6	
4	930 110 248 01	Flap-Nozzle 63 \$	-79	1	
4		Flap-Nozzle 63 \$	(D) -78	1	
4	930 110 248 02	Flap-Nozzle 63 \$	-80	1	
4		Flap-Nozzle 63 \$	(D) 79-80	1	
4	930 110 248 11	Flap-Nozzle 63 \$	81-	1	
4		Flap-Nozzle 63 \$	81-	1	
-	930 110 292 00	Stopper	-80	1	
4A	900 067 013 02	Pan-head screw M 6 X 35		4	
4B	N 011 524 7	Washer		4	
4B	N 011 524 27	Washer		4	
5	930 110 497 00	Tension spring		1	
5A	911 110 918 01	Support for Flap-Nozzle	-80	1	
5A	911 110 918 02	Support for Flap-Nozzle	81-	1	
5A	911 110 918 03	Support for Flap-Nozzle 930 110 248 04	81-	1	
6	999 701 124 40	O-ring 67,5 X 4		1	
7	911 110 220 00	Vacuum limiter		1	
8	911 110 591 00	Spacer sleeve		1	
9	N 010 220 3	Hexagon-head bolt M 6 X 28		1	
10	N 012 226 5	Spring washer B 6		1	
-	N 020 359 1	Hose 9 X 2,5		*	
11		190 MM		1	
11A		110 MM		1	
12	N 023 577 2	Hose clamp A 9 X 14		4	
12	PCG 023 577 2	Hose clamp		1	
-	999 239 020 40	Hose 3,2 X 7	80-	*	
12A		Red 930 MM		1	
12B	999 651 154 40	Cable tie	81-	1	
-	N 020 353 5	Hose		*	

Model: 911 78 Model life 1978>>1983

Pos	Part Number	Description	Remark	Qty	Model
13	PCG 020 353 5	3,5 X 2 Hose		X	
13		3,5 X 2 X 5000		1	
13A		245 MM		1	
13B		30 MM		2	
13C		370 MM		1	
14	999 137 004 40	330 MM		1	
15	N 023 577 2	T-piece		1	
15	PCG 023 577 2	Hose clamp		1	
-	999 181 709 50	A 9 X 14		*	
16		Hose clamp		1	
17	930 110 273 02	Hose		1	
-	930 110 292 00	8 X 14		1	
17A	911 606 106 01	40 MM		1	
17A		Reducing socket	78	1	
17B	999 072 005 09	Stopper	79-	1	
17B	999 072 005 01	Hexagon nut		1	
18	930 110 358 05	M 6 X 12		1	
19	999 512 303 02	Hexagon nut		1	
20	999 512 302 02	Air guide		1	
20	PCG 512 302 02	Hose clamp		1	
21	911 110 225 01	S 131/9		1	
22	999 701 423 40	Hose clamp		1	
23	911 110 093 11	S 85/9		6	
23	911 110 093 12	Injector valve		6	
(23)	930 110 485 00	O-ring		3	
(23)	930 110 486 00	Injection line	-80	3	
(23)	930 110 487 00	Cylinder 1			
(23)	930 110 488 00	Cylinder 2			
(23)	930 110 489 02	Cylinder 3			
(23)	930 110 490 00	Injection line	-80	3	
23A	928 110 149 00	Cylinder 4			
23B	928 110 150 00	Cylinder 5			
23C	928 110 150 01	Cylinder 6			
24	900 123 115 30	Injection line	81-	1	
25	911 110 899 00	Injection line	81-	1	
26	911 110 238 00	Injection line	81-	1	
27	999 511 097 02	Injection line	81-	1	
28	999 072 005 09	Zylinder 5Einspritzleit	81-	1	
		Injection line			
		Zylinder 5 1			
		Injection line			
		Zyl. 410313			
		Injection line			
		Zyl. 610315			
		Terminal	81-	2	
		Terminal	81-	3	
		Terminal	81-	1	
		Sealing ring		8	
		A 8 X 11,5EinspritzlZyl			
		Banjo bolt		6	
		Bracket	-80	1	
		Pipe clamp		1	
		Hexagon nut		1	
		M 6 X 12			

Model: 911 78 Model life 1978>>1983

Pos	Part Number	Description	Remark	Qty	Model
28	999 072 005 01	Hexagon nut M 6 X 12		1	
29	N 012 226 5	Spring washer B 6		1	
30	911 606 107 01	Start valve		1	
31	999 701 395 50	O-ring 7-2 B		1	
32	911 110 264 00	Intermediate piece		1	
33	999 701 210 40	O-ring OR 20-2,5		1	
33	999 701 210 4A	O-ring OR 20-2,5		1	
34	900 067 150 02	Pan-head screw M 5 X 32		2	
35	900 028 007 02	Spring washer		2	
35	N 012 222 4	Spring washer B 5		2	
36	911 606 102 01	Auxiliary air regulator	-82	1	
36	911 606 102 AX	Auxiliary air regulator		1	
36	911 606 102 10	Auxiliary air regulator	83-	1	930.10
36	911 606 102 IX	Auxiliary air regulator	83-	1	930.10
36	911 606 102 10	Auxiliary air regulator	83-	1	930.10
36	911 606 102 IX	Auxiliary air regulator	83-	1	930.10
37	N 012 226 5	Spring washer		2	
37		Spring washer A 6		2	
38	N 014 740 2	Pan-head screw		2	
38	N 014 740 11	Pan-head screw		2	
36	N 014 740 2	Pan-head screw M 6 X 16		2	
36	N 014 740 11	Pan-head screw M 6 X 16		2	
39	911 110 273 00	Additional air valve	-80	1	
39	911 110 273 X	Additional air valve		1	
39	911 110 273 01	Additional air valve	81-	1	
39	911 110 273 AX	Additional air valve	81-	1	
40	911 110 274 01	Support		1	
40A	930 110 355 01	Retaining bracket	80-	1	
41	N 012 226 5	Spring washer B 6		2	
42	N 010 210 13	Hexagon-head bolt M 6 X 10		2	
43	911 110 276 02	Hose line		1	
44	N 024 162 1	Hose clamp S 25/9		4	
45	N 024 141 2	Hose clamp 9 X 31 ZY		2	
46	911 110 277 01	Pipeline		1	
47	911 110 286 00	Connecting pipe		1	
47A	930 107 286 00	Connecting pipe	-81	1	
47B	901 107 729 00	Backfire grid	-81	1	
48	999 512 045 02	Hose clamp S 22/9		1	
49	911 110 160 01	Screw socket	-80	1	
50	900 123 050 30	Sealing ring		1	
50	900 123 115 30	Sealing ring		1	
51	930 110 502 00	Fuel line	-80	1	
(51)	930 110 494 00	Fuel line	81-	1	
(51)	930 110 494 01	Fuel line	81-	1	
52	900 915 004 02	Connection piece		1	
53	900 123 144 30	Sealing ring A 10 X 13,5		1	
54	911 606 105 09	Warm-up valve	78	1	

Model: 911 78

Model life 1978>>1983

Pos	Part Number	Description	Remark	Qty	Model
54	911 606 105 JX	Warm-up valve	78	1	
54	911 606 105 09	Warm-up valve	80	1	
54	911 606 105 JX	Warm-up valve	80	1	
54	911 606 105 09	Warm-up valve		1	
54	911 606 105 JX	Warm-up valve		1	
55	N 044 703 3	Pan-head screw		2	
55		Pan-head screw M 6 X 45		2	
56	N 012 226 5	Spring washer		2	
56		Spring washer A 6		2	
57	N 020 704 2	Connection piece		2	
57		Connection piece		2	
58	900 123 116 30	Sealing ring A 12 X 15,5		2	
59	911 110 899 00	Banjo bolt	-80	3	
59A	930 110 629 00	Screw socket	81-	1	
59B	930 110 429 00	Screw socket	-80	1	
60	900 123 115 30	Sealing ring A 8 X 11,5		6	
61	930 110 513 00	Fuel line	-80	1	
(61)	930 110 495 00	Fuel line	81-	1	
62	930 110 514 00	Fuel line	-80	1	
(62)	930 110 498 00	Fuel line	81-	1	
62A	930 110 374 00	Retaining bracket	81-	1	
62B	930 110 361 00	Support	81-	1	
62C	900 075 057 02	Hexagon-head bolt M 6 X 16	81-	1	
62C	900 075 057 03	Hexagon-head bolt M 6 X 16	81-	1	
62D	N 012 226 5	Spring washer B 6	81-	1	
62E	N 014 117 9	Oval-head screw M 4 X 15	81-	1	
62F	N 011 522 14	Washer A 4,3	81-	1	
63	930 110 570 00	Fuel line	-80	1	
(63)	930 110 491 00	Fuel line	81-	1	
64	911 110 234 00	Bracket		1	
64A	901 110 236 00	Spacer tube		1	
65	901 423 253 00	Bearing sleeve		2	
66	911 110 060 01	Lever		1	
67	900 031 001 02	Washer		1	
67	900 031 105 01	Washer		1	
67	900 025 007 02	Washer 8,4		1	
67	900 025 007 03	Washer 8,4		1	
68	911 110 110 00	Lever		1	
69	N 012 241 8	Spring washer		4	
70	900 076 025 02	Hexagon nut		4	
70	900 076 064 02	Hexagon nut		4	
72	911 110 077 03	Pull rod		1	
72	911 110 077 01	Pull rod		1	
73	911 110 165 02	Tension spring		1	

Model: 911 78

Model life 1978>>1983

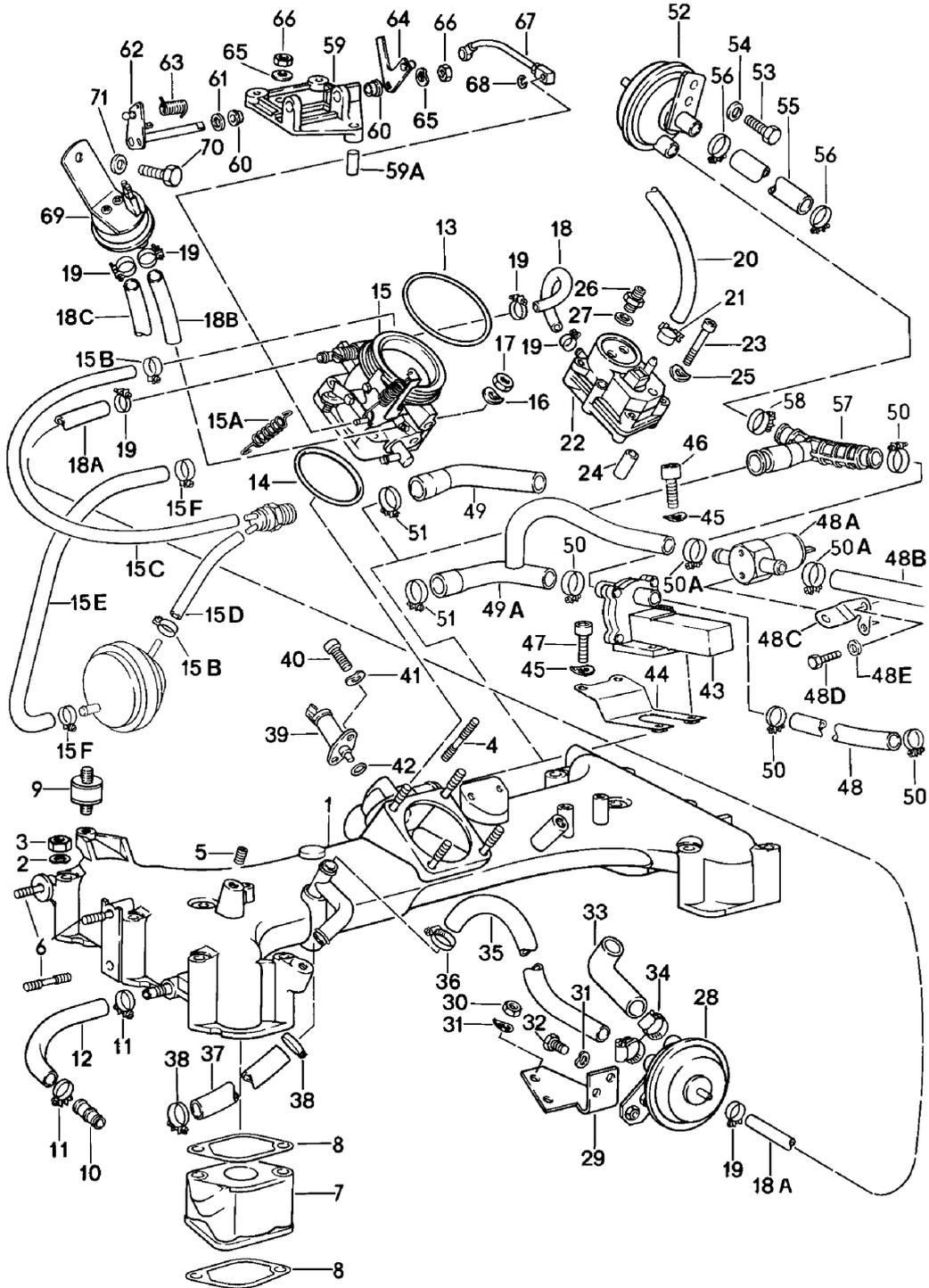

Model: 911 78 Model life 1978>>1983

Pos	Part Number	Description	Remark	Qty	Model
		K-jetronic I			TURBO 930.60/61 930.62/66
1	930 110 034 00	Intake manifold		1	
2	N 012 241 8	Spring washer B 8		12	
3	900 076 025 02	Hexagon nut M 8		12	
3	900 076 064 02	Hexagon nut M 8		12	
4	999 062 093 02	Stud BM 6 X 35		4	
5	999 504 004 00	Threaded insert M 8		3	
6	999 062 009 02	Stud		3	
6	900 060 105 01	Stud		3	
6	999 062 009 02	Stud BM 8 X 28		3	
6	900 060 105 01	Stud BM 8 X 28		3	
7	930 110 141 03	Flange		6	
8	930 110 197 10	Gasket		12	
9	930 110 194 00	Bonded rubber buffer		3	
9	999 703 263 00	Bonded rubber buffer		3	
10	930 110 267 00	Hose connection		1	
11	999 512 554 00	Hose clamp		2	
-	999 239 011 40	Hose 12 X 19 270 MM		*	
12				1	
13	999 701 477 40	Round seal		1	
14	999 701 468 40	Round seal		1	
15	930 110 250 03	Flap-Nozzle		1	930.60
15	930 110 250 08	Flap-Nozzle		1	930.66
15A	930 110 497 00	Tension spring		1	
15B	999 512 361 02	Hose clamp		2	930.66
-	999 239 020 40	Hose Red 3,2 X 7		*	930.66
15C		390 MM		1	930.66
15D		1000 MM		1	930.66
-	999 239 022 40	Hose Blue 4 X 10 575 MM		*	930.66
15E				1	930.66
15F	999 512 159 02	Hose clamp		2	930.66
16	N 011 524 7	Washer		4	
16	N 011 524 27	Washer		4	
17	900 076 010 02	Nut M 6		4	
17	900 076 010 0B	Nut M 6		4	
-	999 239 013 40	Hose 5 X 11		*	
-	999 239 013 4A	Hose 5 X 11		*	
18		150 MM		1	
18A		405 MM		1	
-		500 MM		1	
19	999 512 082 02	Hose clamp		12	
19	999 512 082 01	Hose clamp		12	
-	999 239 006 40	Hose 8 X 14		*	

Model: 911 78

Model life 1978>>1983

Pos	Part Number	Description	Remark	Qty	Model
-	999 239 034 40	Hose 7,3 X 3		*	
20		100 MM		1	
21	999 512 160 02	Hose clamp		4	
21	PCG 512 160 02	Hose clamp		4	
22	930 606 105 03	Warm-up valve		1	930.60/61
22	930 606 105 CX	Warm-up valve		1	930.60/61
22	930 606 105 05	Warm-up valve		1	930.62/66
22	930 606 105 EX	Warm-up valve		1	930.62/66
23	N 044 703 3	Pan-head screw M 6 X 45		2	
23	900 119 055 02	Pan-head screw M 6 X 60		2	
24	911 110 591 00	Spacer sleeve	-80	2	
25	N 012 226 5	Spring washer A 6		2	
26	900 915 004 02	Connection piece		1	
27	900 123 144 30	Sealing ring A 10 X 13,5		1	
28	930 110 173 00	Vacuum limiter		1	
29	930 110 167 00	Retaining bracket		1	
30	900 076 010 02	Nut M 6		2	
30	900 076 010 0B	Nut M 6		2	
31	N 012 226 5	Spring washer B 6		4	
32	999 072 005 09	Hexagon nut M 6 X 12		2	
32	999 072 005 01	Hexagon nut M 6 X 12		2	
33	930 110 171 01	Hose		1	
34	PCG 512 237 02	Hose clamp		2	
-	999 239 007 40	Hose 15 X 24		*	
35		90 MM		1	
36	N 024 115 1	Hose clamp		2	
-	999 181 284 50	Hose 15 X 3,5		*	
37		300 MM		1	
38	999 512 045 02	Hose clamp		2	
39	930 606 107 01	Electric starting valve		1	
40	N 014 740 2	Pan-head screw M 6 X 16		2	
40	N 014 740 11	Pan-head screw M 6 X 16		2	
41	N 012 226 5	Spring washer A 6		2	
42	999 701 395 50	O-ring		1	
43	930 606 102 00	Auxiliary air regulator		1	
43	930 606 102 X	Auxiliary air regulator		1	
44	930 110 229 01	Support		1	
45	N 012 226 5	Spring washer B 6		4	
46	999 062 009 02	Stud M 6 X 15		2	
46	900 060 105 01	Stud M 6 X 15		2	
47	900 067 008 02	Pan-head screw M 6 X 12		2	
47	900 067 008 03	Pan-head screw M 6 X 12		2	
48	999 239 009 40	Hose		*	

Model: 911 78

Model life 1978>>1983

Pos	Part Number	Description	Remark	Qty	Model
48		Hose 18 X 26 X 180		*	
48A	928 606 215 01	Electric air valve		1	930.66
48B	930 110 403 01	Hose		1	930.66
48C	930 110 623 00	Retaining bracket		1	930.66
48D	N 010 208 5	Hexagon-head bolt M6X8		1	930.66
48E	N 011 524 7	Washer A 6,4		1	930.66
48E	N 011 524 27	Washer A 6,4		1	930.66
49	930 110 335 00	Air hose	-82	1	
49	930 110 335 08	Air hose		1	
49A	930 110 335 01	Air hose		1	930.66
49A	930 110 335 09	Air hose		1	930.66
50	999 512 552 00	Hose clamp		3	
50	999 512 552 01	Hose clamp		3	
50A	999 512 198 02	Hose clamp		2	930.66
50A	PCG 512 198 02	Hose clamp		2	930.66
50A	N 023 570 2	Hose clamp		2	930.66
51	N 024 141 2	Hose clamp		1	
59	930 110 061 02	Bracket		1	
59	911 110 091 07	Bracket		1	
59A	901 110 236 00	Spacer tube		1	
60	901 423 253 00	Bearing sleeve		2	
-	999 504 008 00	Threaded insert M 6		2	
61	900 025 007 02	Washer 8,4		2	
61	900 025 007 03	Washer 8,4		2	
62	930 110 060 02	Lever		1	
63	930 110 148 01	Steering knuckle spring		1	
64	930 110 110 02	Lever		1	
64	930 110 110 06	Lever		1	
		Use also:			
62	930 110 060 06	Lever		1	
63	930 110 148 05	Steering knuckle spring		1	
65	N 012 241 8	Spring washer B 8		4	
66	900 076 025 02	Hexagon nut M 8		4	
66	900 076 064 02	Hexagon nut M 8		4	
67	930 110 079 04	Pull rod		1	
67	930 110 079 05	Pull rod		1	
68	N 012 434 1	Lock washer		1	
68	900 116 003 02	Lock washer		1	
68	900 116 003 09	Lock washer		1	

Model: 911 78

Model life 1978>>1983

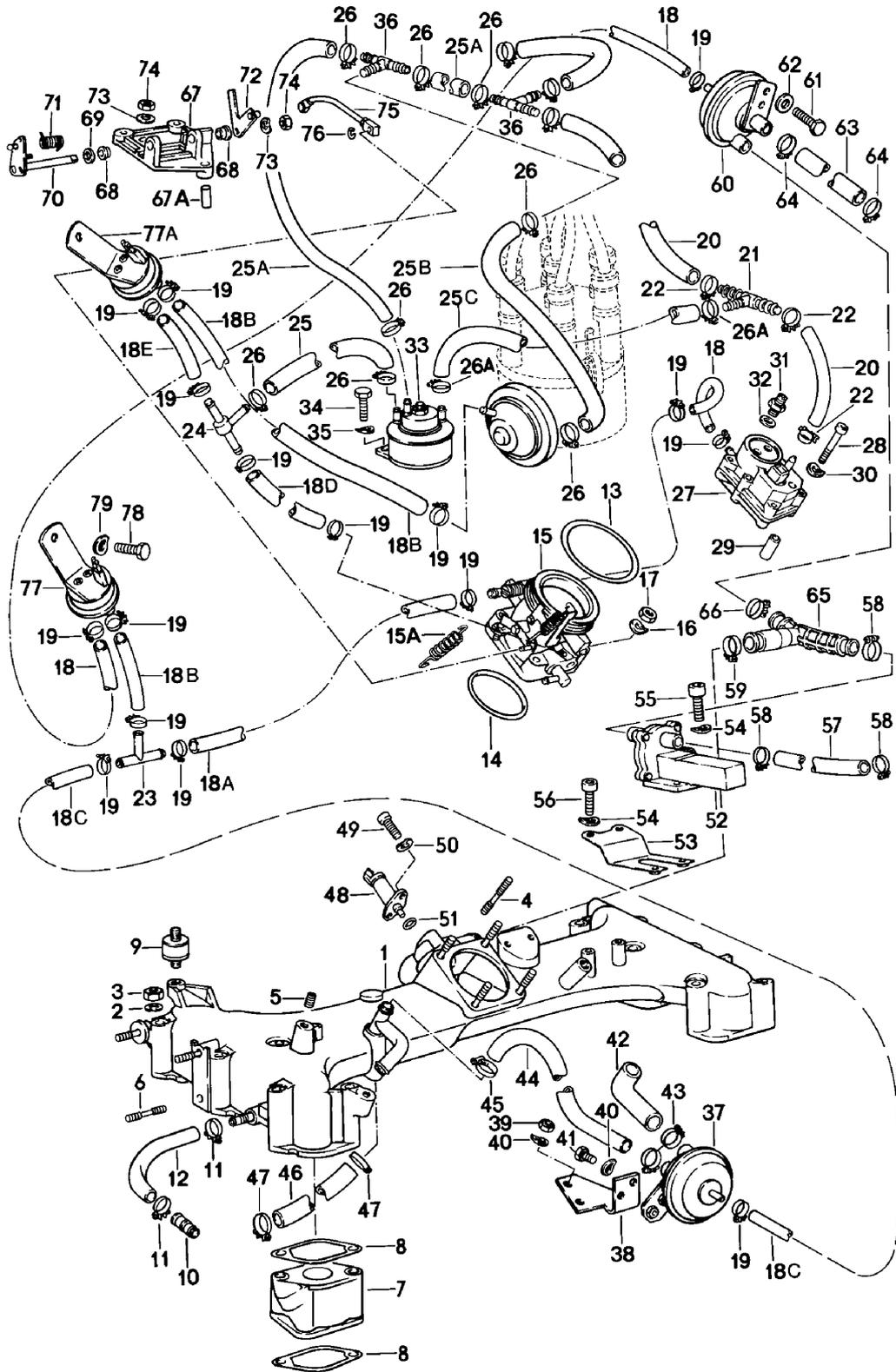

Model: 911 78

Model life 1978>>1983

Pos	Part Number	Description	Remark	Qty	Model
		K-jetronic I			TURBO 930.63/64 930.65
1	930 110 034 01	Intake manifold		1	
2	N 012 241 8	Spring washer B 8		12	
3	900 076 025 02	Hexagon nut M 8		12	
3	900 076 064 02	Hexagon nut M 8		12	
4	999 062 093 02	Stud BM 6 X 35		4	
5	999 504 004 00	Threaded insert M 8		3	
6	999 062 009 02	Stud BM 8 X 28		3	
6	900 060 105 01	Stud BM 8 X 28		3	
7	930 110 141 03	Flange		6	
8	930 110 197 10	Gasket		12	
9	930 110 194 00	Bonded rubber buffer		3	
9	999 703 263 00	Bonded rubber buffer		3	
10	930 110 267 00	Hose connection		1	
11	999 512 554 00	Hose clamp		2	
-	999 239 011 40	Hose 12 X 19 270 MM		*	
12				1	
13	999 701 477 40	Round seal		1	
14	999 701 468 40	Round seal		1	
15	930 110 250 07	Flap-Nozzle		1	
15A	930 110 497 00	Tension spring		1	
16	N 012 226 5	Spring washer B 6		4	
17	900 076 010 02	Nut M 6		4	
17	900 076 010 0B	Nut M 6		4	
-	999 239 013 40	Hose 5 X 11		*	
-	999 239 013 4A	Hose 5 X 11		*	
18		150 MM		2	930.63
18A		275 MM		1	930.63
18B		400 MM		2	930.63
18C		350 MM		1	930.63
(18C)		405 MM		1	930.64/65
18D		175 MM		1	
18E		85 MM		1	
19	999 512 082 02	Hose clamp		16	
19	999 512 082 01	Hose clamp		16	
-	999 239 006 40	Hose 8 X 14		*	
-	999 239 034 40	Hose 7,3 X 3		*	
20		45 MM		2	
21	999 137 015 40	Reducing t-union		1	
22	999 512 160 02	Hose clamp		4	
22	PCG 512 160 02	Hose clamp		4	
23	999 137 005 40	T-piece		1	930.63
24	930 110 271 01	T-piece		1	
-	000 043 204 94	Hose 4 X 10		*	
25		320 MM		1	

Model: 911 78 Model life 1978>>1983

Pos	Part Number	Description	Remark	Qty	Model
25A		75 MM		2	
25B		460 MM		1	
25C		520 MM		1	
26	999 512 309 02	Hose clamp		10	
26A	999 512 069 02	Hose clamp		2	
26A	PCG 512 069 02	Hose clamp		2	
-	N 020 902 1	Tie-wrap		2	
-	N 020 902 A	Tie-wrap		2	
-	N 020 902 1	Tie-wrap		2	
-	N 020 902 A	Tie-wrap		2	
27	930 606 105 03	Warm-up valve		1	
27	930 606 105 CX	Warm-up valve		1	
28	N 044 703 3	Pan-head screw		2	
28		Pan-head screw M 6 X 45		2	
28	900 119 055 02	Pan-head screw M 6 X 60		2	
29	911 110 591 00	Spacer sleeve		2	
30	N 012 226 5	Spring washer		2	
31	900 915 004 02	Connection piece		1	
32	900 123 003 30	Sealing ring		1	
32	900 123 144 30	Sealing ring A 10 X 14		1	
33	930 113 197 00	Shut-off valve		1	
34	900 075 010 02	Hexagon nut		2	
34	999 072 005 09	Hexagon nut M 6 X 10		2	
34	999 072 005 01	Hexagon nut M 6 X 10		2	
35	N 012 226 5	Spring washer B 6		2	
36	999 137 004 40	T-piece		2	
37	930 110 173 00	Vacuum limiter		1	
38	930 110 167 00	Retaining bracket		1	
39	900 076 010 02	Nut M 6		2	
39	900 076 010 0B	Nut M 6		2	
40	N 012 226 5	Spring washer B 6		4	
41	999 072 005 09	Hexagon nut M 6 X 12		2	
41	999 072 005 01	Hexagon nut M 6 X 12		2	
42	930 110 171 01	Hose		1	
43	PCG 512 237 02	Hose clamp		2	
-	999 239 007 40	Hose 15 X 24		*	
44		90 MM		1	
45	N 024 115 1	Hose clamp		2	
-	999 181 284 50	Hose 15 X 3,5		*	
46		300 MM		1	
47	999 512 045 02	Hose clamp		2	
48	930 606 107 01	Electric starting valve		1	
49	N 014 740 2	Pan-head screw M 6 X 16		2	
49	N 014 740 11	Pan-head screw M 6 X 16		2	
50	N 012 226 5	Spring washer A 6		2	
51	999 701 395 50	O-ring		1	
52	930 606 102 03	Auxiliary air regulator		1	

Model: 911 78

Model life 1978>>1983

Pos	Part Number	Description	Remark	Qty	Model
53	930 110 229 01	Support		1	
54	N 012 226 5	Spring washer B 6		4	
55	900 067 009 02	Pan-head screw		2	
55	900 067 429 01	Pan-head screw		2	
55	900 067 009 02	Pan-head screw M 6 X 15		2	
55	900 067 429 01	Pan-head screw M 6 X 15		2	
56	900 067 008 02	Pan-head screw		2	
56	900 067 008 03	Pan-head screw		2	
56	900 067 008 02	Pan-head screw M 6 X 12		2	
56	900 067 008 03	Pan-head screw M 6 X 12		2	
57	999 239 009 40	Hose		*	
57		Hose 18 X 26 X 180		*	
58	N 024 162 1	Hose clamp		3	
59	N 024 141 2	Hose clamp		1	
60	930 110 275 01	Additional air valve		1	
60	930 110 275 AX	Additional air valve		1	
61	999 072 005 09	Hexagon nut M 6 X 12		2	
61	999 072 005 01	Hexagon nut M 6 X 12		2	
62	N 012 226 5	Spring washer B 6		2	
-	999 239 007 40	Hose 15 X 24 300 MM		*	
63				1	
64	999 512 045 02	Hose clamp		2	
65	930 110 333 00	Air hose		1	
66	N 024 162 1	Hose clamp		1	
67	930 110 061 02	Bracket		1	
67	911 110 091 07	Bracket		1	
67A	901 110 236 00	Spacer tube		1	
68	901 423 253 00	Bearing sleeve		2	
-	999 504 008 00	Threaded insert M 6		2	
69	900 025 007 02	Washer 8,4		2	
69	900 025 007 03	Washer 8,4		2	
70	930 110 060 02	Lever		1	
71	930 110 148 01	Steering knuckle spring		1	
72	930 110 110 03	Lever		1	
73	N 012 241 8	Spring washer B 8		4	
74	900 076 025 02	Hexagon nut M 8		4	
74	900 076 064 02	Hexagon nut M 8		4	
75	930 110 079 04	Pull rod		1	
75	930 110 079 05	Pull rod		1	
76	N 012 434 1	Lock washer		1	
76	900 116 003 02	Lock washer		1	
76	900 116 003 09	Lock washer		1	
77	930 606 106 00	Thermo valve	-78	1	930.63
77	911 606 106 01	Thermo valve	79-	1	930.63
77A		Thermo valve Valve housing		1	
78	900 067 008 02	Pan-head screw		1	930.63

Model: 911 78

Model life 1978>>1983

Pos	Part Number	Description	Remark	Qty	Model
78	900 067 008 03	M 6 X 12 Pan-head screw		1	930.63
79	N 012 226 5	M 6 X 12 Spring washer B 6		1	930.63

Model: 911 78

Model life 1978>>1983

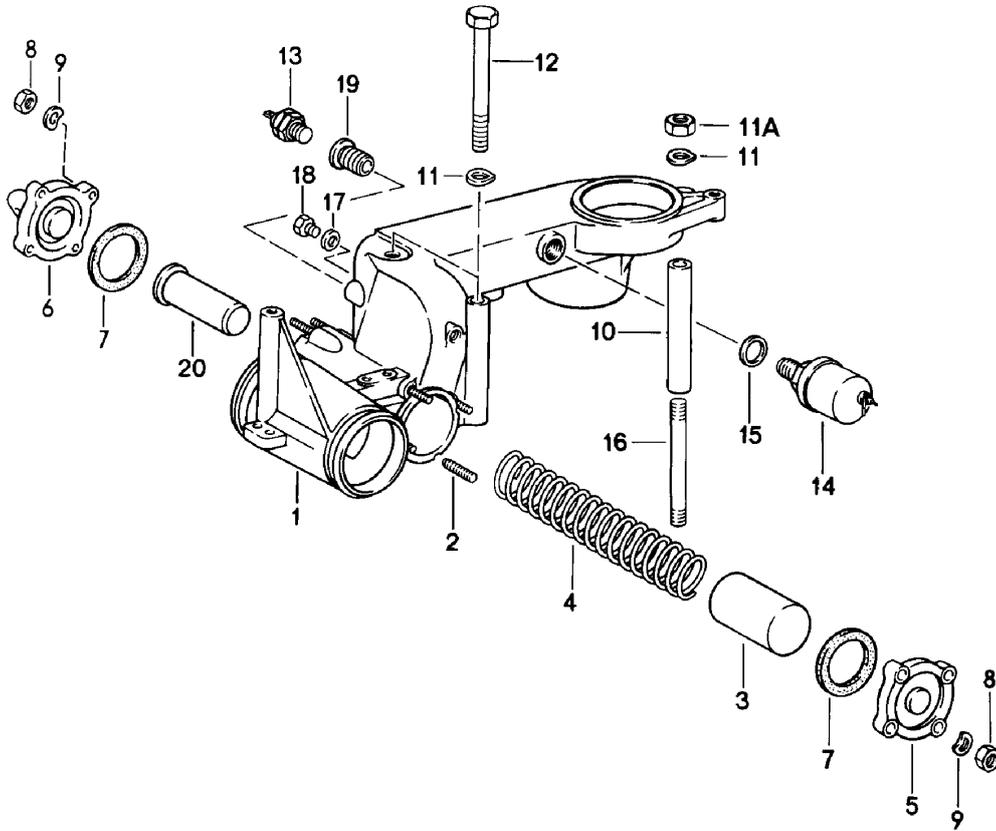

Model: 911 78 Model life 1978>>1983

Pos	Part Number	Description	Remark	Qty	Model
		K-jetronic II			TURBO
1	930 110 018 03	Valve housing		1	
2	999 062 127 02	Stud M 6 X 25		8	
-	999 072 005 01	Hexagon nut AM 6 X 12		2	
-	999 504 004 00	Threaded insert M 8 X 2 D		2	
-	999 504 116 00	Threaded insert M 10 X 1 X 1 D		1	
-	999 504 117 00	Threaded insert M 18 X 1,5 X 0,50		1	
3	930 110 151 00	Piston		1	
-	930 110 160 00	Spring guide		1	
4	930 110 157 00	Compression spring		1	
5	930 110 156 06	Lid		1	
5	930 110 156 09	Lid		1	
6	930 110 056 02	Lid		1	
7	930 110 149 00	Gasket		2	
8	900 076 010 02	Nut M 6		8	
8	900 076 010 0B	Nut M 6		8	
9	N 012 226 5	Spring washer B 6		8	
9	N 011 524 7	Washer A 6,4		1	
9	N 011 524 27	Washer A 6,4		1	
10	930 110 332 00	Spacer tube		1	
11	N 012 241 8	Spring washer B 8		3	
11A	900 076 025 02	Hexagon nut M 8	79-	1	
11A	900 076 064 02	Hexagon nut M 8	79-	1	
12	900 074 264 02	Hexagon-head bolt M 8 X 135	78	3	
12		Hexagon-head bolt M 8 X 135	79-	2	
13	930 606 101 00	Switch		1	
14	993 606 103 00	Pressure transmitter Boost pressure		1	
14	993 606 103 01	Pressure transmitter Boost pressure		1	
15	900 123 009 30	Sealing ring		1	
15	900 123 106 30	Sealing ring A 18 X 24		1	
16	999 062 234 02	Stud BM 8 X 135	79-	1	
19	930 110 367 01	Threaded insert M 10 X 1 X 1D		1	
20	930 110 160 00	Spring guide		1	

Model: 911 78

Model life 1978>>1983

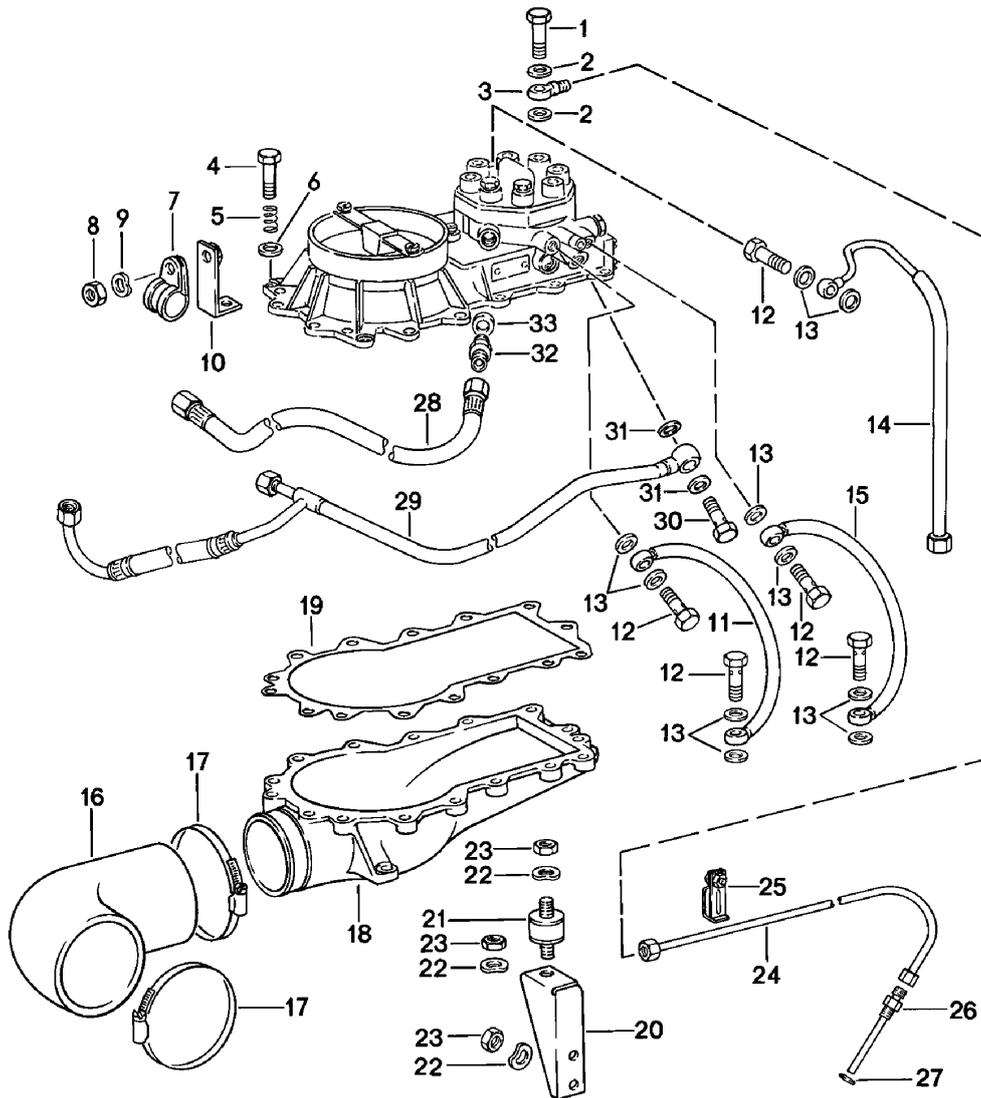

Model: 911 78

Model life 1978>>1983

Pos	Part Number	Description	Remark	Qty	Model
		K-jetronic III			TURBO
1	930 110 547 00	Banjo bolt		6	
1	930 110 547 01	Banjo bolt		6	
2	900 123 144 30	Sealing ring A 10 X 13,5		12	
3	999 215 002 02	Ring piece		6	
4	900 067 011 02	Pan-head screw		4	
4	900 067 011 03	Pan-head screw		4	
4	900 067 011 02	Pan-head screw M 6 X 20		4	
4	900 067 011 03	Pan-head screw M 6 X 20		4	
4	900 067 089 02	Pan-head screw M 6 X 25		10	
4	900 067 089 01	Pan-head screw M 6 X 25		10	
4	900 075 341 02	Combination screw M 6 X 25		1	
4	900 075 341 01	Combination screw M 6 X 25		1	
5	911 110 364 00	Compression spring		11	
6	N 012 226 5	Spring washer B 6		15	
7	999 511 085 02	Clamp		1	
8	900 075 057 02	Hexagon-head bolt M 6 X 16		1	
8	900 075 057 03	Hexagon-head bolt M 6 X 16		1	
9	N 012 226 5	Spring washer B 6		1	
10	930 110 434 01	Clip		1	
11	930 110 303 01	Fuel line Intake Start valve		1	
11	930 110 303 02	Fuel line Intake Start valve		1	
12	911 110 899 00	Banjo bolt		5	
13	900 123 115 30	Sealing ring A 8 X 11,5		10	
14	930 110 302 01	Fuel line Intake Warm-up valve		1	
15	930 110 305 02	Fuel line Return line Warm-up valve		1	
15	930 110 305 03	Fuel line Return line Warm-up valve		1	
16	930 110 137 02	Hose elbow		1	
17	999 512 350 02	Hose clamp		2	
18	930 110 035 04	Lower part		1	
18		Lower part		1	
-	999 062 022 02	Stud M 8 X 12		2	
19	930 110 394 00	Gasket		1	
20	930 110 133 00	Retaining bracket		1	
21	930 110 194 00	Bonded rubber buffer		3	
22	N 012 241 8	Spring washer B 8		7	
23	900 076 025 02	Hexagon nut M 8		7	

Model: 911 78 Model life 1978>>1983

Pos	Part Number	Description	Remark	Qty	Model
23	900 076 064 02	Hexagon nut M 8		7	
24	930 110 041 02	Injection line Cylinder 1		1	
24	930 110 042 02	Injection line Cylinder 2		1	
24	930 110 043 02	Injection line Cylinder 3		1	
24	930 110 044 01	Injection line Cylinder 4		1	
24	930 110 045 02	Injection line Cylinder 5		1	
24	930 110 046 02	Injection line Cylinder 6		1	
25	930 110 432 02	Pipe clamp for 2 Lines		1	
25	930 110 606 00	Pipe clamp for 2 Lines		1	
25	930 110 606 01	Pipe clamp for 2 Lines		1	
(25)	PCG 110 606 01	Rubber ply for Pipe clamp Lines It is necessary to rework		1	
25	930 110 432 03	Pipe clamp for 3 Lines		3	
25	930 110 607 00	Pipe clamp for 3 Lines		3	
25	930 110 607 01	Pipe clamp for 3 Lines		3	
(25)	PCG 110 606 01	Rubber ply for Pipe clamp Lines It is necessary to rework		3	
26	930 110 225 02	Injector valve		6	
27	900 123 144 30	Sealing ring A 10 X 13,5		6	
28	930 110 301 04	Fuel line Intake	-80	1	
28	930 110 301 05	Fuel line Intake	81-	1	
29	930 110 304 03	Fuel line Return line	-79	1	
29		Fuel line Return line		1	
30	900 175 020 02	Banjo bolt		1	
30	900 175 020 01	Banjo bolt		1	
30	N 021 071 2	Banjo bolt		1	
31	900 123 101 30	Sealing ring		2	

Model: 911 78

Model life 1978>>1983

Pos	Part Number	Description	Remark	Qty	Model
32	N 020 704 2	A 12 X 18 Connection piece		1	
32		Connection piece		1	
33	900 123 116 30	Sealing ring A 12 X 15,5		1	

Model: 911 78

Model life 1978>>1983

Pos	Part Number	Description	Remark	Qty	Model
		Turbocharging			TURBO
1	930 123 003 01	Turbocharger		1	
2	900 081 004 02	Stud		4	
		M 8 X 20			
3	900 081 051 02	Stud		4	
		M 10 X 35			
4	930 123 191 01	Gasket		2	
5	930 123 121 02	Bracket		1	
6	930 123 123 00	Spacer tube		1	
7	900 910 099 02	Lock nut		4	
		M 10			
8	930 107 123 01	Gasket		1	
9	930 107 124 01	Oil pipe		1	
9	930 107 124 03	Oil pipe		1	
10	999 084 052 02	Lock nut		2	
		M 8			
11	930 107 125 03	Oil pipe		1	
11	930 107 125 07	Oil pipe		1	
		It is necessary to rework			
12	900 123 007 30	Sealing ring		2	
		A 14 X 18			
13	930 107 706 00	Banjo bolt		1	
14	N 012 226 5	Spring washer		1	
		B 6			
15	999 072 005 09	Hexagon nut		1	
		M 6 X 12			
15	999 072 005 01	Hexagon nut		1	
		M 6 X 12			
16	930 110 165 02	Intake pipe		1	
17	930 110 158 01	Rubber sleeve		2	
		70x5x54			
18	999 512 250 02	Threaded clamp		4	
18	999 512 351 02	Hose clamp		4	
19	930 110 192 01	Pressure line		1	
19A	999 701 473 40	Round seal		1	
20	930 110 230 00	Sealing ring		1	
21	930 107 001 07	Oil collection container	-82	1	
21		Oil collection container		1	
22	999 512 341 02	Clamp		2	
23	930 107 113 01	Retaining bracket		1	
24	930 107 116 01	Gasket		1	
25	N 012 241 8	Spring washer		2	
		B 8			
26	999 084 052 02	Lock nut		2	
		M 8			
27	900 123 055 30	Sealing ring		1	
		A 12 X 17			
28	900 219 006 02	Screw plug		1	
		M 12 X 1,5			
28	900 219 006 01	Screw plug		1	
		M 12 X 1,5			
29	930 107 394 02	Connecting hose		1	
30	999 512 252 02	Hose clamp		2	
31	964 107 005 21	Oil pump		1	
32	999 707 289 40	Round seal		1	
		47 X 2			
33	999 113 246 40	Radial sealing ring		1	
34	930 105 197 05	Gasket		1	
35	N 012 226 5	Spring washer		3	
		B 6			
36	900 074 111 02	Hexagon-head bolt		3	
		M 6 X 50			
37	900 123 018 30	Sealing ring		2	

Model: 911 78

Model life 1978>>1983

Pos	Part Number	Description	Remark	Qty	Model
38	900 175 005 02	A 16 X 20 Banjo bolt		1	
39	930 107 338 00	Oil pipe		1	
40	930 107 336 03	Oil pipe		1	
-	999 239 006 40	Hose 8 X 14		*	
-	999 239 034 40	Hose 7,3 X 3 380 MM		*	
41				1	
42	999 512 160 02	Hose clamp		2	
42	PCG 512 160 02	Hose clamp		2	
43	930 123 053 01	Control line		1	
44	930 123 043 04	I Vent line		1	
44		Vent line		1	
45	900 175 020 02	Banjo bolt		2	
45	900 175 020 01	Banjo bolt		2	
45	N 021 071 2	Banjo bolt		2	
46	900 123 116 30	Sealing ring A 12 X 15,5		4	

Model: 911 78

Model life 1978>>1983

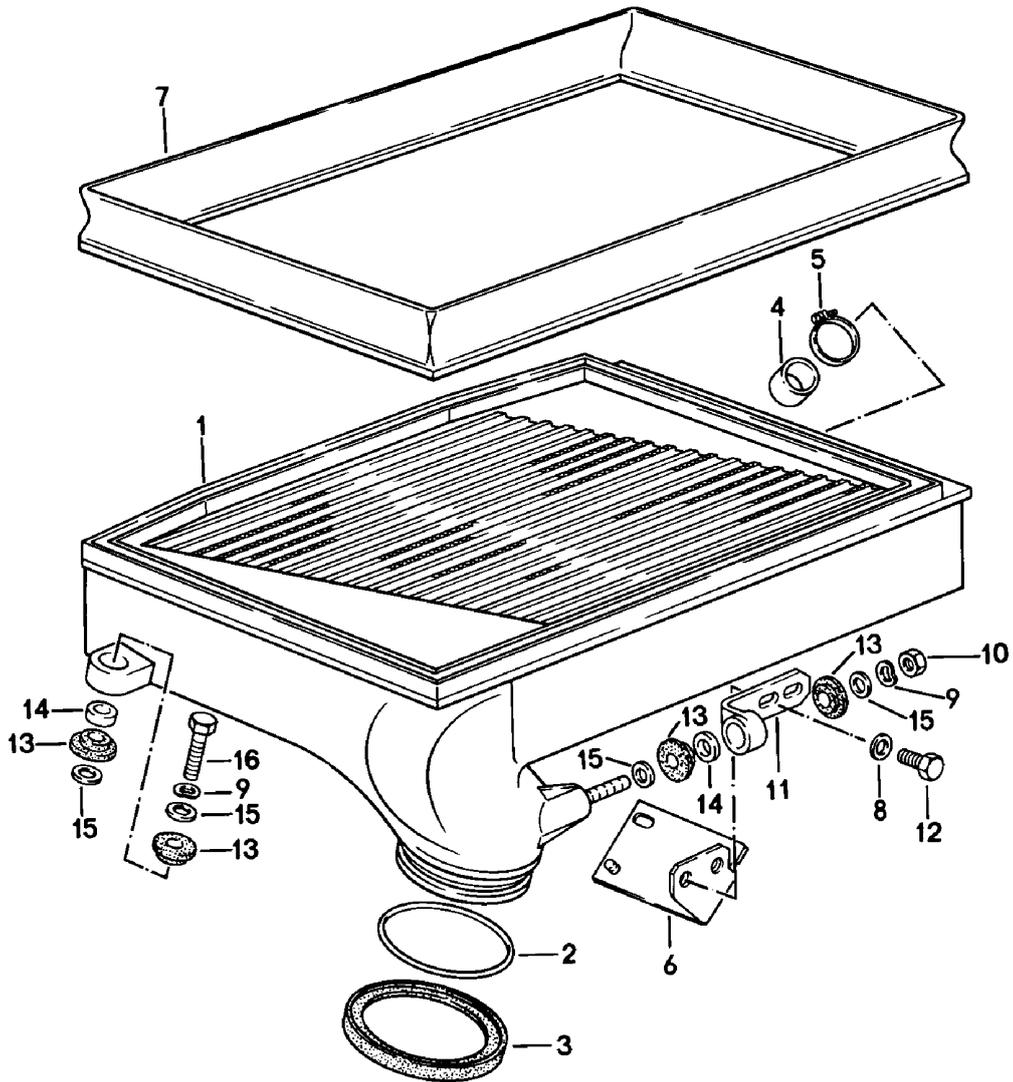

Model: 911 78

Model life 1978>>1983

Pos	Part Number	Description	Remark	Qty	Model
		Charge air cooler			TURBO
1	930 110 233 03	Charge air cooler		1	
1	930 110 233 07	Charge air cooler		1	
2	999 701 469 40	Round seal		3	
3	930 110 379 00	Sealing ring		1	
4	930 110 256 01	Cap	-82	1	
5	999 512 045 02	Hose clamp		1	
6	930 110 224 01	Mounting plate		1	
7	930 110 285 01	Gasket		1	
7	930 110 285 03	Gasket		1	
8	900 025 007 02	Washer B 8,4		4	
8	900 025 007 03	Washer B 8,4		4	
9	N 012 241 8	Spring washer B 8		7	
10	900 076 025 02	Hexagon nut M 8		3	
10	900 076 064 02	Hexagon nut M 8		3	
11	930 110 223 02	Support		1	
12	900 075 087 02	Hexagon-head bolt		2	
12	900 075 087 03	Hexagon-head bolt		2	
12	900 075 087 02	Hexagon-head bolt M 8 X 16		2	
12	900 075 087 03	Hexagon-head bolt M 8 X 16		2	
13	930 113 430 00	Rubber mounting		6	
14	930 110 232 00	Spacer sleeve		3	
15	900 151 008 02	Washer 8,4		6	
16	900 074 134 02	Hexagon-head bolt M 8 X 45		2	
-	930 110 234 02	Air guide	/L (D)	1	
-	930 110 234 03	Air guide	(D)	1	

Model: 911 78

Model life 1978>>1983

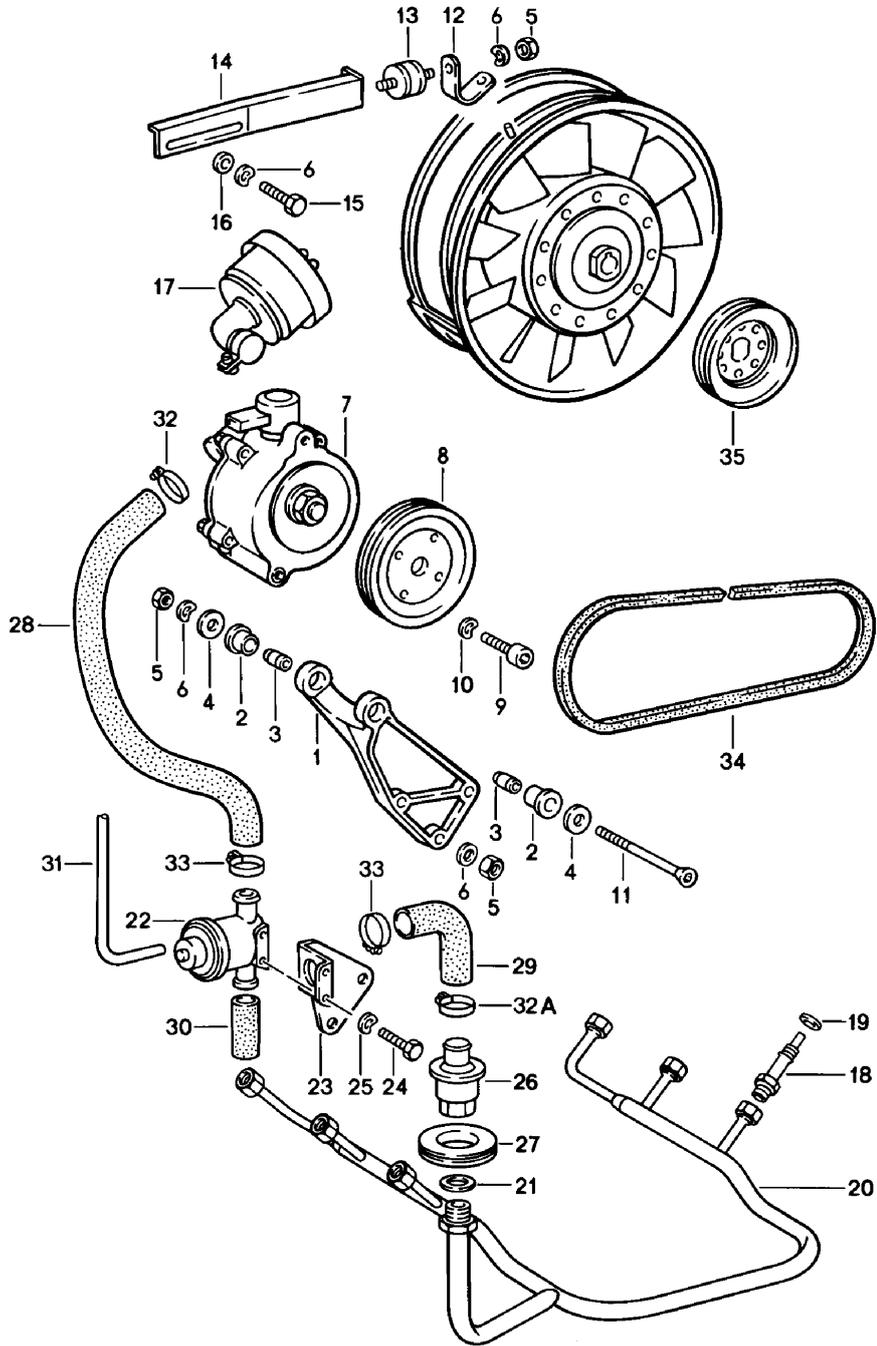

Model: 911 78 Model life 1978>>1983

Pos	Part Number	Description	Remark	Qty	Model
		Air injection			911 SC
1	911 113 113 02	Bracket		1	
2	911 113 121 00	Rubber mounting		2	
3	911 113 122 00	Spacer sleeve		2	
4	900 151 008 02	Washer B 8,4		1	
(4)	911 113 162 00	Washer		1	
5	900 076 025 02	Hexagon nut M 8		6	
5	900 076 064 02	Hexagon nut M 8		6	
6	N 012 241 8	Spring washer B 8		6	
7	911 113 111 03	Air pump		1	
7	911 113 111 04	Air pump	-80	1	
7	930 113 122 00	Air pump	81-	1	
8	930 113 158 00	Pulley		1	
9	900 067 008 02	Pan-head screw M 6 X 12		4	
9	900 067 008 03	Pan-head screw M 6 X 12		4	
10	N 012 226 5	Spring washer		4	
11	900 249 006 02	Countersunk-head screw M 8 X 120		1	
12	911 113 126 02	Retaining bracket		1	
13	930 110 194 00	Bonded rubber buffer		2	
14	911 113 125 02	Support		1	
15	900 075 085 02	Hexagon-head bolt M 8 X 20		1	
16	900 025 007 02	Washer 8,4		1	
16	900 025 007 03	Washer 8,4		1	
17	911 113 117 02	Air cleaner		1	
-	930 113 401 00	Filter cartridge		1	
18	911 113 145 02	Union		6	
18	911 113 145 04	Union		6	
19	900 123 033 20	Sealing ring A 10 X 13,5 CU		6	
20	911 113 043 01	Air tube		1	
21	900 123 060 30	Sealing ring A 24 X 29		1	
22	930 113 147 01	Diverter valve	79-80	1	
22		Diverter valve		1	
23	930 113 146 01	Support for Diverter valve		1	
24	999 072 005 09	Hexagon nut M 6 X 12		2	
24	999 072 005 01	Hexagon nut M 6 X 12		2	
25	N 012 226 5	Spring washer B 6		2	
26	911 113 115 01	Check valve	-81	1	
26		Check valve		1	
27	911 113 146 00	Gasket		1	
28	930 113 138 03	Hose Air pump Diverter valve Together with 911.113.111.04	79-	1	
(28)	911 113 118 02	Hose Air pump	-78	1	

Model: 911 78

Model life 1978>>1983

Pos	Part Number	Description	Remark	Qty	Model
(28)	911 113 118 04	Check valve Together with 911.113.111.02 Hose Air pump	-78	1	
29	930 113 137 01	Check valve Together with 911.113.111.04 Hose Diverter valve		1	
30	930 113 139 02	Check valve Hose Diverter valve		1	
-	999 239 003 40	Engine cover Rear Hose 3,2 X 7		*	
31		750 MM		1	
32	999 512 038 02	Hose clamp S 27/9		1	
32	PCG 512 038 02	Hose clamp S 27/9		1	
32A	PCG 512 237 02	Hose clamp S 26/9		1	
33	999 512 296 02	Hose clamp S 25/7		2	
34	900 192 005 50	Narrow v-belt 9,5 X 975		1	
35	911 106 208 00	Pulley		1	

Model: 911 78

Model life 1978>>1983

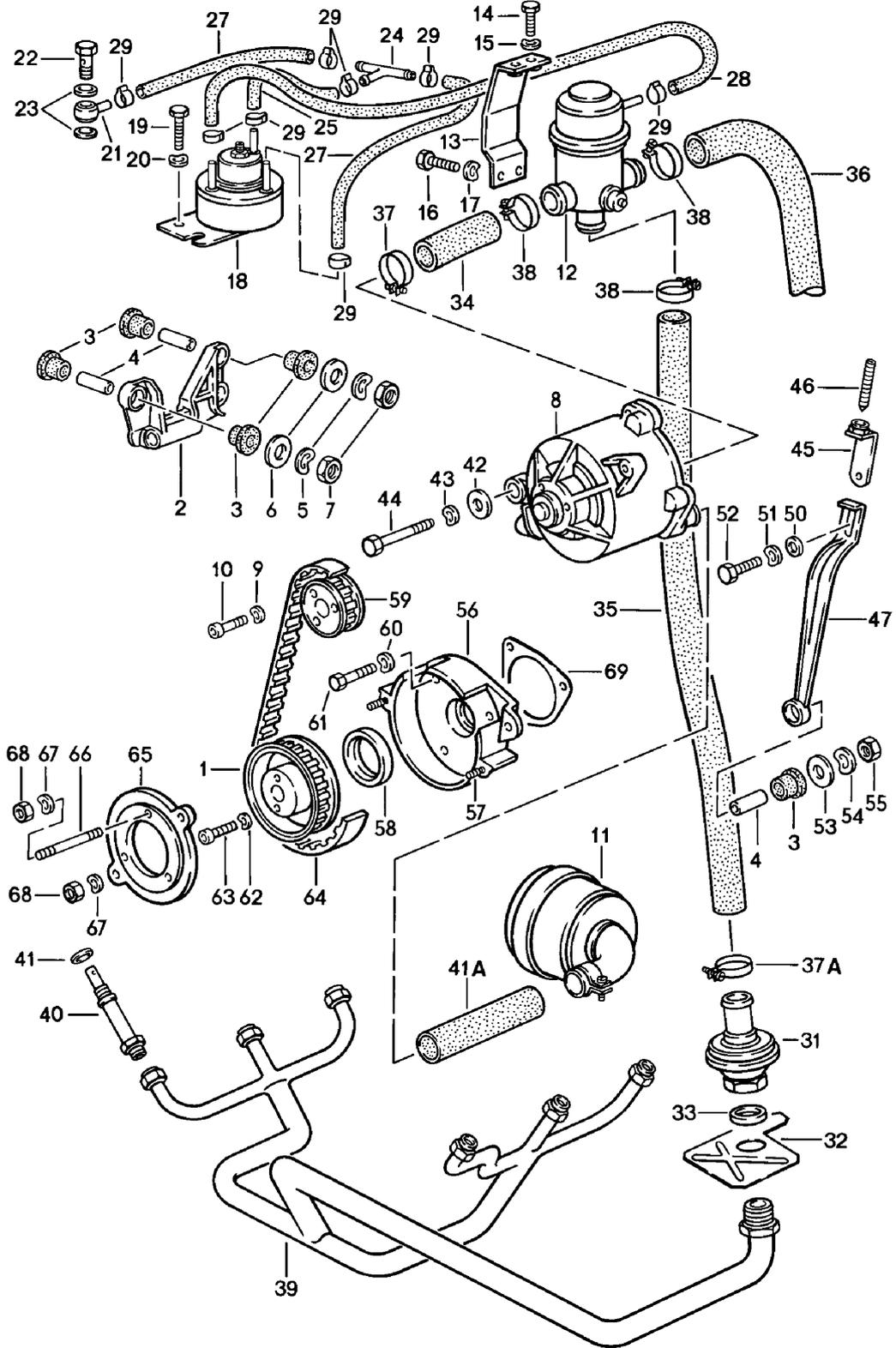

Model: 911 78

Model life 1978>>1983

Pos	Part Number	Description	Remark	Qty	Model
		Air injection			TURBO
1	930 113 025 02	Pulley		1	
2	930 113 159 02	Bracket		1	
2	930 113 159 03	Bracket		1	
-	900 025 007 02	Washer 8,4		1	
-	900 025 007 03	Washer 8,4		1	
3	930 113 161 00	Rubber mounting		8	
4	930 113 163 00	Spacer sleeve		4	
5	N 012 241 8	Spring washer B 8		3	
6	900 151 008 02	Washer B 8,4		3	
7	900 076 025 02	Hexagon nut M 8		3	
7	900 076 064 02	Hexagon nut M 8		3	
8	930 113 114 01	Air pump		1	
9	N 012 226 5	Spring washer A 6		3	
10	900 067 089 02	Pan-head screw M 6 X 25		3	
10	900 067 089 01	Pan-head screw M 6 X 25		3	
11	930 113 120 01	Air cleaner		1	
-	930 113 401 00	Filter cartridge		1	
12	930 113 127 00	Diverter valve		1	
13	930 113 112 00	Retaining bracket		1	
14	N 010 217 9	Hexagon-head bolt M 6 X 20		2	
15	N 012 226 5	Spring washer B 6		2	
16	900 075 014 02	Hexagon-head bolt M 6 X 18		2	
16	900 075 014 03	Hexagon-head bolt M 6 X 18		2	
17	N 012 226 5	Spring washer B 6		2	
18	930 113 126 02	Control valve		1	
19	999 072 005 09	Hexagon nut M 6 X 12		2	
19	999 072 005 01	Hexagon nut M 6 X 12		2	
20	N 012 226 5	Spring washer B 6		2	
21	911 110 382 00	Ring piece		1	
22	N 023 053 2	Banjo bolt		1	
23	900 123 033 20	Sealing ring A 10 X 13,5 CU		2	
24	999 137 004 40	T-piece		1	
-	999 239 014 40	Hose 3,5 X 8,5		*	
25		60 MM		1	
27		75 MM		2	
28		370 MM		1	
29	311 133 343 A	Hose clamp		8	
31	911 113 115 01	Check valve	-81	1	
31		Check valve		1	
32	930 113 135 01	Heat shield		1	
32		Heat shield		1	
33	900 123 060 30	Sealing ring A 24 X 29		2	

Model: 911 78

Model life 1978>>1983

Pos	Part Number	Description	Remark	Qty	Model
34	930 113 118 01	Hose		1	
35	930 113 181 00	Hose		1	
36	930 113 182 00	Air hose		1	
37	999 512 038 02	Hose clamp S 28/9 ZY		1	
37	PCG 512 038 02	Hose clamp S 28/9 ZY		1	
37A	999 512 237 02	Hose clamp S 26/9		1	
38	N 024 162 1	Hose clamp S 25/9 ZY		3	
39	930 113 043 02	Air tube		1	
40	911 113 145 02	Union		6	
40	911 113 145 04	Union		6	
41	900 123 033 20	Sealing ring A 10 X 13,5 CU		6	
41A	999 239 004 40	Breather hose 22 X 31 X 80		1	
42	900 025 007 02	Washer B 8,4		2	
42	900 025 007 03	Washer B 8,4		2	
43	N 012 241 8	Spring washer B 8		1	
44	N 010 391 4	Hexagon-head bolt M 8 X 100		1	
45	930 113 187 01	Clamping bracket		1	
46	900 068 004 02	Threaded pin M 8 X 45		1	
47	930 113 171 00	Support		1	
50	900 025 007 02	Washer B 8,4		1	
50	900 025 007 03	Washer B 8,4		1	
51	N 012 241 8	Spring washer		1	
52	900 075 099 02	Hexagon-head bolt M 8 X 30		1	
52	900 075 099 03	Hexagon-head bolt M 8 X 30		1	
53	900 151 008 02	Washer B 8,4		1	
54	N 012 241 8	Spring washer B 8		1	
55	900 076 025 02	Hexagon nut M 8		1	
55	900 076 064 02	Hexagon nut M 8		1	
56	930 113 031 04	Intermediate flange	-79	1	
56		Intermediate flange		1	
57	999 062 055 02	Stud BM 6 X 12		2	
57	999 062 009 02	Stud BM 8 X 28		1	
57	900 060 105 01	Stud BM 8 X 28		1	
58	999 113 464 40	Sealing ring		1	
59	930 113 017 06	Gear wheel II		1	
60	N 012 226 5	Spring washer B 6		3	
61	900 075 057 02	Hexagon-head bolt M 6 X 16		2	
61	900 075 057 03	Hexagon-head bolt		2	

Model: 911 78

Model life 1978>>1983

Pos	Part Number	Description	Remark	Qty	Model
62	N 012 226 5	M 6 X 16 Spring washer A 6		2	
63	900 067 013 02	Pan-head screw M 6 X 35		2	
64	999 192 131 50	Toothed belt 70 Teeth		1	
65	930 113 033 02	Lid		1	
66	999 062 123 02	Stud BM 6 X 45		3	
67	N 012 226 5	Spring washer B 6		5	
68	900 076 010 02	Nut M 6		5	
68	900 076 010 0B	Nut M 6		5	
69	930 105 197 03	Gasket		1	

Model: 911 78

Model life 1978>>1983

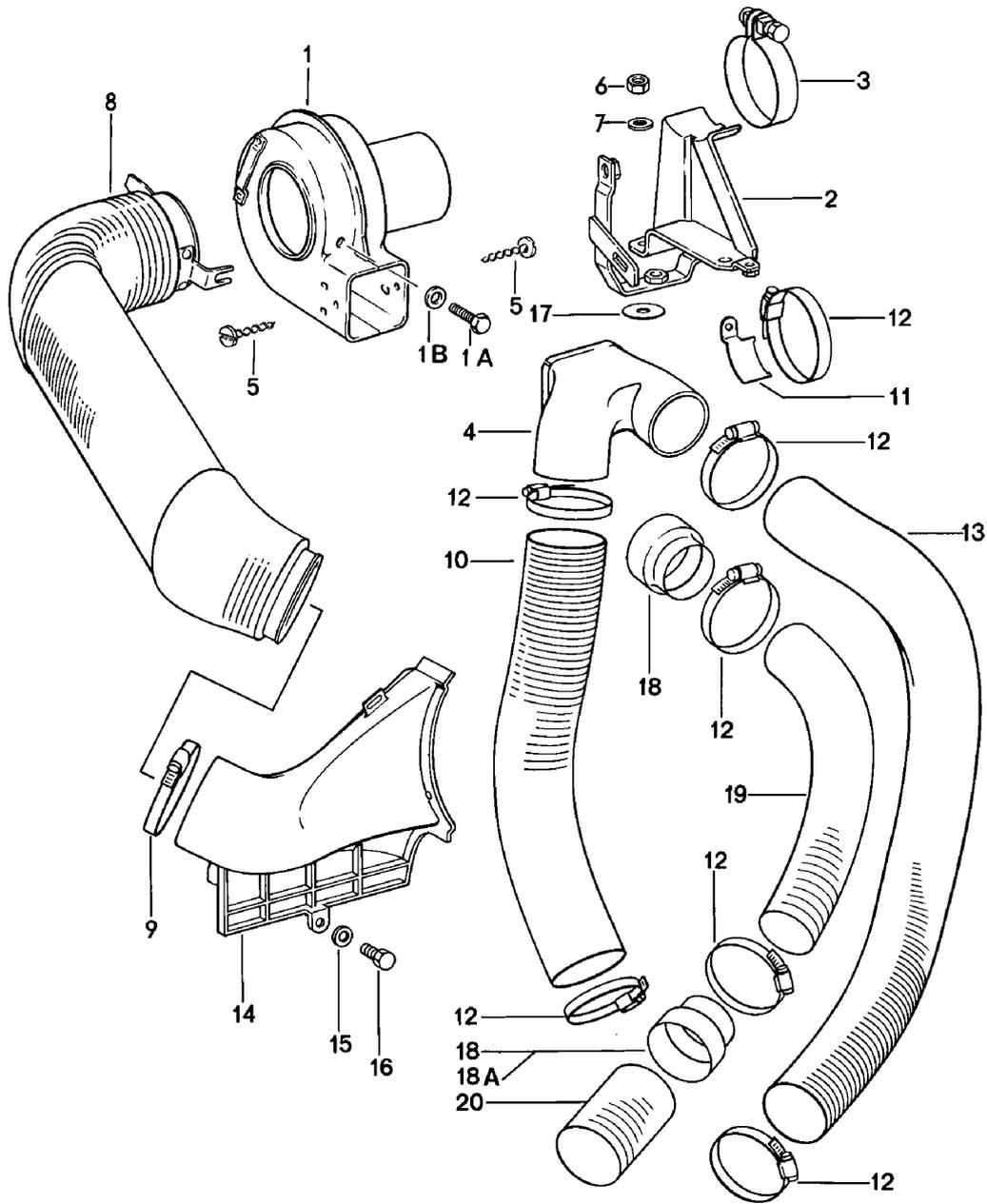

Model: 911 78 Model life 1978>>1983

Pos	Part Number	Description	Remark	Qty	Model
		Blower Engine			911 SC
1	911 624 151 02	Blower		1	
(1)	911 624 901 00	Suction housing von ZSB 91162415102		1	
1	911 624 151 03	Blower		1	
1A	N 010 210 13	Hexagon-head bolt M 6 X 10	80-	1	
1B	N 011 524 7	Washer 6,4	80-	1	
1B	N 011 524 27	Washer 6,4	80-	1	
2	911 211 139 02	Support	-79	1	
2		Support		1	
-	999 513 003 40	Tie-wrap		1	
3	999 512 244 02	Clamp SP 77/20		1	
4	911 211 135 02	Distributing piece		1	
5	900 143 049 07	Tapping screw BZ 3,5 X 9,5		2	
6	900 084 004 03	Hexagon nut M 8		2	
6	900 084 004 02	Hexagon nut M 8		2	
7	900 025 007 02	Washer 8,4		2	
7	900 025 007 03	Washer 8,4		2	
-	999 511 069 02	Clamp 12/15 Return line Warm-up valve		1	
-	999 511 069 0C	Clamp 12/15 Return line Warm-up valve		1	
-	900 075 057 02	Hexagon-head bolt M 6 X 16		1	
-	900 075 057 03	Hexagon-head bolt M 6 X 16		1	
-	999 072 005 09	Hexagon nut M 6 X 12		2	
-	999 072 005 01	Hexagon nut M 6 X 12		2	
-	N 012 226 5	Spring washer B 6		3	
-	999 511 081 02	Pipe clamp 1100 2 X 8/15 Mount Injection line Cyl. 2 and 3		1	
-		Pipe clamp 1100 2 X 11/15 Mount Injection line Cylinder 1 Mixture control unit Warm-up valve		1	
(8)	911 211 272 02	Hose M >> 640 1795 M >> 630 8249 M >> 630 2599 M >> 630 9039		1	

Model: 911 78 Model life 1978>>1983

Pos	Part Number	Description	Remark	Qty	Model
8	930 211 031 00	Hose M 640 1796 >> M 630 8250 >> M 630 2600 >> M 630 9040 >>	80-	1	
9	930 211 329 03	Hose clamp 76-92 X 9		2	
10	901 211 195 00	Heater hose	/L	1	
10	901 211 195 01	Heater hose	/L	1	
11	911 211 277 00	Support		2	
11	911 211 277 02	Support		1	M399/559
11	911 211 277 03	Support		1	
12	999 512 349 02	Hose clamp 51-72 X 9	-81	6	
12	999 512 349 01	Hose clamp 51-72 X 9		6	
12	999 512 349 0B	Hose clamp 51-72 X 9	-81	6	
12	999 512 349 02	Hose clamp SGT 50-70/9		6	
12	999 512 349 01	Hose clamp SGT 50-70/9		6	
12	999 512 349 0B	Hose clamp SGT 50-70/9		6	
12	999 512 348 02	Hose clamp 40-60	-81	6	M399/559
12		Hose clamp SGT 40-60/9		6	M398/559
13	911 211 522 00	Heater hose	/R	1	
13	911 211 522 01	Heater hose	/R	1	
14	930 106 326 01	Hot air socket		1	
15	999 025 108 02	Washer		2	
16	999 072 005 09	Hexagon nut M 6 X 12		2	
16	999 072 005 01	Hexagon nut M 6 X 12		2	
17	911 211 401 00	Rubber washer		2	M399/559
18	911 211 275 01	Reducing socket		2	M399/559
18A		Reducing socket		1	M559
19	911 211 274 00	Heater hose 50 \$		1	M399/559
20	911 211 273 00	Heater hose 60 \$		1	M399/559
20	911 211 273 02	Heater hose 60 \$		1	M399/559

Model: 911 78

Model life 1978>>1983

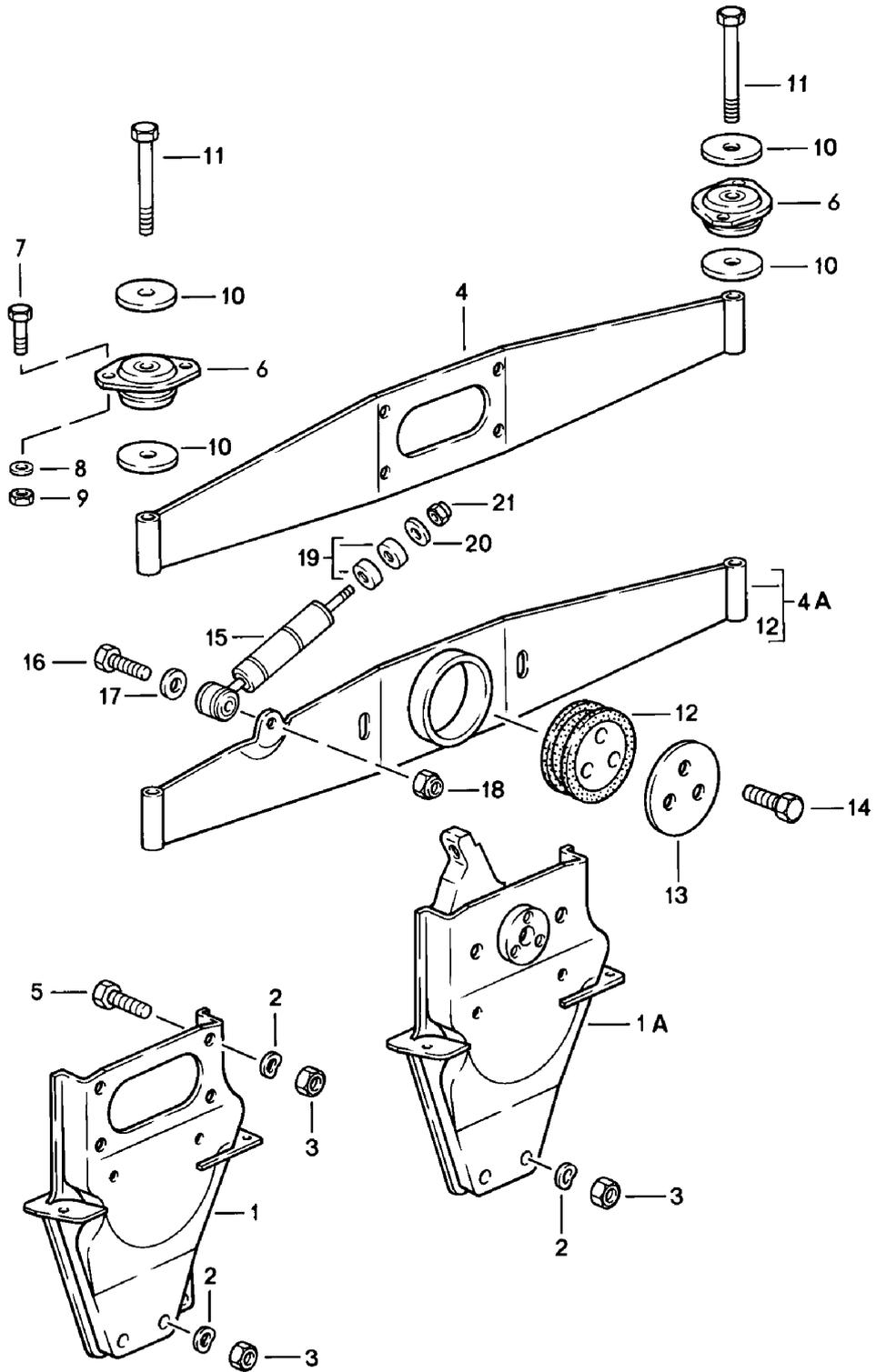

Model: 911 78 Model life 1978>>1983

Pos	Part Number	Description	Remark	Qty	Model
1	911 115 014 03	Engine suspension Bracket		1	SC
1	930 115 014 00	Bracket		1	TURBO
1	911 115 014 03	Bracket		1	SC M559
1A	911 115 014 04	Bracket		1	CABRIO
2	N 012 242 3	Spring washer		8	
3	900 157 002 02	Hexagon nut M 10		8	
3	900 157 002 03	Hexagon nut M 10		8	
4	930 375 011 01	Bracket		1	
4A	911 375 011 06	Bracket		1	CABRIO
5	900 156 006 02	Hexagon-head bolt M 10 X 18		4	
6	911 375 043 00	Bearing		2	
6	911 375 043 07	Bearing		2	CABRIO
7	N 010 335 5	Hexagon-head bolt		4	
7	900 075 032 03	Hexagon-head bolt		4	
7	N 010 335 5	Hexagon-head bolt M 8 X 35		4	
7	900 075 032 03	Hexagon-head bolt M 8 X 35		4	
8	900 027 015 02	Lock ring		4	
8	900 027 015 03	Lock ring		4	
8	900 027 015 02	Lock ring B 8		4	
8	900 027 015 03	Lock ring B 8		4	
9	900 076 025 02	Hexagon nut M 8		4	
9	900 076 064 02	Hexagon nut M 8		4	
10	901 305 311 00	Seat		4	
11	N 010 191 2	Hexagon-head bolt M 12 X 1,5 X 95		2	
11	900 082 142 01	Hexagon-head bolt M 12 X 1,5 X 95		2	
12	911 375 043 05	Torsion bearing		1	CABRIO
13	911 375 313 00	End plate		1	CABRIO
14	N 010 275 3	Hexagon-head bolt M 10X35		3	CABRIO
14	900 075 460 01	Hexagon-head bolt M 10X35		3	CABRIO
15	911 375 175 00	Vibration damper		1	CABRIO
15	911 375 175 01	Vibration damper		1	CABRIO
16	N 010 445 2	Hexagon-head bolt M 10X45		1	CABRIO
16	900 074 372 01	Hexagon-head bolt M 10X45		1	CABRIO
17	900 025 008 09	Washer A 10,5		1	CABRIO
17	900 025 008 04	Washer A 10,5		1	CABRIO
18	N 900 876 01	Lock nut		1	CABRIO
18		Lock nut VM 10		1	CABRIO
19	911 375 181 00	Spacer ring		2	CABRIO
20	N 900 662 01	Washer 6,4 X 21,5		1	CABRIO
21	900 910 010 09	Lock nut VM 6		1	CABRIO

Model: 911 78

Model life 1978>>1983

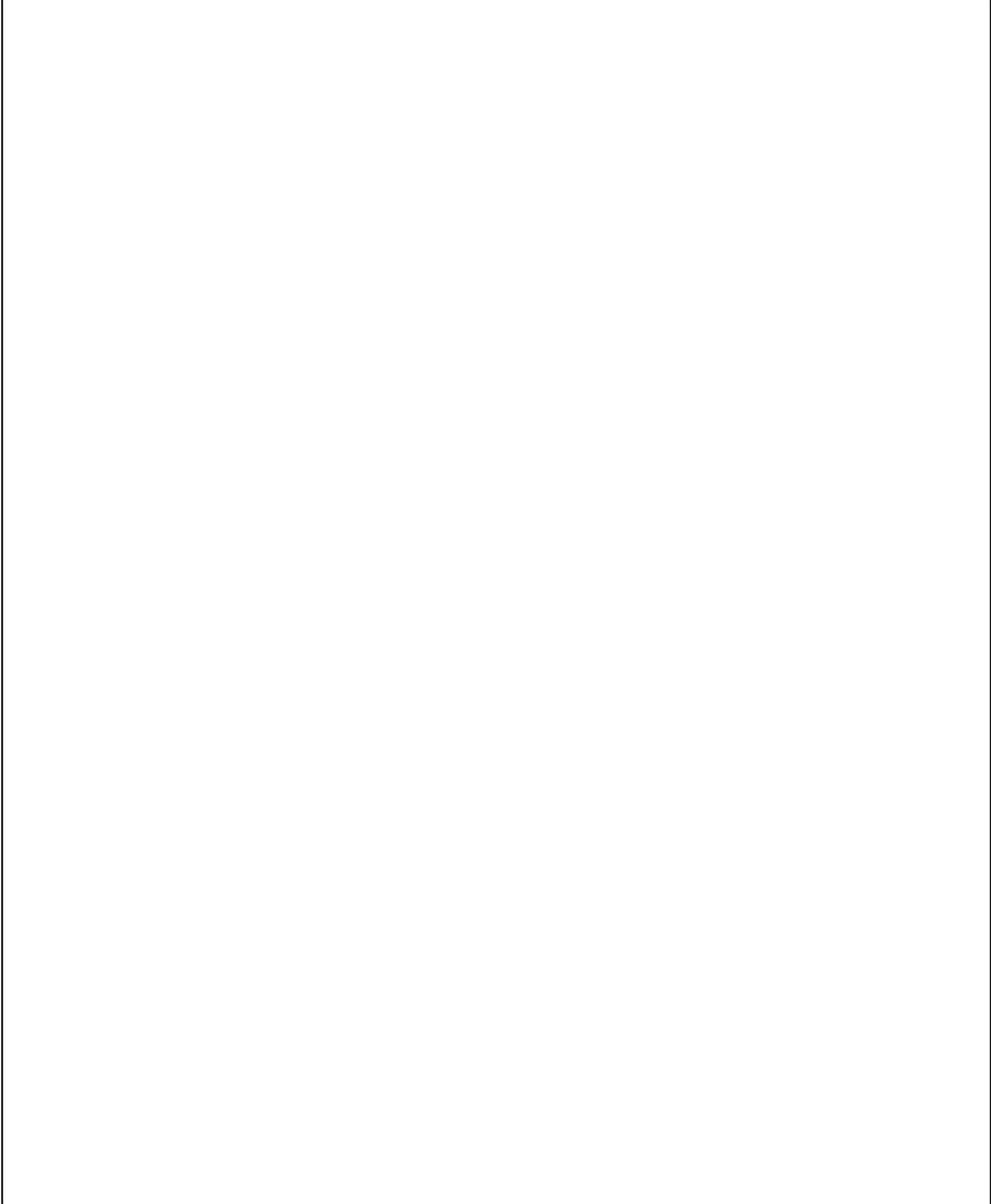

Model: 911 78 Model life 1978>>1983

Pos	Part Number	Description	Remark	Qty	Model
1	PCG 911 111 25	Maintenance set Gasket set Repair kit Gasket set Injector valve Comprising:	74-83	1	
-	999 701 423 40	O-ring		6	
-	911 110 886 03	O-ring		6	
-	999 701 446 40	O-ring		6	
>>	930 100 907 03	Gasket set Cylinder Cylinder head Comprising:		1	SC
-	999 704 172 50	Sealing ring		2	
-	930 104 194 02	Cylinder base gasket		6	
-	930 104 317 00	Ce-seal ring		6	
-	928 104 193 12	Valve stem seal		12	
-	928 104 193 13	Valve stem seal		12	
-	964 104 111 07	Valve stem seal		12	
-	930 105 193 00	Gasket		2	
-	930 105 193 05	Gasket		2	
-	900 031 014 30	Washer 8,4		40	
-	999 701 596 40	O-ring 8,3 - 2,4		2	
-	999 701 598 40	O-ring 20,3 - 2,4		2	
-	999 701 298 40	O-ring 10 - 1,3		2	
-	N 013 804 2	Sealing ring A 6 X 10		2	
-	930 105 197 05	Gasket		3	
-	930 105 191 03	Gasket		1	
-	930 105 192 01	Gasket		1	
-	930 105 192 04	Gasket		1	
-	900 031 011 30	Washer 6,4		19	
-	930 105 194 01	Gasket		2	
-	930 105 195 05	Gasket		2	
-	930 105 195 06	Gasket		2	
-	930 105 195 07	Gasket		2	
-	999 704 173 50	Sealing ring		1	
-	900 123 116 30	Sealing ring A 12 X 16		7	
-	999 707 112 40	Round seal		8	
-	999 707 112 4A	Round seal		8	
-	930 110 197 12	Gasket		6	
-	911 110 394 02	Gasket		1	
-	999 701 423 40	O-ring 6 X 5		6	
-	900 123 115 30	Sealing ring A 8 X 11,5		17	
-	900 123 144 30	Sealing ring 10 X 13,5		1	
-	999 701 395 50	O-ring 7 - 2 B		1	
-	999 701 210 40	O-ring 20 - 2,5		1	
-	999 701 210 4A	O-ring 20 - 2,5		1	
-	911 111 191 01	Gasket		1	
-	911 111 191 02	Gasket		1	
-	930 111 192 01	Gasket		2	

Model: 911 78 Model life 1978>>1983

Pos	Part Number	Description	Remark	Qty	Model
-	930 111 193 01	Gasket		1	
-	930 111 193 04	Gasket		1	
-	930 111 193 05	Gasket		1	
-	930 111 193 07	Gasket		1	
-	911 111 188 02	Support washer		1	
-	911 111 189 03	Gasket		1	
-	900 123 033 20	Sealing ring A 10 X 13,5		6	
-	900 123 060 30	Sealing ring A 24 X 29		1	
-	905 107 191 02	Gasket		1	
-	905 107 191 03	Gasket		1	
-	900 123 008 30	Sealing ring A 14 X 20		1	
-	900 123 116 30	Sealing ring A 12 X 15,5		3	
-	999 701 135 50	O-ring 15 X 2,5		1	
-	900 123 101 30	Sealing ring A 14 X 18		2	
-	930 111 191 01	Gasket		6	
-	900 123 007 70	Sealing ring A 14 X 18		2	
-	999 701 468 40	Round seal		2	
-	911 113 146 00	Gasket		1	
-	911 113 179 02	Gasket		2	
-	911 113 205 02	Sealing rubber		1	
-	999 701 446 40	O-ring		6	
-	900 123 007 30	Sealing ring		1	
-	900 123 005 00	Sealing ring A 12 X 16		8	
>>	930 100 908 02	Gasket set Cylinder Cylinder head Comprising:		1	TURBO
-	999 704 172 50	Sealing ring		6	
-	930 104 194 02	Cylinder base gasket		6	
-	928 104 193 12	Valve stem seal		12	
-	928 104 193 13	Valve stem seal		12	
-	964 104 111 07	Valve stem seal		12	
-	930 105 193 00	Gasket		2	
-	930 105 193 05	Gasket		2	
-	999 701 596 40	O-ring 8,3 - 2,4		2	
-	999 701 598 40	O-ring 20,3 - 2,4		2	
-	999 701 298 40	O-ring 10 - 1,3		2	
-	N 013 804 2	Sealing ring A 6 X 10		2	
-	930 105 197 03	Gasket		3	
-	930 105 191 03	Gasket		1	
-	930 105 192 01	Gasket		1	
-	930 105 192 03	Gasket		1	
-	930 105 192 04	Gasket		1	
-	900 031 011 30	Washer 6,4		19	
-	930 105 194 01	Gasket		2	
-	930 105 195 05	Gasket		2	
-	930 105 195 06	Gasket		2	
-	930 105 195 07	Gasket		2	
-	900 031 014 30	Washer 8,4		42	

Model: 911 78

Model life 1978>>1983

Pos	Part Number	Description	Remark	Qty	Model
-	999 704 173 50	Sealing ring		1	
-	900 123 116 30	Sealing ring A 12 X 16		7	
-	999 707 112 40	Round seal		8	
-	999 707 112 4A	Round seal		8	
-	999 707 289 40	Round seal 47 X 2		1	
-	900 123 007 30	Sealing ring A 14 X 18		2	
-	999 113 246 40	Radial sealing ring		1	
-	900 123 055 30	Sealing ring A 12 X 17		1	
-	930 107 116 01	Gasket		1	
-	900 123 018 30	Sealing ring A 16 X 20		2	
-	930 107 123 01	Gasket		1	
-	900 123 033 20	Sealing ring A 10 X 13,5		26	
-	930 110 197 10	Gasket		12	
-	930 110 149 00	Gasket		2	
-	930 110 122 00	Sealing ring		1	
-	900 123 101 30	Sealing ring A 12 X 18		2	
-	900 123 033 20	Sealing ring A 10 X 13,5		1	
-	930 110 394 00	Gasket		1	
-	900 123 115 30	Sealing ring A 8 X 11,5		10	
-	999 701 395 50	O-ring 7 - 2		1	
-	930 111 192 01	Gasket		2	
-	999 701 468 40	Round seal		3	
-	930 110 230 00	Sealing ring		1	
-	930 110 379 00	Sealing ring		1	
-	930 111 160 01	Gasket		2	
-	930 111 162 01	Gasket		2	
-	911 111 189 03	Gasket		1	
-	930 111 191 01	Gasket		6	
-	930 111 193 01	Gasket		1	
-	930 111 193 04	Gasket		1	
-	930 111 193 05	Gasket		1	
-	930 111 193 07	Gasket		1	
-	930 123 191 01	Gasket		2	
-	999 701 473 40	Round seal		1	
-	930 123 192 01	Gasket		1	
-	930 123 194 01	Gasket		2	
-	999 701 469 40	Round seal		3	
-	999 701 477 40	Round seal		1	
-	911 113 179 02	Gasket		1	
-	911 113 190 01	Gasket		6	
-	900 123 106 30	Sealing ring		1	
-	900 123 116 30	Sealing ring		4	
-	900 123 060 30	Sealing ring		2	
-	930 123 134 04	Gasket		1	
-	999 113 464 40	Sealing ring		1	
-	900 123 005 00	Sealing ring A 12 X 16		8	
-	930 111 156 01	Support washer		1	
-	930 123 132 02	Support washer		1	
>>	930 100 901 04	Gasket set Crankcase		1	
-	999 704 172 50	Comprising: Sealing ring		3	

Model: 911 78 Model life 1978>>1983

Pos	Part Number	Description	Remark	Qty	Model
-	930 103 963 00	Set of piston rings	-80	6	SC
-	930 103 986 00	Set of piston rings	81-	6	SC
-	930 103 968 00	Set of piston rings		6	TURBO
		Set of piston rings - SCHMIDT -			
-	930 103 967 00	Set of piston rings	-80	6	SC
>>	911 100 956 00	Maintenance set for 20,000 km intervals Comprising:	-80	1	SC
-	930 107 764 01	Oil filter		1	
-	930 107 764 03	Oil filter Red	-(IND)	1	
-	930 110 076 00	Fuel filter		1	
-	930 110 076 02	Fuel filter		1	
-	930 105 194 01	Gasket		2	
-	930 105 195 05	Gasket		2	
-	930 105 195 06	Gasket		2	
-	930 105 195 07	Gasket		2	
-	900 084 004 03	Hexagon nut		34	
-	900 084 004 02	Hexagon nut		34	
-	900 031 014 30	Washer		34	
-	911 110 185 02	Filter element		1	
-	930 113 401 00	Filter cartridge		1	
-	900 123 118 30	Sealing ring		2	
-	999 170 162 90	Spark plug		6	
>>	911 100 956 01	Maintenance set for 20,000 km intervals Comprising:	81-	1	SC
-	930 107 764 01	Oil filter		1	
-	930 107 764 03	Oil filter Red		1	
-	928 110 147 05	Fuel filter		1	
-	930 105 194 01	Gasket		2	
-	930 105 195 05	Gasket		2	
-	930 105 195 06	Gasket		2	
-	930 105 195 07	Gasket		2	
-	900 084 004 03	Hexagon nut		34	
-	900 084 004 02	Hexagon nut		34	
-	900 031 014 30	Washer		34	
-	911 110 185 02	Filter element		1	
-	930 113 401 00	Filter cartridge		1	
-	900 123 118 30	Sealing ring		2	
-	999 170 162 90	Spark plug		6	
>>	911 100 988 00	Maintenance set for 20,000 km intervals Comprising:	-80	1	TURBO
-	930 107 764 01	Oil filter		1	
-	930 107 764 03	Oil filter Red	-(IND)	1	
-	930 110 139 00	Fuel filter		1	
-	930 105 194 01	Gasket		2	
-	930 105 195 05	Gasket		2	
-	930 105 195 06	Gasket		2	
-	930 105 195 07	Gasket		2	
-	900 084 004 03	Hexagon nut		34	
-	900 084 004 02	Hexagon nut		34	
-	900 031 014 30	Washer		34	
-	930 110 185 02	Air cleaner cartridge		1	
-	930 113 401 00	Filter cartridge		1	
-	900 123 118 30	Sealing ring		2	
-	900 123 055 30	Sealing ring		1	
-	999 170 128 90	Spark plug		6	
>>	911 100 988 01	Maintenance set	81-	1	TURBO

Model: 911 78 Model life 1978>>1983

Pos	Part Number	Description	Remark	Qty	Model
		for 20,000 km intervals			
		Comprising:			
-	930 107 764 01	Oil filter		1	
-	930 107 764 03	Oil filter	-(IND)	1	
		Red			
-	928 110 147 05	Fuel filter		1	
-	930 105 194 01	Gasket		2	
-	930 105 195 05	Gasket		2	
-	930 105 195 06	Gasket		2	
-	930 105 195 07	Gasket		2	
-	900 084 004 03	Hexagon nut		34	
-	900 084 004 02	Hexagon nut		34	
-	900 031 014 30	Washer		34	
-	930 110 185 02	Air cleaner cartridge		1	
-	930 113 401 00	Filter cartridge		1	
-	900 123 118 30	Sealing ring		2	
-	900 123 055 30	Sealing ring		1	
-	999 170 128 90	Spark plug		6	
>>	930 105 911 00	Chain adjuster	/L -83	1	
		1 set			
		for subsequent installation			
		Comprising:			
-	930 105 063 08	Lid		1	
-	N 016 155 3	Screw plug		1	
		M 14 X 1,5			
-	N 016 155 4	Screw plug		1	
		M 14 X 1,5			
-	900 123 007 30	Sealing ring		1	
		A 14 X 18			
-	930 107 347 03	Oil hose		1	
-	930 107 347 04	Oil hose		1	
-	930 107 347 02	Oil pipe		1	
-	930 107 341 00	Support		1	
-	900 119 059 02	Pan-head screw		1	
		M 4 X 10			
-	900 119 088 01	Pan-head screw		1	
		M 4 X 10			
-	999 511 174 02	Pipe clamp		1	
-	PCG 511 174 02	Pipe clamp		1	
-	930 105 058 03	Chain adjuster		1	
-	999 701 690 40	Round seal		1	
		12 X 1,78			
-	N 021 073 1	Banjo bolt		1	
		LL 3 - 5			
-	900 123 115 30	Sealing ring		2	
		A 8 X 11,5			
-	900 104 003 02	Union nut		1	
		ALL 8			
-	900 104 003 03	Union nut		1	
		ALL 8			
-	N 020 825 1	Cutting ring		1	
		LL 8			
-	930 105 191 03	Gasket		1	
-	900 031 011 30	Washer		10	
		6,4			
-	900 910 012 02	Lock nut		10	
		M 6			
-	900 910 047 09	Lock nut		10	
		M 6			
>>	930 105 912 00	Chain adjuster	/R -83	1	
		1 set			
		for subsequent installation			
		Comprising:			

Model: 911 78

Model life 1978>>1983

Pos	Part Number	Description	Remark	Qty	Model
>>	930 105 912 01	Chain adjuster 1 set for subsequent installation Comprising:	/R -83	1	
-	930 105 064 10	Lid		1	
-	930 107 348 11	Oil hose		1	
-	930 107 348 12	Oil hose		1	
-	930 107 348 09	Oil pipe		1	
-	930 107 348 14	Oil pipe		1	
-	930 107 348 09	Oil pipe		1	
-	930 107 342 01	Support		1	
-	900 119 059 02	Pan-head screw M 4 X 10		1	
-	900 119 088 01	Pan-head screw M 4 X 10		1	
-	999 511 174 02	Pipe clamp		1	
-	PCG 511 174 02	Pipe clamp		1	
-	930 105 058 03	Chain adjuster		1	
-	999 701 690 40	Round seal 12 X 1,78		1	
-	N 021 073 1	Banjo bolt LL 3 - 5		1	
-	900 123 115 30	Sealing ring A 8 X 11,5		2	
-	900 104 003 02	Union nut ALL 8		1	
-	900 104 003 03	Union nut ALL 8		1	
-	N 020 825 1	Cutting ring LL 8		1	
-	930 105 192 01	Gasket		1	
-	930 105 192 03	Gasket		1	
-	930 105 192 04	Gasket		1	
-	900 031 011 30	Washer 6,4		11	
-	900 910 012 02	Lock nut M 6		11	
-	900 910 047 09	Lock nut M 6		11	
-	930 107 342 01	Support		1	
-	900 119 059 02	Pan-head screw M 4 X 10		1	
-	900 119 088 01	Pan-head screw M 4 X 10		1	
-	999 511 174 02	Pipe clamp		1	
-	PCG 511 174 02	Pipe clamp		1	

Model: 911 78

Model life 1978>>1983

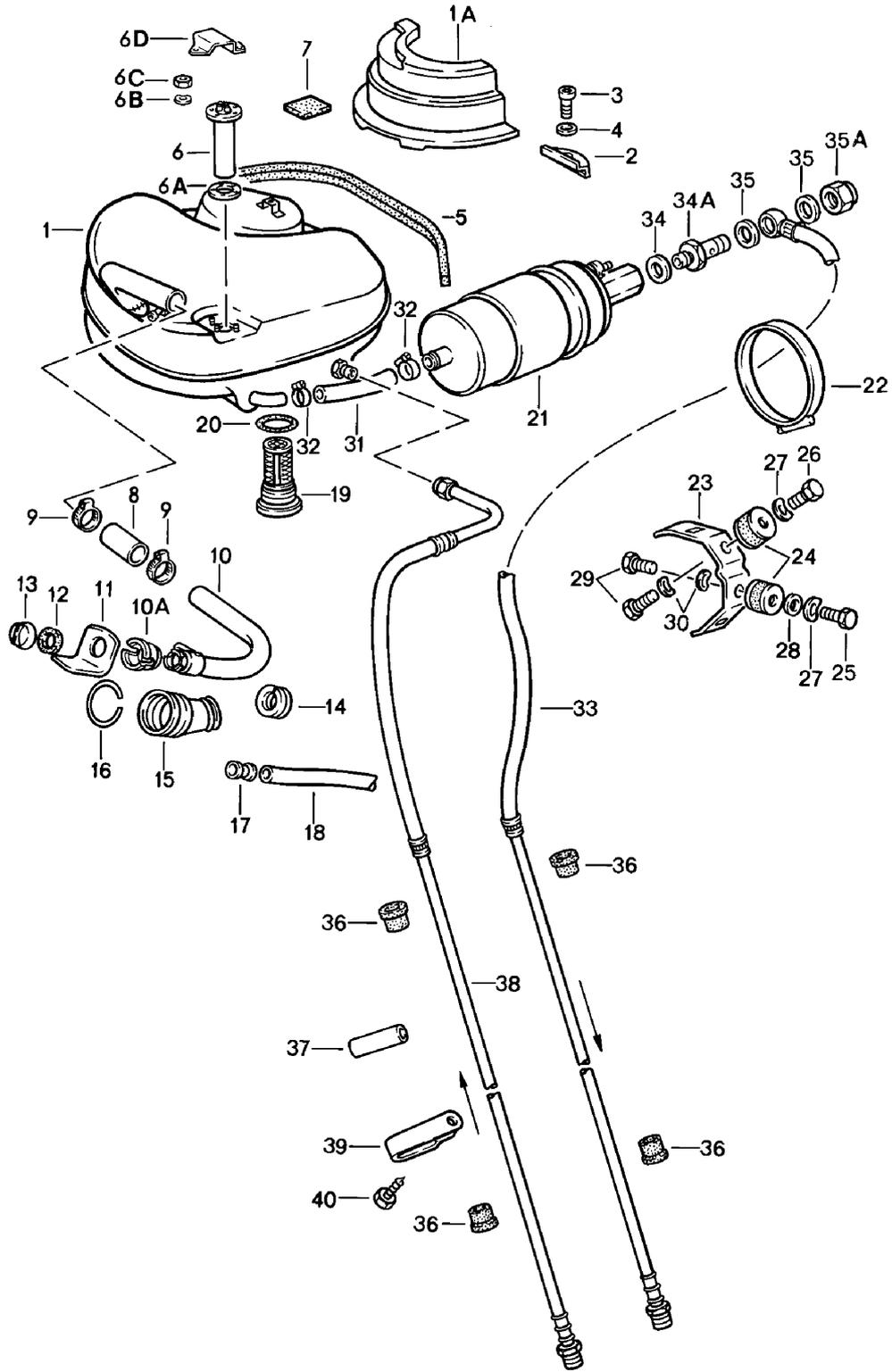

Model: 911 78 Model life 1978>>1983

Pos	Part Number	Description	Remark	Qty	Model
		Fuel system			
		Front			
1	930 201 010 01	Fuel tank	-79	1	
1	930 201 010 03	Fuel tank	80-	1	
1	930 201 010 02	Fuel tank	80-	1	
		80 Liter			
1	930 201 010 04	Fuel tank	80-	1	
		80 Liter			
1	930 201 010 05	Fuel tank	80-	1	
		80 Liter			
-	930 201 010 04	Fuel tank		1	
		Use also:			
		BIS			
		MODELL -79			
1	930 201 010 05	Fuel tank	80-	1	
		80 Liter			
2	901 201 311 00	Bracket		3	
3	900 067 151 02	Pan-head screw		3	
3	900 067 151 0C	Pan-head screw		3	
4	900 025 007 02	Washer		3	
		8,4			
4	900 025 007 03	Washer		3	
		8,4			
5	901 504 932 20	Sealing strap		1	
6	901 741 801 00	Sender		1	
6A	477 919 133	Sealing ring		1	
6A		Sealing ring		1	
6B	900 028 007 02	Spring washer		5	
6B	N 012 222 4	Spring washer		5	
		B 5			
6C	900 076 027 02	Nut		5	
6C	N 011 005 14	Hexagon nut		5	
		M 5			
6C	900 076 091 01	Hexagon nut		5	
		M 5			
6D	901 201 275 30	Cap		1	
		for			
		Sender			
		Yellow			
		Anodised			
(6D)	901 201 275 31	Cap		1	
		for			
		Sender			
		Black			
7	911 201 259 00	Desk pad		2	
(7)	911 201 259 01	Desk pad		1	
8	911 201 515 00	Hose		1	
9	999 512 348 02	Hose clamp		2	
9		Hose clamp		2	
10	911 201 049 02	Filler neck	-79	1	
10	911 201 049 04	Filler neck	80-	1	
-	N 011 524 7	Washer	-79	2	
-	N 011 524 27	Washer		2	
-	N 011 524 7	Washer	-79	2	
		6,4			
-	N 011 524 27	Washer		2	
		6,4			
-	N 012 006 4	Lock ring	80-	2	
-		Lock ring	80-	2	
-	900 910 012 02	Lock nut	-79	2	
-	900 910 047 09	Lock nut		2	
-	999 084 074 02	Lock nut	-79	2	
		M 6			

TURBO

Model: 911 78

Model life 1978>>1983

Pos	Part Number	Description	Remark	Qty	Model
-	900 075 310 02	Hexagon-head bolt M 6 X 12	80-	2	
10A	911 201 269 00	Guide	-79	1	
11	911 201 279 01	Protective flap		1	
12	477 201 557	Gasket	-79	1	
12	944 201 553 00	Gasket	80-	1	
13	911 201 272 00	Fuel tank cap	-79	1	
13	911 201 272 01	Fuel tank cap	80-	1	
13	911 201 272 02	Fuel tank cap	80-	1	
13	911 201 272 00	Fuel tank cap	80-	1	
13	993 201 271 00	Fuel tank cap	80-	1	
14	911 201 095 00	Gasket		1	
15	901 201 591 20	Sleeve		1	
15	901 201 591 21	Sleeve		1	
16	999 152 004 00	Circlip		1	
17	911 201 593 00	Overflow socket		1	
18	901 201 931 00	Overflow hose		1	
18	911 201 731 00	Overflow hose		1	
19	911 201 141 00	Fuel filter		1	
20	911 201 143 00	Sealing ring		1	
21	911 608 102 00	Fuel pump	-79	1	
21	911 608 102 02	Fuel pump	80-	1	
22	999 512 394 00	Hose clamp		1	TURBO
23	911 608 105 01	Support		1	
24	911 608 206 00	Bonded rubber buffer		2	
25	999 072 005 09	Hexagon nut M 6 X 12		1	
25	999 072 005 01	Hexagon nut M 6 X 12		1	
26	N 010 208 5	Hexagon-head bolt M 6 X 8		1	
27	N 012 226 5	Spring washer B 6		1	
28	N 011 524 7	Washer A 6,4		1	
28	N 011 524 27	Washer A 6,4		1	
29	N 010 208 5	Hexagon-head bolt M 6 X 8		2	
30	N 012 226 5	Spring washer B 6		2	
-	999 181 168 50	Hose 12 X 18,5		*	
31		90 MM		1	
32	999 512 554 00	Hose clamp		2	
33	911 356 066 07	Pressure line Only together with 911.608.211.00 900.070.010.02 N 013.811.1		1	
33		Pressure line Only together with N 013.812.2 999.134.018.02	-79	1	SC
33		Pressure line		1	TURBO
33	911 356 066 08	Pressure line	80-	1	SC
-	999 134 018 02	Banjo bolt M 12 X 1,5		1	
34	N 013 812 2	Sealing ring A 12 X 15,5		1	
34A	911 608 211 00	Intermediate piece		1	
(34A)	893 906 093	Check valve		1	

Model: 911 78 Model life 1978>>1983

Pos	Part Number	Description	Remark	Qty	Model
35	900 123 144 30	Sealing ring A 10 X 13,5		2	
35	900 123 005 20	Sealing ring A 12 X 16		2	
35A	900 070 010 02	Cap nut M 10 X 1,25		1	
35A	928 110 475 01	Cap nut M 12 X 15,5		1	
35A	928 110 475 03	Cap nut M 12 X 15,5		1	
35A	928 110 475 04	Cap nut M 12 X 15,5		1	
36	911 356 202 03	Rubber sleeve		4	
37	999 613 017 40	Covering		*	
38	911 356 062 07	Return line	-79	1	SC
38		Return line		1	TURBO
38	911 356 062 08	Return line	80-	1	SC
39	999 511 100 02	Pipe clamp	-81	1	
39	999 511 093 02	Pipe clamp	82-	1	
40	900 187 104 02	Tapping screw B 4,8 X 13		1	

Model: 911 78

Model life 1978>>1983

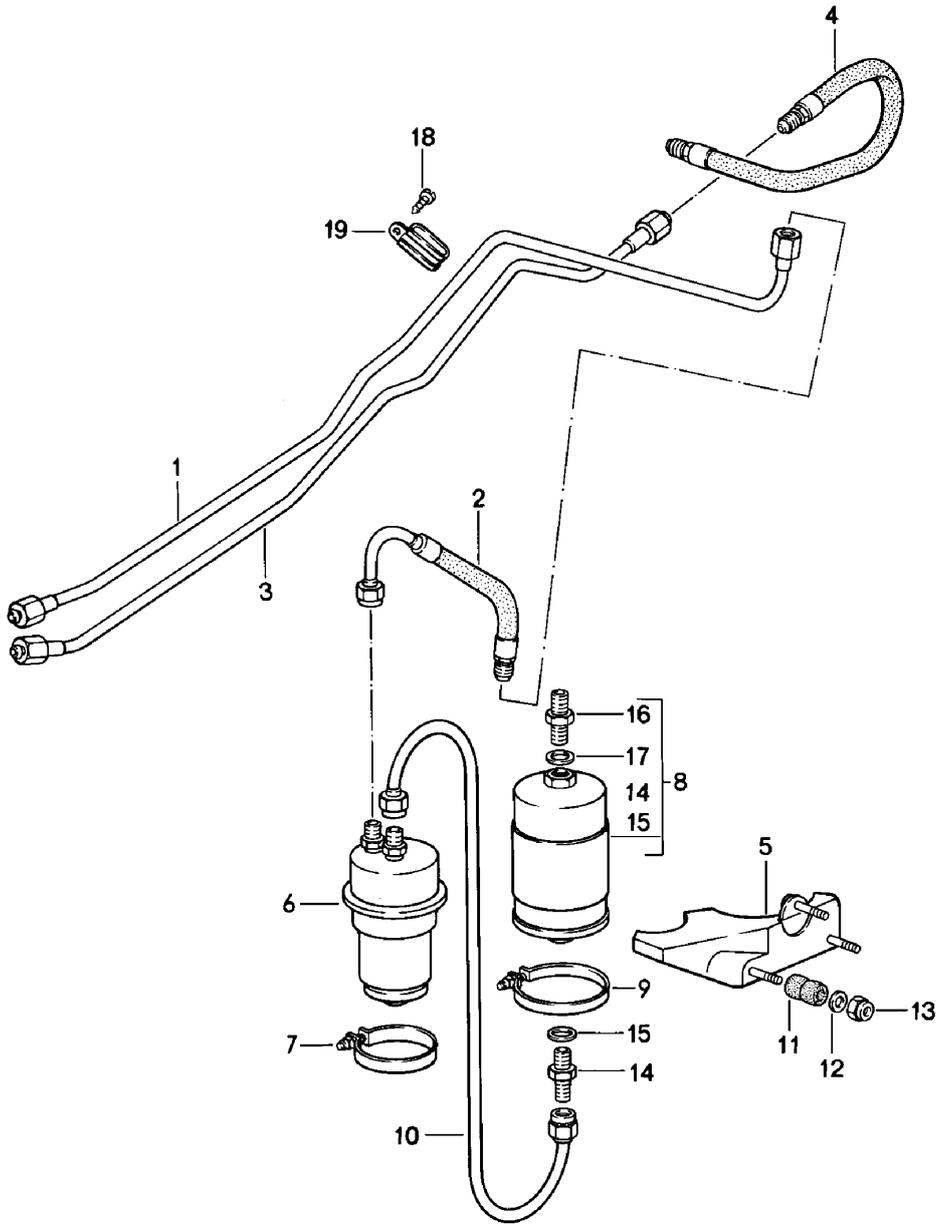

Model: 911 78

Model life 1978>>1983

Pos	Part Number	Description	Remark	Qty	Model
		Fuel system Rear			911SC
(1)	911 356 066 06	Pressure line	-79	1	
(1)	911 356 066 10	Pressure line		1	
1	911 356 083 00	Pressure line	80-	1	
2	911 356 087 00	Fuel hose	80-	1	
2	911 356 087 01	Fuel hose	80-	1	
(3)	911 356 062 05	Return line	-79	1	
3	911 356 085 00	Return line	80-	1	
4	911 356 089 01	Fuel hose	80-	1	
5	930 356 041 01	Bracket		1	
6	911 110 197 01	Fuel accumulator	-79	1	
6	911 110 197 02	Fuel accumulator	80-	1	
7	999 512 322 02	Hose clamp	-79	1	
7	999 512 199 02	Clamp	80-	1	
8	930 110 076 00	Fuel filter	-80	1	
8	930 110 076 02	Fuel filter		1	
8	928 110 147 05	Fuel filter	81-	1	
9	999 512 234 02	Hose clamp	-80	1	
9	999 512 235 02	Hose clamp		1	
(10)	930 356 083 00	Fuel line	-79	1	
10	911 356 091 00	Fuel line	80	1	
10	911 356 091 02	Fuel line	81-	1	
11	901 504 859 20	Hose piece		3	
12	999 025 108 02	Washer 6,4		3	
13	900 084 010 02	Lock nut		3	
13	900 910 012 02	Lock nut M 6		3	
13	900 910 047 09	Lock nut M 6		3	
14	930 110 198 00	Screw socket	-80	1	
15	900 123 007 30	Sealing ring	-80	1	
16	930 110 199 00	Screw socket	-80	1	
17	900 123 116 30	Sealing ring	-80	1	
18	900 187 104 02	Tapping screw B 4,8 X 13	-79	1	
19	999 511 093 02	Pipe clamp	-79	1	

Model: 911 78

Model life 1978>>1983

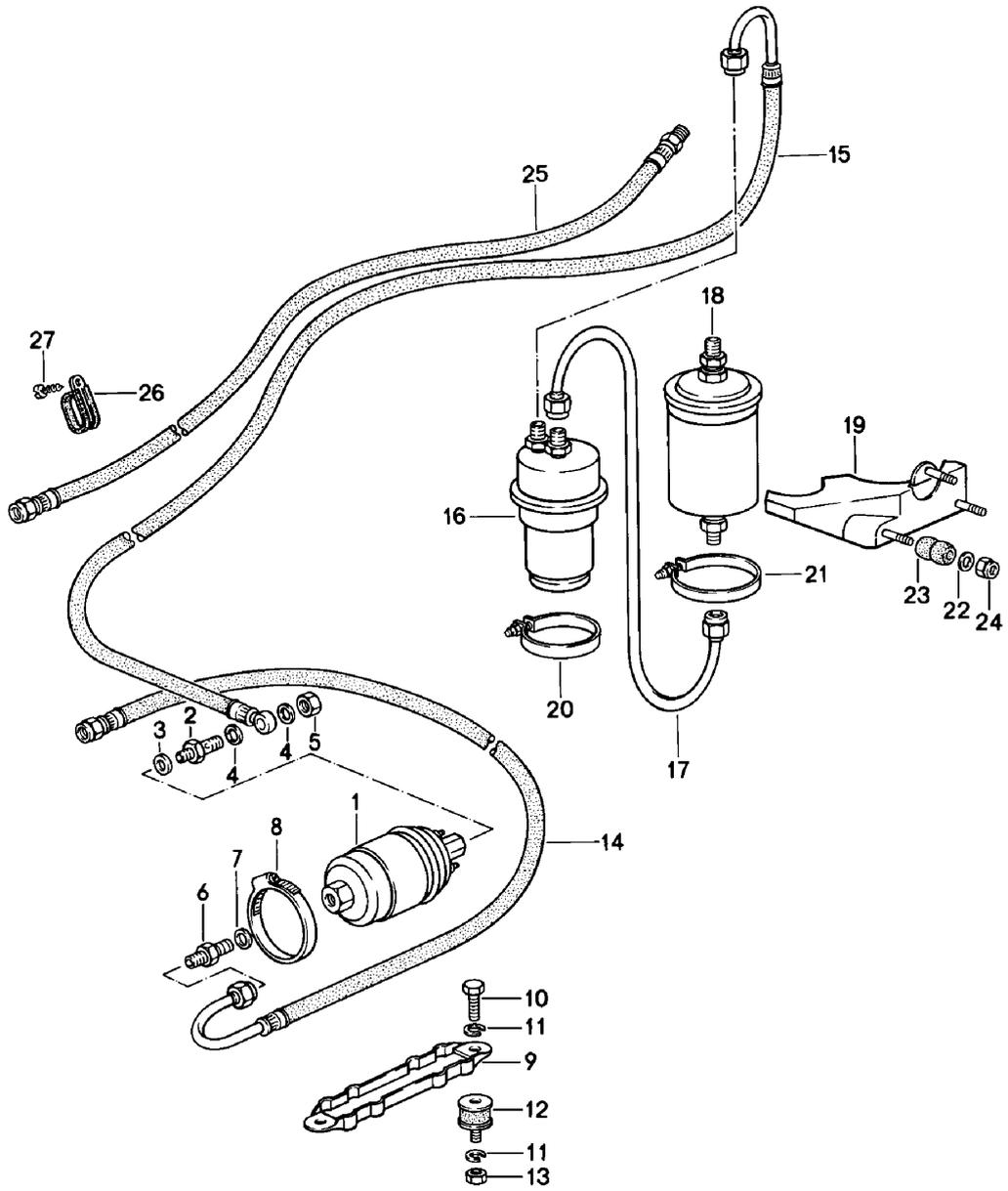

Model: 911 78 Model life 1978>>1983

Pos	Part Number	Description	Remark	Qty	Model
		Fuel system Rear			TURBO
1	930 608 113 00	Fuel pump		1	
2	911 608 211 00	Intermediate piece	-79	1	
3	900 123 043 30	Sealing ring	-79	1	
3	900 123 116 30	Sealing ring A 12 X 15,5	-79	1	
4	900 123 144 30	Sealing ring A 10 X 13,5	-79	2	
5	900 070 010 02	Cap nut	-79	1	
6	N 020 702 1	Screw socket		1	
7	900 123 007 30	Sealing ring		1	
7		Sealing ring A 14 X 18		1	
8	999 512 394 00	Hose clamp		1	
8		Hose clamp		1	
9	911 608 105 00	Support		1	
10	N 010 208 5	Hexagon-head bolt M 6 X 8		2	
11	N 012 007 2	Lock ring		4	
11	900 027 004 03	Lock ring		4	
11	N 012 007 2	Lock ring A 6		4	
11	900 027 004 03	Lock ring A 6		4	
12	999 703 384 00	Megulastik pivot bearing		2	
12	999 703 384 01	Megulastik pivot bearing		2	
13	900 076 010 02	Nut M 6		2	
13	900 076 010 0B	Nut M 6		2	
14	930 356 068 02	Fuel line		1	
15	930 356 081 02	Pressure line Only together with 911.608.211.00 900.070.010.02 900.123.033.20	-79	1	
15	930 356 081 04	Fuel line		1	
15	930 356 081 06	Fuel line		1	
15	930 356 081 04	Fuel line Only together with 900.123.043.20 999.134.018.02		1	
15	930 356 081 06	Fuel line Only together with 900.123.043.20 999.134.018.02		1	
-	999 134 018 02	Banjo bolt M 12 X 1,5		1	
16	911 110 197 02	Fuel accumulator		1	
16		Fuel accumulator		1	
17	930 356 083 00	Fuel line	-80	1	
17	911 356 091 02	Fuel line	81-	1	
18	930 110 139 00	Fuel filter	-80	1	
18	928 110 147 05	Fuel filter	81-	1	
19	930 356 041 01	Bracket	-79	1	
19		Bracket		1	
20	999 512 199 02	Clamp		1	
21	999 512 235 02	Hose clamp		1	
22	999 025 108 02	Washer 6,4		3	
23	901 504 859 20	Hose piece		3	
24	900 910 012 02	Lock nut		3	

Model: 911 78

Model life 1978>>1983

Pos	Part Number	Description	Remark	Qty	Model
24	900 910 047 09	M 6 Lock nut		3	
25	930 356 062 01	M 6 Return line		1	
-	999 513 010 40	Tie-wrap		1	
26	999 511 100 02	Pipe clamp	-81	1	
26	999 511 093 02	Pipe clamp	82-	1	
27	900 187 104 02	Tapping screw B 4,8 X 13		1	

Model: 911 78

Model life 1978>>1983

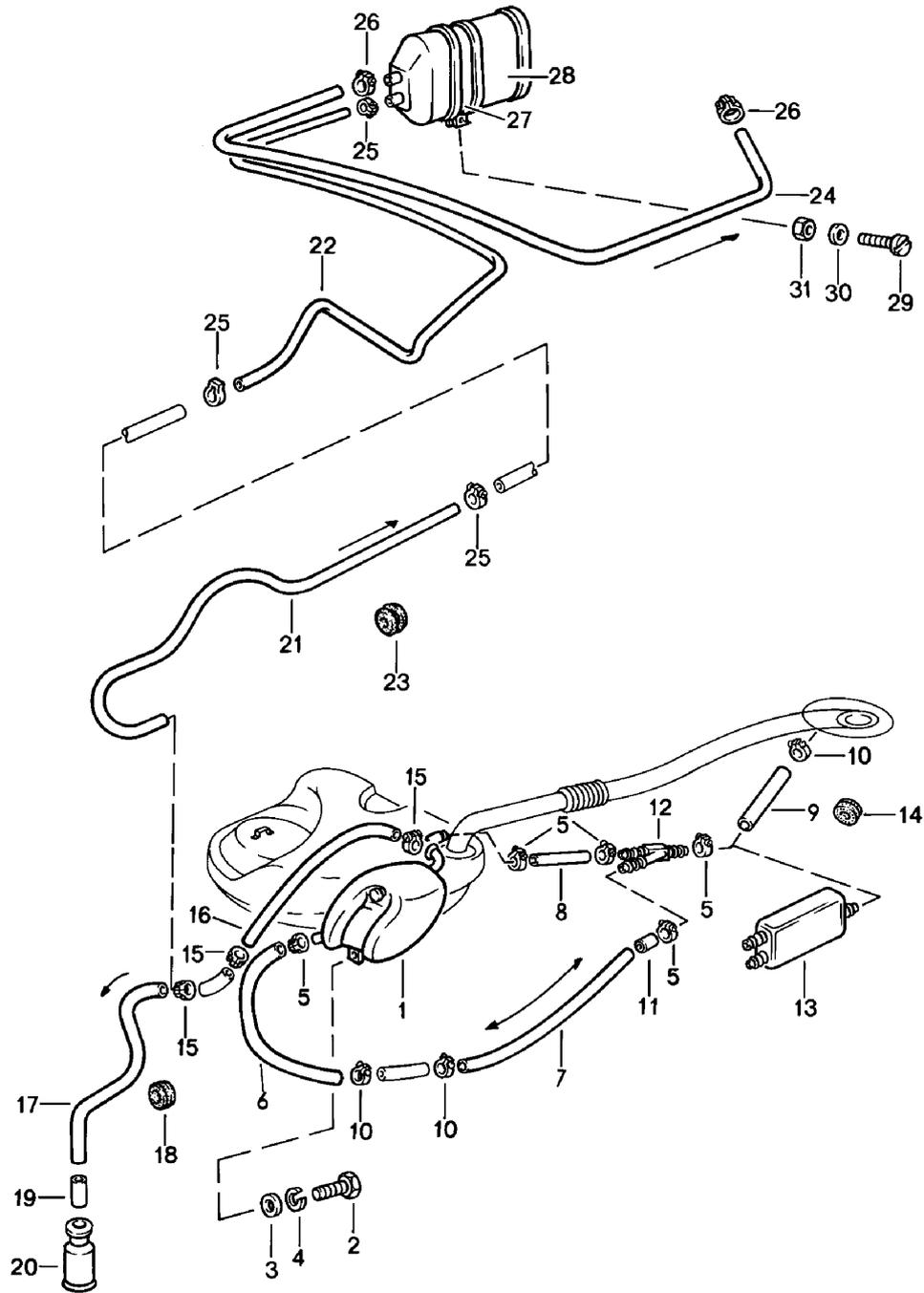

Model: 911 78 Model life 1978>>1983

Pos	Part Number	Description	Remark	Qty	Model
1	911 201 077 02	Tank ventilation Expansion tank		1	
1		Expansion tank		1	
2	900 075 057 02	Hexagon-head bolt M 6 X 16		1	
2	900 075 057 03	Hexagon-head bolt M 6 X 16		1	
3	N 011 524 7	Washer		1	
3	N 011 524 27	Washer		1	
3	N 011 524 7	Washer 6,4		1	
3	N 011 524 27	Washer 6,4		1	
4	N 012 007 02	Lock ring A 6		1	
5	N 023 570 2	Hose clamp		5	
5		Hose clamp S 15/9		5	
5	999 512 554 00	Hose clamp	80-	4	
-	N 020 359 1	Hose 9 X 2,5		*	
6		390 MM		1	
7		150 MM	-79	1	
7		250 MM	80-	1	
8		220 MM	-79	1	
9		270 MM	-79	1	
-	999 181 189 50	Hose 14 X 2,5		*	
-	999 181 189 5A	Hose 14 X 4 X 22		*	
8		140 MM	80	1	
8	911 201 915 00	Breather hose	81-	1	
9	911 201 287 01	Hose	80-	1	
10	999 512 160 02	Hose clamp S 13/9		3	
10	PCG 512 160 02	Hose clamp S 13/9		3	
11	911 201 263 02	Restrictor		1	
11		Restrictor		1	
12	911 201 171 02	Connecting piece	-79	1	
13	911 201 381 00	Expansion tank	80-	1	
-	999 513 003 40	Tie-wrap	80-	1	
14	999 702 085 50	Rubber sleeve		1	
15	999 512 069 02	Hose clamp S 8/7		3	
15	PCG 512 069 02	Hose clamp S 8/7		3	
-	N 020 361 2	Hose		*	
-		Hose 4 X 1,5		*	
16		370 MM		1	
17		1020 MM		1	
18	911 612 865 00	Rubber sleeve		1	
19	911 201 157 01	Sleeve		1	
20	999 659 015 40	Protection cap for (USA) (CDN) (J) (KALIFORNIEN) (AUS)		1	
-	N 020 361 2	Hose		*	
-		Hose 4 X 1,5		*	
21		1080 MM		1	

Model: 911 78

Model life 1978>>1983

Pos	Part Number	Description	Remark	Qty	Model
22		1980 MM		1	
23	999 702 084 50	Rubber sleeve		1	
23		Rubber sleeve		1	
-	N 020 362 1	Hose		*	
		12 X 2,5			
24		1750 MM		1	SC
24		750 MM		1	TURBO
25	999 512 069 02	Hose clamp		3	
25	PCG 512 069 02	Hose clamp		3	
26	999 512 265 02	Hose clamp		2	
		S 16/9			
27	911 501 425 00	Support		1	
	911 501 425 00 GRV	Prime coated			
28	113 201 801 B	Carbon canister		1	
28	171 201 801	Carbon canister		1	
28	171 201 801 C	Carbon canister		1	
28	1H0 201 801 C	Carbon canister		1	
29	900 014 028 02	Pan-head screw		1	
		AM 6 X 20			
30	N 011 524 7	Washer		1	
		6,4			
30	N 011 524 27	Washer		1	
		6,4			
31	900 910 011 02	Lock nut		1	
		M 6			

Model: 911 78

Model life 1978>>1983

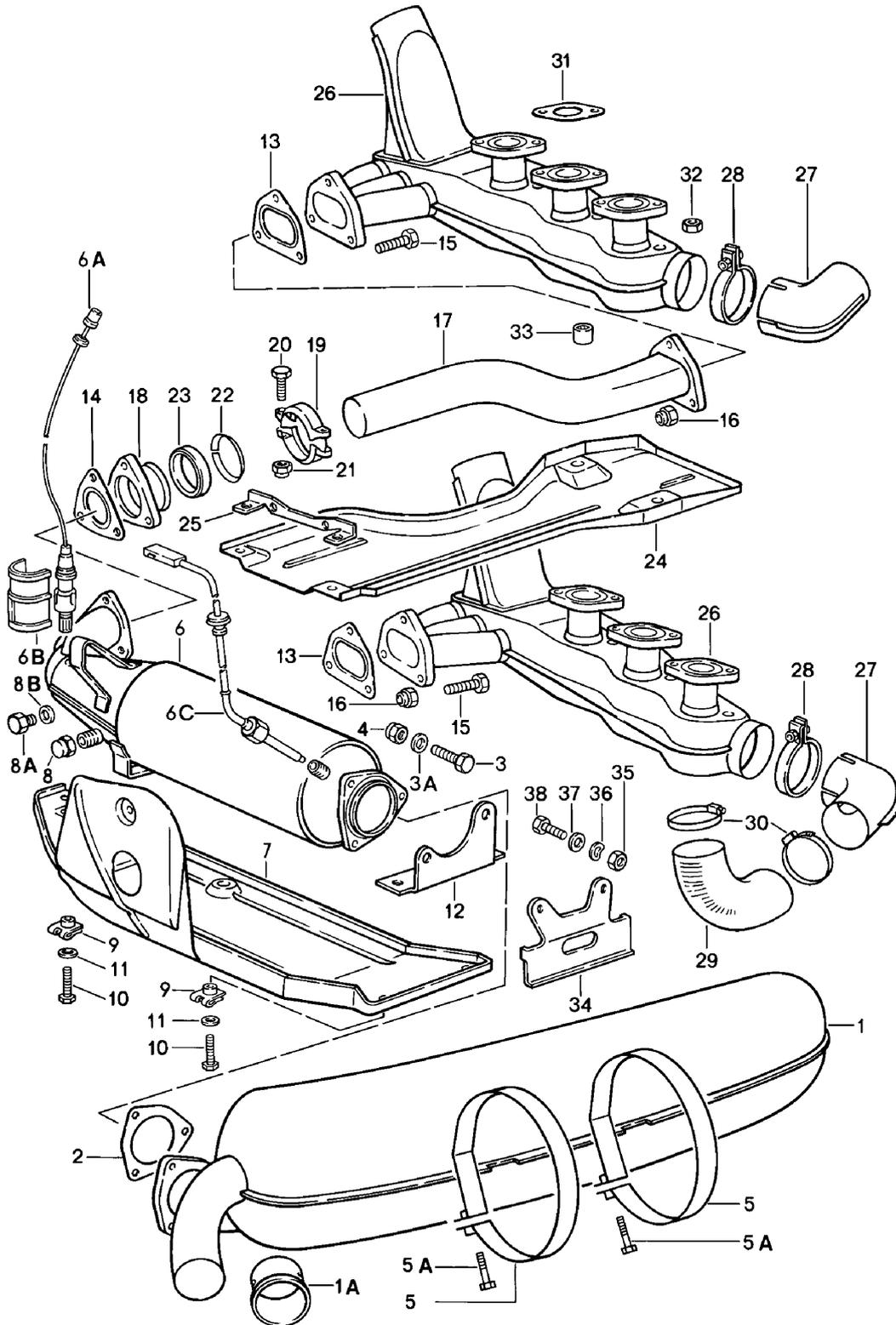

Model: 911 78

Model life 1978>>1983

Pos	Part Number	Description	Remark	Qty	Model
1	930 111 022 00	Exhaust system Exhaust silencer Not for (J)		1	911 SC
1	930 111 022 03	Exhaust silencer Not for (J)		1	
1A	911 111 245 00	Ornamental exhaust pipe		1	
1A	911 111 245 02	Ornamental exhaust pipe Black		1	
1A	911 111 245 03	Ornamental exhaust pipe Chrome		1	
2	911 111 191 01	Gasket		1	
2	911 111 191 02	Gasket		1	
3	900 074 282 02	Screw M 8 X 40		3	
3A	900 151 008 02	Washer 8,4		1	
4	900 910 097 02	Lock nut		3	
5	901 111 157 04	Clamp		2	
5A	900 067 161 02	Pan-head screw M 10 X 50		2	
6	930 111 183 03	Front muffler		1	
6		Front muffler		1	
6		Front muffler		1	
13	930 111 192 01	Gasket		2	
13	930 111 192 03	Gasket		2	
13	930 111 192 04	Gasket		2	
13	930 111 192 06	Gasket		2	
14	930 111 193 01	Gasket		1	
14	930 111 193 04	Gasket		1	
14	930 111 193 05	Gasket		1	
14	930 111 193 07	Gasket		1	
15	900 074 282 02	Screw M 8 X 40		6	
16	900 910 097 02	Lock nut		6	
17	930 111 169 05	Exhaust line		1	
17		Exhaust line		1	
18	930 111 157 01	Compensating socket		1	
19	911 111 187 00	Clamp		2	
20	900 074 267 02	Hexagon-head bolt M 6 X 40		2	
21	900 910 096 02	Lock nut		2	
22	911 111 188 02	Support washer		1	
23	911 111 189 03	Gasket		1	
26	930 211 025 01	Heat exchanger		2	
27	911 211 131 00	Adapter		2	
28	999 512 246 02	Clamp SP 68/20		2	
28	999 512 246 0C	Clamp SP 68/20		2	
-	999 075 057 0B	Hexagon-head bolt M 8 X 35		X	
-	999 075 057 02	Hexagon-head bolt M 6 X 16		X	
29	911 211 553 00	Flexible pipe		1	
30	999 512 349 02	Hose clamp		2	
30	999 512 349 01	Hose clamp		2	
30	999 512 349 0B	Hose clamp		2	
31	930 111 191 13	Gasket		6	
32	900 076 025 02	Hexagon nut M 8		6	
32	900 076 064 02	Hexagon nut		6	

Model: 911 78

Model life 1978>>1983

Pos	Part Number	Description	Remark	Qty	Model
33	999 085 001 02	M 8 Socket head nut		6	
34	901 111 151 04	M 8 Bracket		1	
35	900 076 025 02	Hexagon nut M 8		2	
35	900 076 064 02	Hexagon nut M 8		2	
36	N 012 241 8	Spring washer B 8		2	
37	900 025 007 02	Washer 8,4		2	
37	900 025 007 03	Washer 8,4		2	
38	900 075 087 02	Hexagon-head bolt M 8 X 16		2	
38	900 075 087 03	Hexagon-head bolt M 8 X 16		2	

Model: 911 78

Model life 1978>>1983

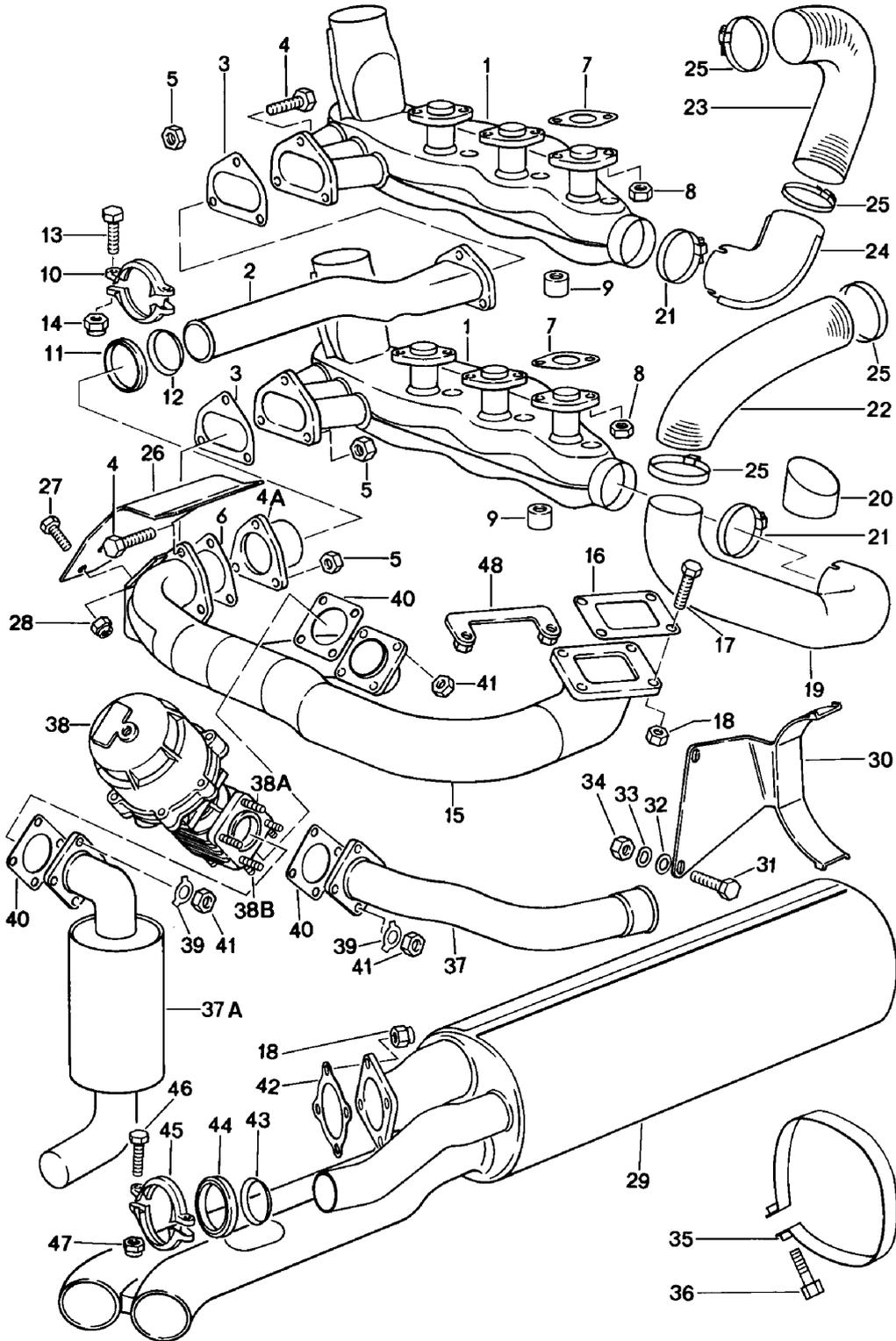

Model: 911 78 Model life 1978>>1983

Pos	Part Number	Description	Remark	Qty	Model
		Exhaust system			TURBO 930.60/66
1	930 211 021 03	Heat exchanger		2	
2	930 111 163 04	Exhaust line		1	
3	930 111 192 01	Gasket		2	
4	900 074 282 02	Screw M 8 X 37		6	
4A	930 111 157 00	Compensating socket		1	
5	900 910 097 02	Lock nut M 8		9	
6	930 111 193 01	Gasket		1	
6	930 111 193 04	Gasket		1	
6	930 111 193 05	Gasket		1	
6	930 111 193 07	Gasket		1	
7	930 111 191 01	Gasket		6	
8	900 910 097 02	Lock nut M 8		6	
9	999 085 001 02	Socket head nut M 8		6	
10	930 111 187 00	Clamp		2	
11	911 111 189 03	Gasket		1	
12	930 111 156 01	Support washer		1	
13	900 074 283 02	Screw M 8 X 45		2	
14	900 910 097 02	Lock nut M 8		2	
15	930 111 003 04	Exhaust line		1	
16	930 123 192 01	Gasket		1	
17	900 074 284 02	Screw M 10 X 40		4	
18	900 910 099 02	Lock nut M 10		6	
19	930 211 123 00	Hot air line		1	
20	930 211 197 00	Hose		1	
21	999 512 246 02	Clamp		2	
21	999 512 246 0C	Clamp		2	
-	999 075 057 0B	Hexagon-head bolt M 8 X 35		X	
-	999 075 057 02	Hexagon-head bolt M 6 X 16		X	
22	930 211 196 00	Heater hose	/L	1	
22	930 211 196 01	Heater hose	/L	1	
23	901 211 194 00	Heater hose	/R	1	
23	901 211 194 01	Heater hose	/R	1	
24	911 211 131 00	Adapter		1	
25	999 512 349 02	Hose clamp		4	
25	999 512 349 01	Hose clamp		4	
25	999 512 349 0B	Hose clamp		4	
26	930 111 128 03	Heat shield		1	
27	900 075 303 02	Hexagon-head bolt M 6 X 16		2	
28	900 910 096 02	Lock nut M 6		2	
29	930 111 037 00	Exhaust silencer	-79	1	
29	930 111 037 04	Exhaust silencer		1	
(29)	930 111 038 06	Exhaust silencer	83-	1	
30	930 111 154 03	Bracket		1	
30	930 111 154 02	Bracket		1	M559
31	900 075 313 02	Hexagon-head bolt M 10 X 20		2	
32	900 025 008 02	Washer		2	
32	900 025 008 09	Washer 10,5		2	

Model: 911 78

Model life 1978>>1983

Pos	Part Number	Description	Remark	Qty	Model
32	900 025 008 04	Washer 10,5		2	
33	900 028 005 02	Spring washer		2	
33	900 028 005 00	Spring washer A 10		2	
34	900 910 098 02	Lock nut M 10		2	
35	930 111 155 00	Clamp		1	
36	900 067 161 02	Pan-head screw AM 10 X 50		1	
36	900 067 225 02	Pan-head screw M 10X55		1	
37	930 123 031 00	Wastegate line	-82	1	
37A	930 123 063 01	Muffler	83-	1	
38	930 123 060 12	Wastegate		1	
38A	900 081 048 02	Stud		4	
38A		Stud M 8 X 25		4	
38B	900 081 049 02	Stud		4	
38B		Stud M 8 X 32		4	
39	999 039 001 00	Tab washer		4	
40	930 123 194 01	Gasket		2	
41	900 910 097 02	Lock nut M 8		8	
42	930 123 191 01	Gasket		2	
43	930 123 132 02	Support washer	-82	1	
44	930 123 134 04	Gasket	-82	1	
45	930 123 133 00	Clamp	-82	2	
46	900 074 286 02	Hexagon-head bolt BM 6 X 40	-82	2	
47	900 910 096 02	Lock nut M 6	-82	2	
48	930 123 114 02	Supporting plate		1	

Model: 911 78

Model life 1978>>1983

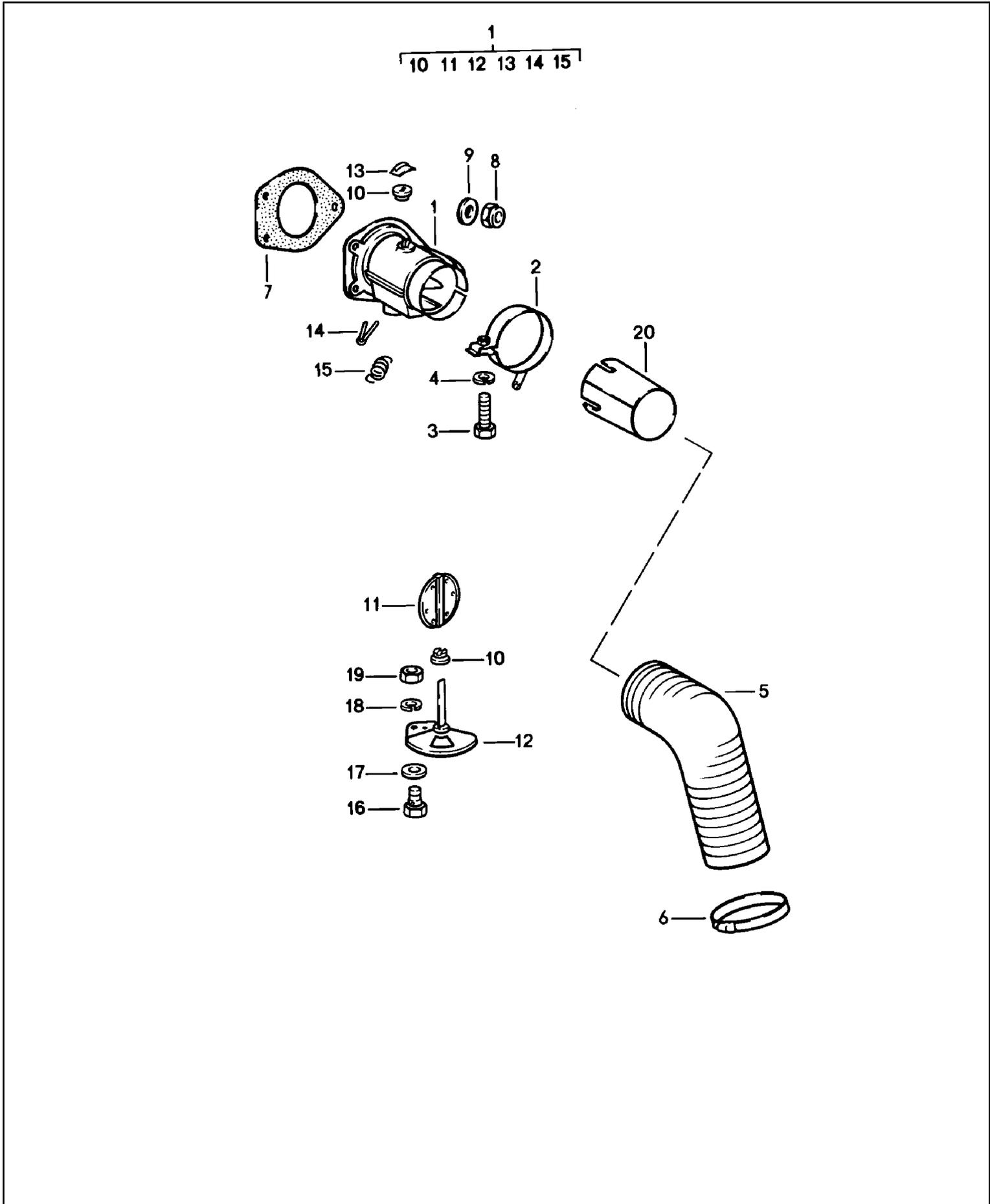

Model: 911 78

Model life 1978>>1983

Pos	Part Number	Description	Remark	Qty	Model
1	901 211 007 22	Heating air supply Heat control box Black	/L	1	
1	901 211 007 23	Heat control box Red	/L	1	
(1)	901 211 008 22	Heat control box Black	/R	1	
(1)	901 211 008 23	Heat control box Red	/R	1	
2	901 211 051 21	Pipe clamp	/L	1	
2	901 211 051 22	Pipe clamp	/L	1	
(2)	901 211 052 21	Pipe clamp	/R	1	
(2)	901 211 052 22	Pipe clamp	/R	1	
3	N 010 217 9	Hexagon-head bolt M 6 X 20		2	
4	900 027 014 01	Lock ring		2	
4	N 012 006 4	Lock ring B 6		2	
5	911 211 622 00	Connecting hose		2	
5	930 211 622 01	Connecting hose 300 MM Long		2	
5		Connecting hose 330 MM Long		1	
5		Connecting hose 330 MM Long		2	
6	999 512 349 02	Hose clamp		2	
6	999 512 349 01	Hose clamp		2	
6	999 512 349 0B	Hose clamp		2	
7	911 211 297 00	Gasket		2	
8	900 084 010 02	Lock nut		6	
8	900 910 012 02	Lock nut M 6		6	
8	900 910 047 09	Lock nut M 6		6	
9	N 011 524 7	Washer 6,4		6	
9	N 011 524 27	Washer 6,4		6	
10	901 211 255 21	Bearing		4	
11	901 211 028 22	Air flap		2	
12	901 211 035 21	Rotary slide	/L	1	
(12)	901 211 036 21	Rotary slide	/R	1	
13	999 507 222 02	Mecano-speed-fix		2	
14	900 021 014 02	Cotter pin		2	
14	N 012 530 1	Cotter pin 3 X 15		2	
15	999 522 013 01	Spring		2	
16	901 211 683 00	Clamping screw		2	
17	999 025 042 02	Washer		4	
18	900 027 011 01	Lock ring B 4		2	
19	N 011 004 6	Hexagon nut M 4		2	
19	N 011 004 G	Nut M 4		2	
20	911 659 119 00	Connecting piece for Caloric feeler		1	M424

Model: 911 78

Model life 1978>>1983

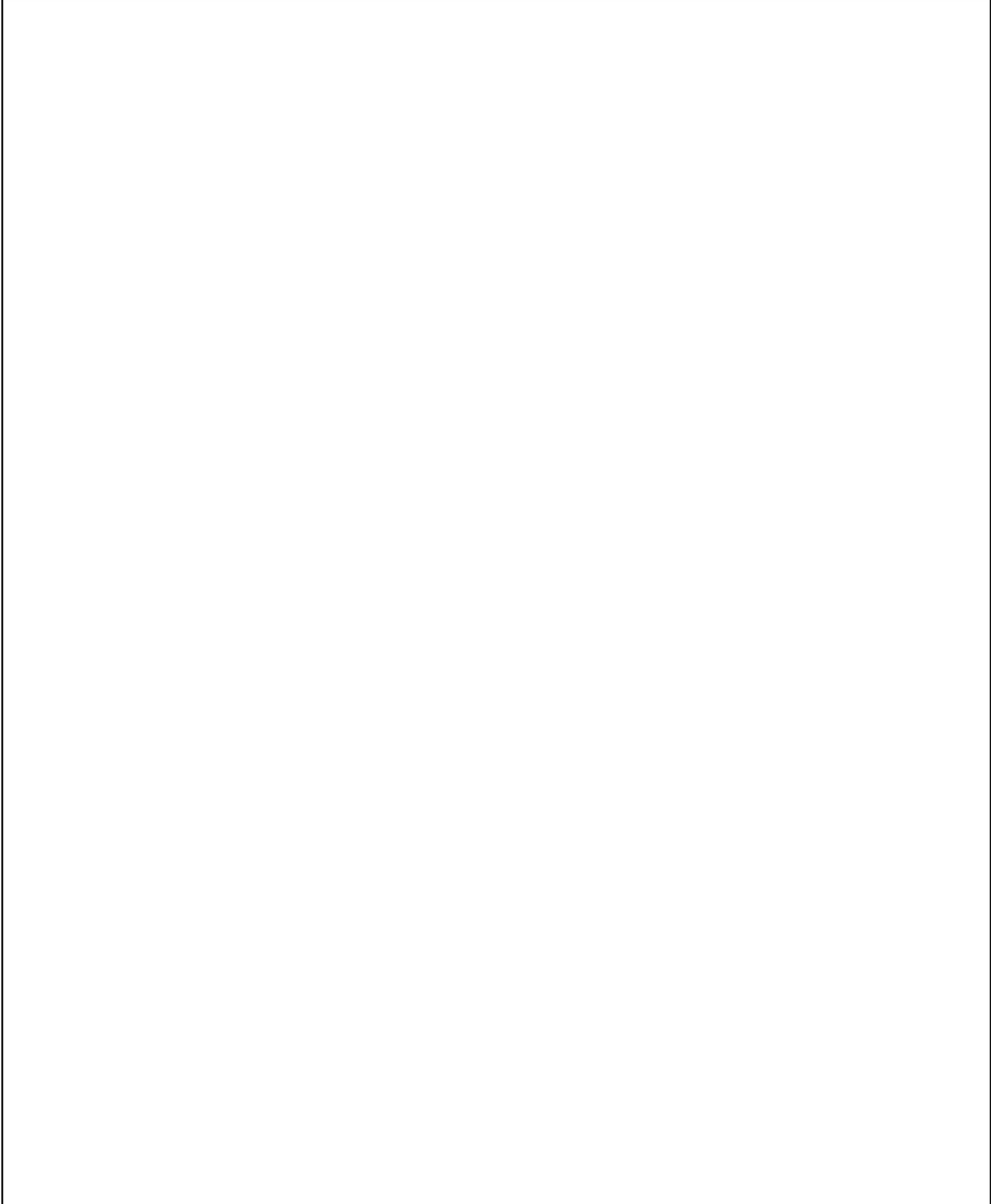

Model: 911 78

Model life 1978>>1983

Pos	Part Number	Description	Remark	Qty	Model
1	PCG 911 211 00	Maintenance set Repair kit Assembly kit Heat exchanger Comprising:	74-86	1	CARRERA
-	930 111 191 13	Gasket		6	
-	900 076 064 02	Hexagon nut		6	
-	999 085 001 02	Socket head nut		6	
-	900 074 282 02	Screw		9	
-	900 910 097 0C	Lock nut		9	
-	930 111 192 06	Gasket		2	
-	911 111 189 03	Gasket		1	
-	911 111 188 02	Support washer		1	
-	911 111 187 00	Clamp		2	
-	900 074 378 01	Screw		2	
-	900 074 233 02	Screw		2	
-	900 910 096 02	Lock nut		2	
2	PCG 930 211 00	Assembly kit Heat exchanger Comprising:	78-89	1	Turbo
-	900 067 161 02	Pan-head screw		1	
-	900 074 282 02	Screw		9	
-	999 085 001 02	Socket head nut		6	
-	930 111 155 00	Clamp		1	
-	911 113 190 01	Gasket		6	
-	930 123 114 02	Supporting plate		1	
-	930 123 192 05	Gasket		1	
-	930 123 191 05	Sealing ring		2	
-	930 123 194 06	Gasket		2	
-	900 910 097 0C	Lock nut		25	
-	900 910 099 02	Lock nut		6	
-	930 107 123 01	Gasket		1	
-	999 084 052 02	Lock nut		4	
-	930 107 116 01	Gasket		1	
-	N 012 241 8	Spring washer		2	
-	999 701 473 40	Round seal		1	
-	930 111 193 07	Gasket		1	
-	930 111 192 06	Gasket		2	
-	930 111 187 00	Clamp		2	
-	911 111 189 03	Gasket		1	
-	930 111 156 01	Support washer		1	
-	900 074 283 02	Screw		2	
-	900 910 097 0C	Lock nut		2	
-	900 074 284 02	Screw		4	
-	930 111 187 00	Clamp		2	
-	900 910 096 02	Lock nut		2	
-	999 039 001 00	Tab washer		8	
-	900 123 043 30	Sealing ring		4	

Model: 911 78

Model life 1978>>1983

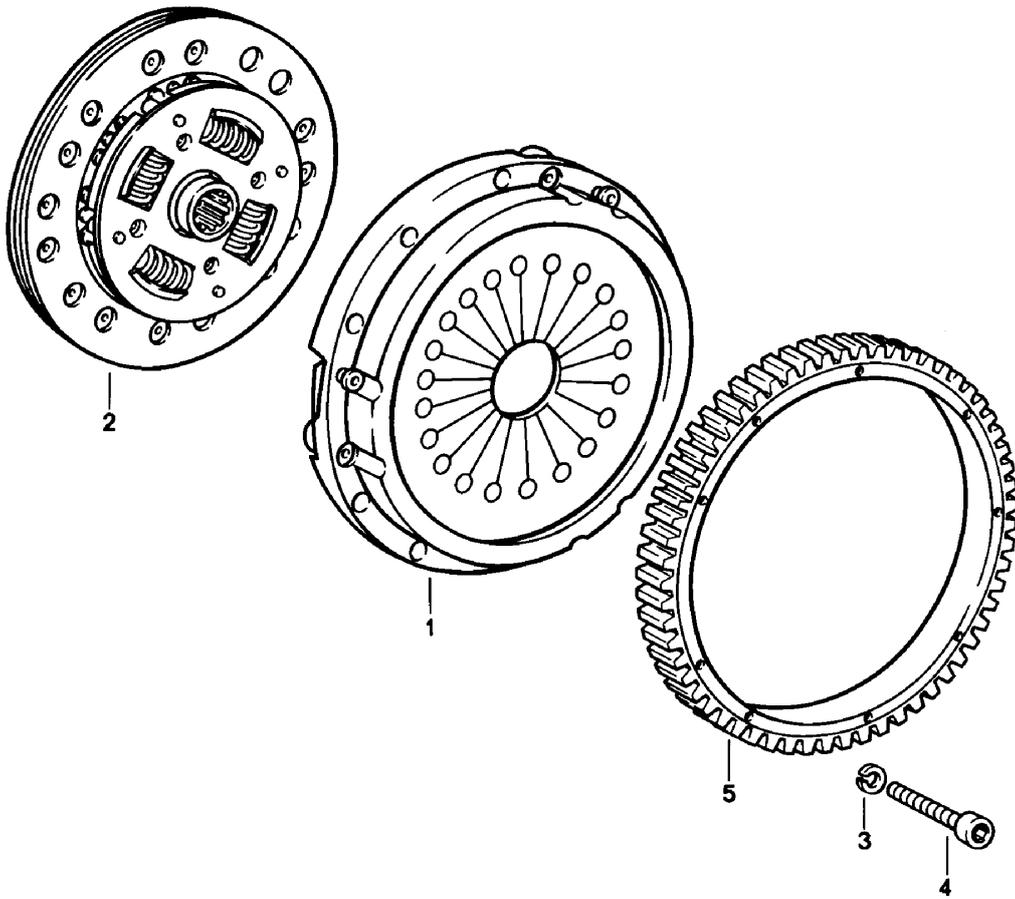

Model: 911 78 Model life 1978>>1983

Pos	Part Number	Description	Remark	Qty	Model
1	915 116 001 27	Clutch Pressure plate		1	SC
1	930 116 021 03	Pressure plate		1	TURBO
2	915 116 051 10	Clutch plate		1	SC
2	915 116 011 19	Clutch plate		1	SC
2	915 116 011 22	Clutch plate		1	SC
2	930 116 049 14	Clutch plate		1	TURBO
2	950 116 012 50	Clutch plate		1	TURBO
2	950 116 012 51	Clutch plate		1	TURBO
2	950 116 012 53	Drive plate		1	TURBO
2	950 116 012 54	Drive plate		1	TURBO
3	900 027 015 02	Lock ring B 8		9	SC
3	900 027 015 03	Lock ring B 8		9	SC
3	N 012 241 8	Spring washer B 8		9	TURBO
4	900 067 090 02	Pan-head screw M 8 X 42		9	SC
4	900 074 136 02	Hexagon-head bolt M 8 X 80		9	TURBO
4	900 074 136 03	Hexagon-head bolt M 8 X 80		9	TURBO
5	911 116 239 00	Starter ring		1	SC
5	911 116 239 04	Starter ring		1	SC
5	930 116 230 02	Starter ring		1	TURBO
5	930 116 230 03	Starter ring		1	TURBO
-	915 116 911 00	Repair kit for Clutch Comprising: Pressure plate Clutch plate Clutch release bearing		1	SC
-	930 116 911 00	Repair kit for Clutch Comprising: Pressure plate Clutch plate Clutch release bearing		1	TURBO
-	930 116 911 01	Repair kit for Clutch Comprising: Pressure plate Clutch plate Clutch release bearing		1	TURBO

Model: 911 78

Model life 1978>>1983

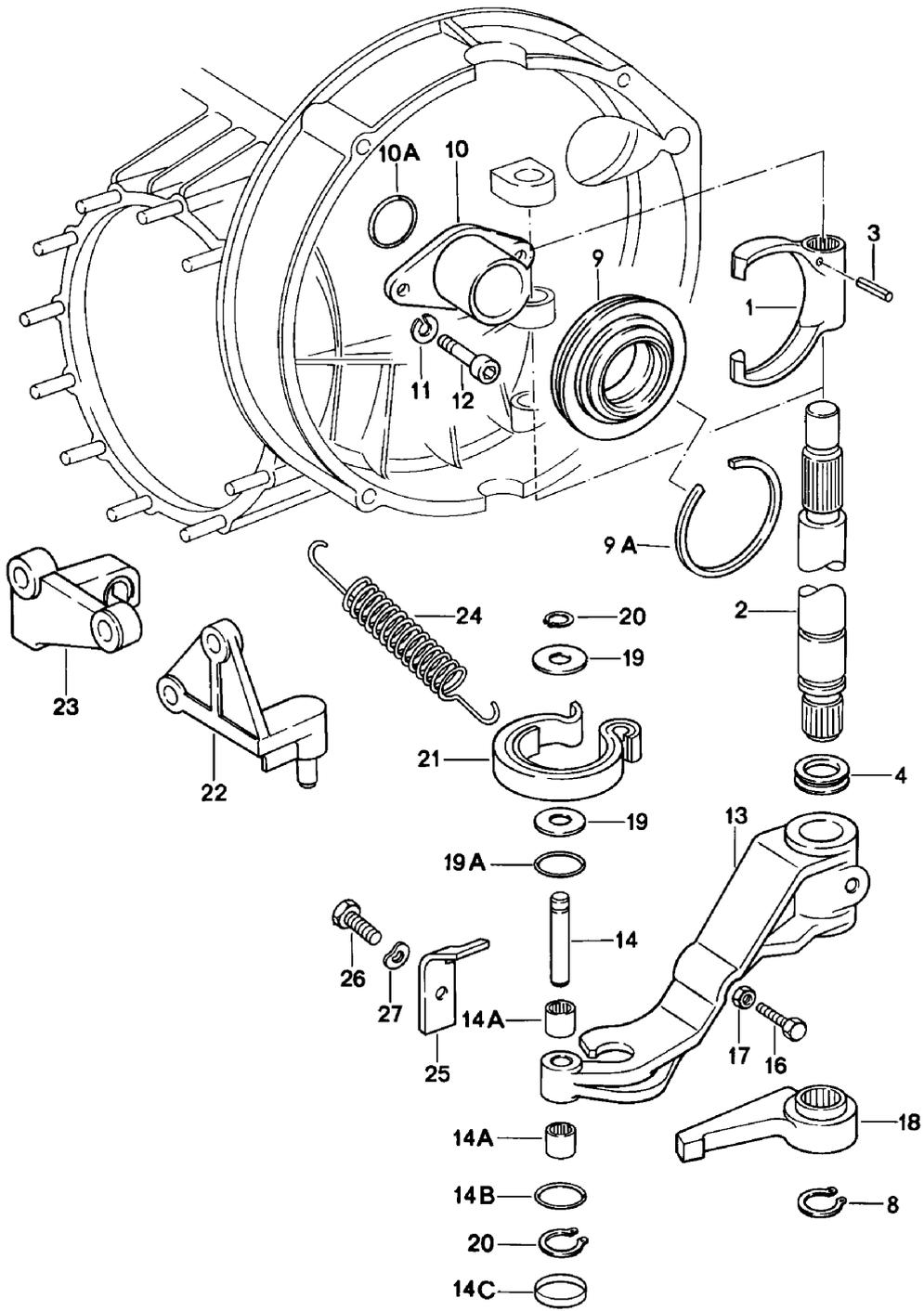

Model: 911 78

Model life 1978>>1983

Pos	Part Number	Description	Remark	Qty	Model
1	915 116 712 01	Clutch release Release fork		1	SC
1	915 116 712 03	Release fork		1	SC
(1)	930 116 712 02	Release fork		1	TURBO
2	915 116 133 05	Bellcrank		1	SC
(2)	930 116 133 04	Bellcrank		1	TURBO
3	900 095 050 00	Roll pin		1	
4	915 301 139 00	Sealing ring		3	SC
4	930 301 139 00	Sealing ring		2	TURBO
(4)	930 301 140 00	Sealing ring		2	TURBO
8	N 012 418 1	Circlip 18 X 1,2		1	
9	915 116 082 80	Clutch release bearing		1	SC
(9)	930 116 081 11	Clutch release bearing		1	TURBO
9A	999 152 073 01	Circlip SW 50		1	SC
10	930 116 813 00	Guide tube		1	TURBO
(10)	915 116 087 03	Guide tube		1	SC
(10)	915 116 087 06	Guide tube		1	SC
10A	999 701 359 40	O-ring 40 X 1,5		1	SC
11	N 012 006 4	Lock ring B 6		2	TURBO
12	900 186 032 02	Pan-head screw M 6 X 16		2	TURBO
(12)	900 270 055 02	Rais. counters. h. tap. s.		2	SC
(12)	999 270 070 01	Oval-head screw		2	SC
(12)	900 270 055 02	Rais. counters. h. tap. s. M 6 X 14		2	SC
(12)	999 270 070 01	Oval-head screw M 6 X 14		2	SC
(13)	930 116 713 06	Clutch release lever		1	TURBO
13	915 116 713 06	Clutch release lever		1	SC
13	915 116 713 08	Clutch release lever		1	SC
14	915 116 624 00	Bolt		1	SC
14A	999 201 212 00	Needle sleeve		2	SC
14B	900 234 502 01	Support washer		1	SC
14C	900 036 016 02	Lid		1	SC
16	930 116 701 00	Adjusting screw		1	SC
16	900 075 033 02	Stud		1	TURBO
16	900 075 033 03	Stud		1	TURBO
16	900 075 033 02	Stud M 8 X 40		1	TURBO
16	900 075 033 03	Stud M 8 X 40		1	TURBO
17	N 011 118 11	Hexagon nut		1	
17	900 034 001 05	Hexagon nut		1	
17	N 011 118 11	Hexagon nut M 8		1	
17	900 034 001 05	Hexagon nut M 8		1	
18	915 116 717 00	Change lever		1	SC
18		Change lever		1	SC
(18)	930 116 717 02	Change lever		1	TURBO
19	930 116 617 00	Washer		1	SC
19A	999 701 209 40	O-ring		1	SC
20	N 012 408 2	Circlip 8 X 0,8		2	SC
21	915 116 064 01	Spring		1	SC
(21)	930 116 064 09	Spring		1	TURBO
(21)	930 116 064 11	Spring		1	TURBO
22	915 116 070 00	Bearing bracket		1	SC
22	915 116 070 02	Bearing bracket		1	SC

Model: 911 78

Model life 1978>>1983

Pos	Part Number	Description	Remark	Qty	Model
(22)	930 116 611 06	Bearing bracket		1	TURBO
23	915 116 613 01	Support		1	SC
23		Support		1	SC
24	915 116 614 02	Tension spring		1	
25	930 116 714 06	Spring hanger		1	TURBO
26	900 075 087 02	Hexagon-head bolt		1	TURBO
26	900 075 087 03	Hexagon-head bolt		1	TURBO
26	900 075 087 02	Hexagon-head bolt M 8 X 16		1	TURBO
26	900 075 087 03	Hexagon-head bolt M 8 X 16		1	TURBO
27	N 012 241 8	Spring washer B 8		1	TURBO
-	999 701 482 40	O-ring		2	TURBO

Model: 911 78 Model life 1978>>1983

Pos	Part Number	Description	Remark	Qty	Model
-	915 300 010 61	Replacement transmission Transmission case Replacement transmission Ready for installation 5. Speed	-79	1	G 915/61
-	915 300 913 61	Manual transmission Ready for installation Limited-slip differential 5. Speed	-79	1	G 915/61.12
-	915 300 010 62	Manual transmission Ready for installation 5. Speed	80-	1	G 915/62
-	915 300 913 62	Manual transmission Ready for installation Limited-slip differential 5. Speed	80-	1	G 915/62.12
-	930 300 010 34	Manual transmission Ready for installation 4. Speed		1	G 930/34
-	930 300 010 35	Manual transmission Ready for installation 4. Speed	83- (CH)	1	G 930/35
-	930 300 911 34	Manual transmission Ready for installation Limited-slip differential 4. Speed		1	G 930/34.12
-	930 300 911 35	Manual transmission Ready for installation Limited-slip differential 4. Speed	83- (CH)	1	G 930/35.12
1	915 301 901 04	Transmission case		1	SC
1A	930 301 901 02	Transmission case		1	TURBO
2	999 062 139 02	Stud		16	
2		Stud		16	
2	999 062 009 02	Stud		8	TURBO
2	900 060 105 01	Stud		8	TURBO
2	999 062 009 02	Stud		8	TURBO
2	900 060 105 01	Stud		8	TURBO
(2)	999 062 098 02	Stud		4	SC
(2)		Stud		4	SC
3	999 062 006 02	Stud		6	TURBO
3		Stud		6	TURBO
(3)	999 062 008 02	Stud		4	TURBO
(3)		Stud		4	TURBO
(3)	900 061 057 02	Stud		10	SC
(3)	999 062 073 02	Stud		10	SC
-	930 301 141 00	Bolt		1	TURBO
-	900 061 057 02	Stud		1	TURBO

Model: 911 78 Model life 1978>>1983

Pos	Part Number	Description	Remark	Qty	Model
-	999 062 057 02	BM 8 X 15 Stud		1	TURBO
-	999 062 073 02	BM 8 X 15 Stud		1	TURBO
4	999 062 182 02	BM 8 X 15 Stud		1	
4		Stud		1	
5	900 012 110 00	M 10 X 25 Straight pin		2	
6	915 301 119 00	10 M 6 X 14 Bearing sleeve		1	
7	915 301 129 00	Bush		2	SC
7	915 301 129 01	Bush		2	SC
7	999 531 010 00	Bush		2	TURBO
8	915 301 133 00	Pipe		1	SC
9	999 504 047 00	Threaded insert		3	
10	999 113 183 40	Radial shaft seal		2	
11	915 302 381 00	Shaft sealing ring	-80	1	SC
11	999 113 327 40	Shaft sealing ring		1	SC
12	999 041 327 01	Circlip		1	SC
13	999 064 020 02	SB 62 Screw plug with magnet M 24 X 1,5		1	
14	904 301 071 00	Bleeder		1	
15	915 301 311 05	Transmission cover		1	SC
(15)	930 301 311 02	Transmission cover		1	TURBO
16	999 701 392 40	O-ring		1	SC
16	999 701 437 40	O-ring		1	TURBO
(17)	N 012 241 8	Spring washer		12	
18	900 076 025 02	B 8 Hexagon nut		12	
18	900 076 064 02	M 8 Hexagon nut		12	
19	915 303 232 00	M 8 Spring		2	
20	900 075 352 02	Spring		2	
20		Hexagon-head bolt		2	
20		Hexagon-head bolt		2	
21	900 123 066 30	Sealing ring		2	SC
21		Sealing ring		2	SC
22	915 303 131 00	A 10 X 16 Detent		4	
22A	930 303 131 00	Detent		2	
23	915 301 126 00	Locking bolt		1	SC
23A	999 501 028 30	Stopper		1	TURBO
24	900 308 026 00	Roll pin		2	TURBO
25	930 301 133 00	3,5 X 22 Guide ring		1	TURBO
26	930 302 332 00	Shaft sealing ring		1	TURBO
27	930 302 053 00	Pipe		1	TURBO
28	999 701 440 40	O-ring		1	TURBO

Model: 911 78

Model life 1978>>1983

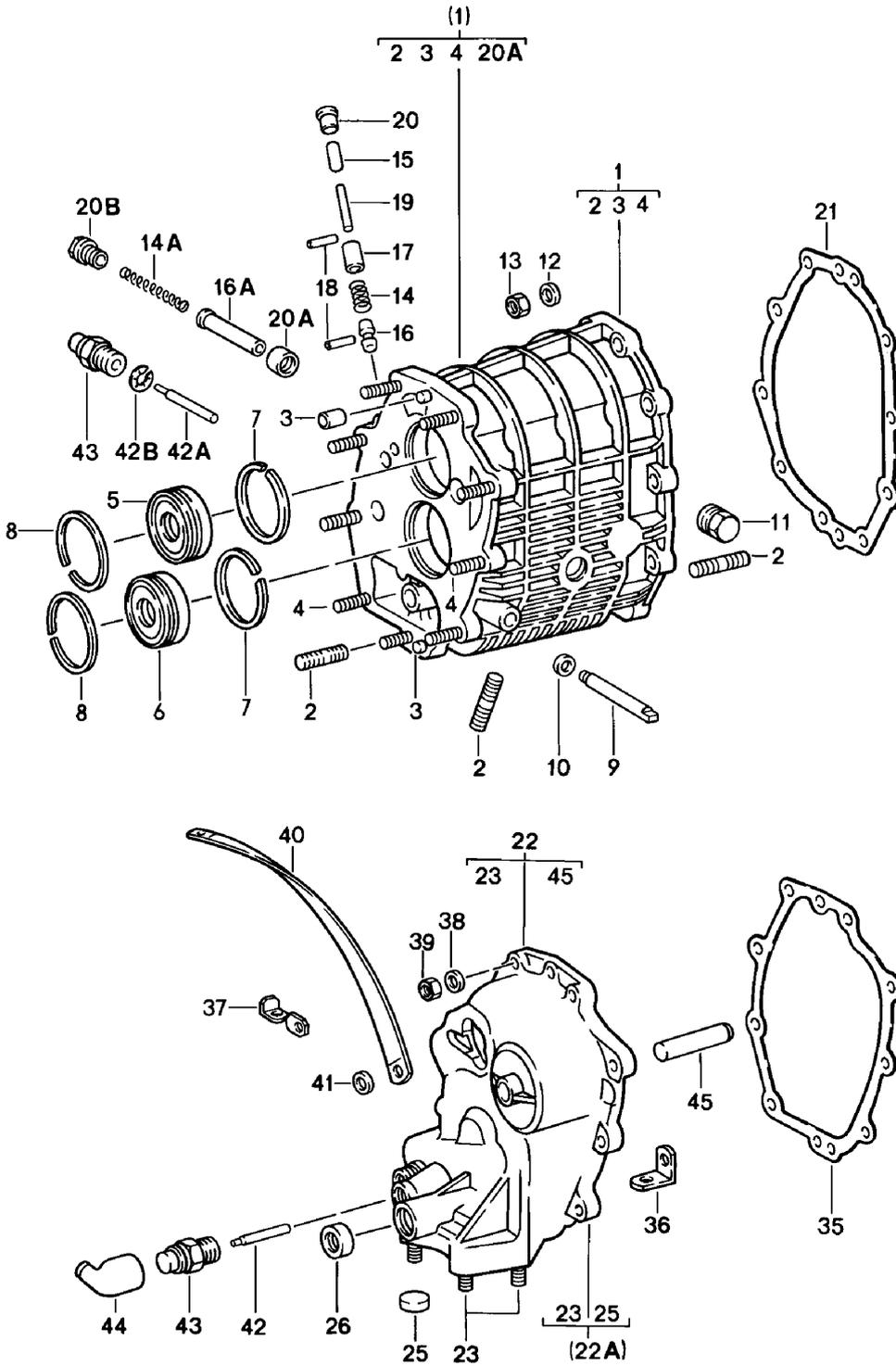

Model: 911 78

Model life 1978>>1983

Pos	Part Number	Description	Remark	Qty	Model
		Gear housing			
		Transmission cover			
1	915 301 902 00	Gear housing		1	SC
(1)	930 301 911 00	Gear housing		1	TURBO
2	999 062 139 02	Stud		13	
2		Stud		13	
		M 8 X 26			
(2)	999 062 007 02	Stud		1	TURBO
(2)	900 060 106 01	Stud		1	TURBO
(2)	999 062 007 02	Stud		1	TURBO
		M 8 X 22			
(2)	900 060 106 01	Stud		1	TURBO
		M 8 X 22			
(2)	999 062 052 02	Stud		1	TURBO
(2)		Stud		1	TURBO
		M 8 X 42			
(2)	999 062 010 02	Stud		3	TURBO
(2)		Stud		3	TURBO
		M 8 X 35			
3	900 012 110 00	Straight pin		2	
		10M 6 X 14			
4	999 062 044 02	Stud		2	SC
4		Stud		2	SC
		M 8 X 30			
(4)	999 062 009 02	Stud		1	TURBO
(4)	900 060 105 01	Stud		1	TURBO
(4)	999 062 009 02	Stud		1	TURBO
		M 8 X 28			
(4)	900 060 105 01	Stud		1	TURBO
		M 8 X 28			
5	999 110 025 00	Cylindrical-roller bearing		1	
6	915 302 399 05	Cylindrical-roller bearing		1	SC
6	915 302 399 06	Cylindrical-roller bearing		1	SC
6	999 110 076 00	Cylindrical-roller bearing		1	TURBO
6	999 110 181 02	Cylindrical-roller bearing		1	TURBO
7	900 111 001 00	Circlip		2	
		SP 62			
8	999 152 031 01	Circlip		2	
		SB 68			
9	914 301 307 00	Bolt		1	
		for			
		Reverse lever			
10	900 025 007 02	Washer		1	
		8,4			
10	900 025 007 03	Washer		1	
		8,4			
11	999 064 019 02	Screw plug		1	SC
		Hexagon socket head bolt			
11	999 064 019 0C	Screw plug		1	SC
11	900 064 009 02	Screw plug		1	TURBO
12	N 012 241 8	Spring washer		10	SC
		B 8			
13	900 076 025 02	Hexagon nut		10	SC
		M 8			
13	900 076 064 02	Hexagon nut		10	SC
		M 8			
14	915 303 232 00	Spring		1	SC
14A	930 303 230 08	Spring		1	TURBO
15	915 303 131 00	Detent		1	SC
16	915 303 130 00	Detent		1	SC
16A	930 303 135 01	Detent		1	TURBO
17	915 303 135 00	Sleeve		1	SC
18	900 308 009 00	Spiral clamping pin		2	SC

Model: 911 78

Model life 1978>>1983

Pos	Part Number	Description	Remark	Qty	Model
		3,5 X 18			
19	915 303 271 00	Pin		1	SC
20	915 301 126 00	Locking bolt		1	SC
20A	999 504 107 00	Threaded insert		1	TURBO
20B	930 303 253 01	Screw plug		1	TURBO
21	915 301 191 00	Gasket		1	SC
21	930 301 191 00	Gasket		1	TURBO
22A	915 301 903 03	Transmission cover		1	SC
22	930 301 903 00	Transmission cover		1	TURBO
23	999 062 005 02	Stud		4	SC
23		Stud		4	SC
		M 8 X 20			
23	999 062 007 02	Stud		4	TURBO
		M 8 X 22			
23	900 060 106 01	Stud		4	TURBO
		M 8 X 22			
25	999 703 385 40	Stopper		1	SC
26	999 113 185 40	Shaft sealing ring		1	
35	915 301 351 00	Gasket		1	SC
35	930 301 351 00	Gasket		1	TURBO
36	901 423 369 00	Retaining bracket	-82	1	
37	915 301 369 00	Clip		1	
38	N 012 241 8	Spring washer		9	
		B 8			
39	900 076 025 02	Hexagon nut		9	
		M 8			
39	900 076 064 02	Hexagon nut		9	
		M 8			
40	999 611 920 20	Ground strap		1	
41	999 151 022 02	Washer		2	
		20 X 8,4 X 2			
42	915 303 145 00	Cam follower		1	SC
42	915 303 145 01	Cam follower		1	SC
42A	930 303 175 01	Pin		1	TURBO
42B	999 041 503 01	Locking ring		1	TURBO
43	914 613 541 02	Back-up light switch		1	
44	914 613 491 00	Protection cap		1	SC
45	930 302 228 00	Bolt		1	TURBO

Model: 911 78

Model life 1978>>1983

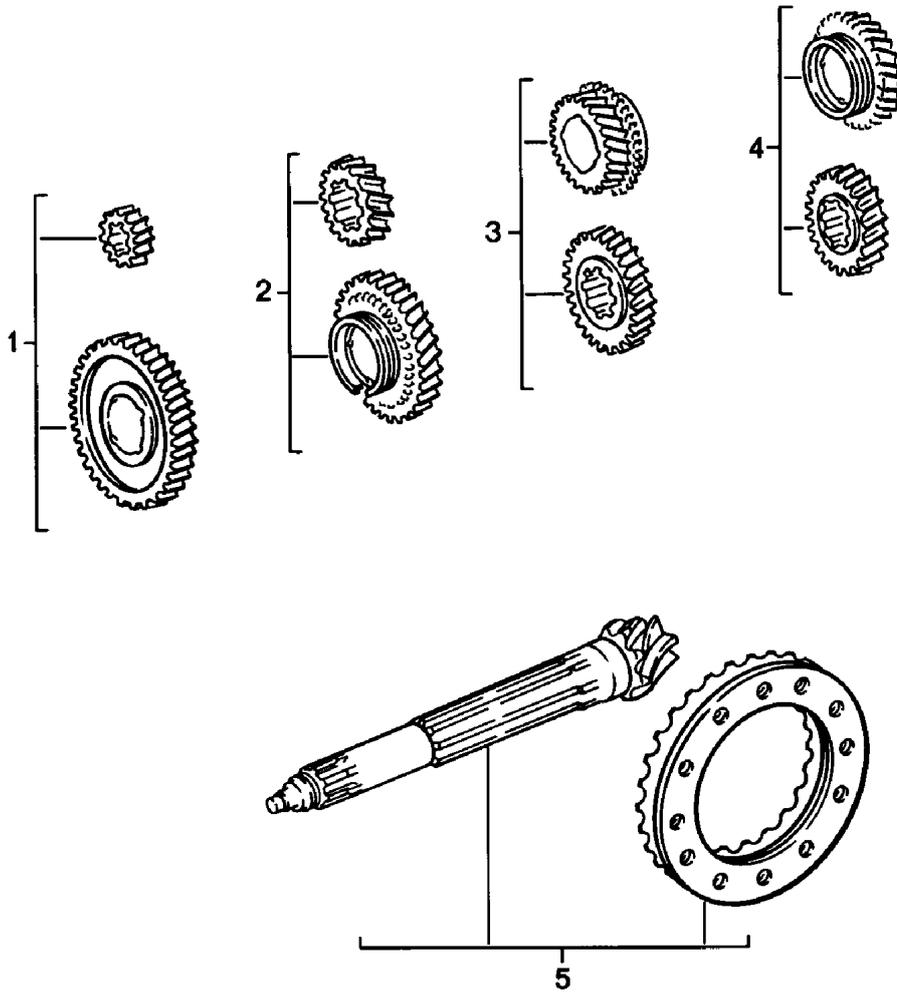

Model: 911 78 Model life 1978>>1983

Pos	Part Number	Description	Remark	Qty	Model
		Gear wheel sets			G 930/34
1	930 302 901 06	4. Speed Transmission Gear set		1	
2	930 302 902 04	1. Speed Z = 16:36 (FA) Gear set		1	
2	930 302 902 06	2. Speed Z = 23:30 (NU) Gear set		1	
2	930 302 902 05	2. Speed Z = 23:30 (NU) Gear wheel pair	(CH) 83-	1	
3	930 302 903 02	3. Speed Z = 24:30 Gear set		1	
3	930 302 903 04	3. Speed Z = 28:25 (SP) Gear set		1	
4	930 302 904 03	4. Speed Z = 28:25 (SP) Gear set		1	
5	930 302 911 01	4. Speed Z = 32:20 (WK) Ring gear and pinion shaft		1	
5	930 302 911 03	9:38 Ring gear and pinion shaft		1	

Model: 911 78

Model life 1978>>1983

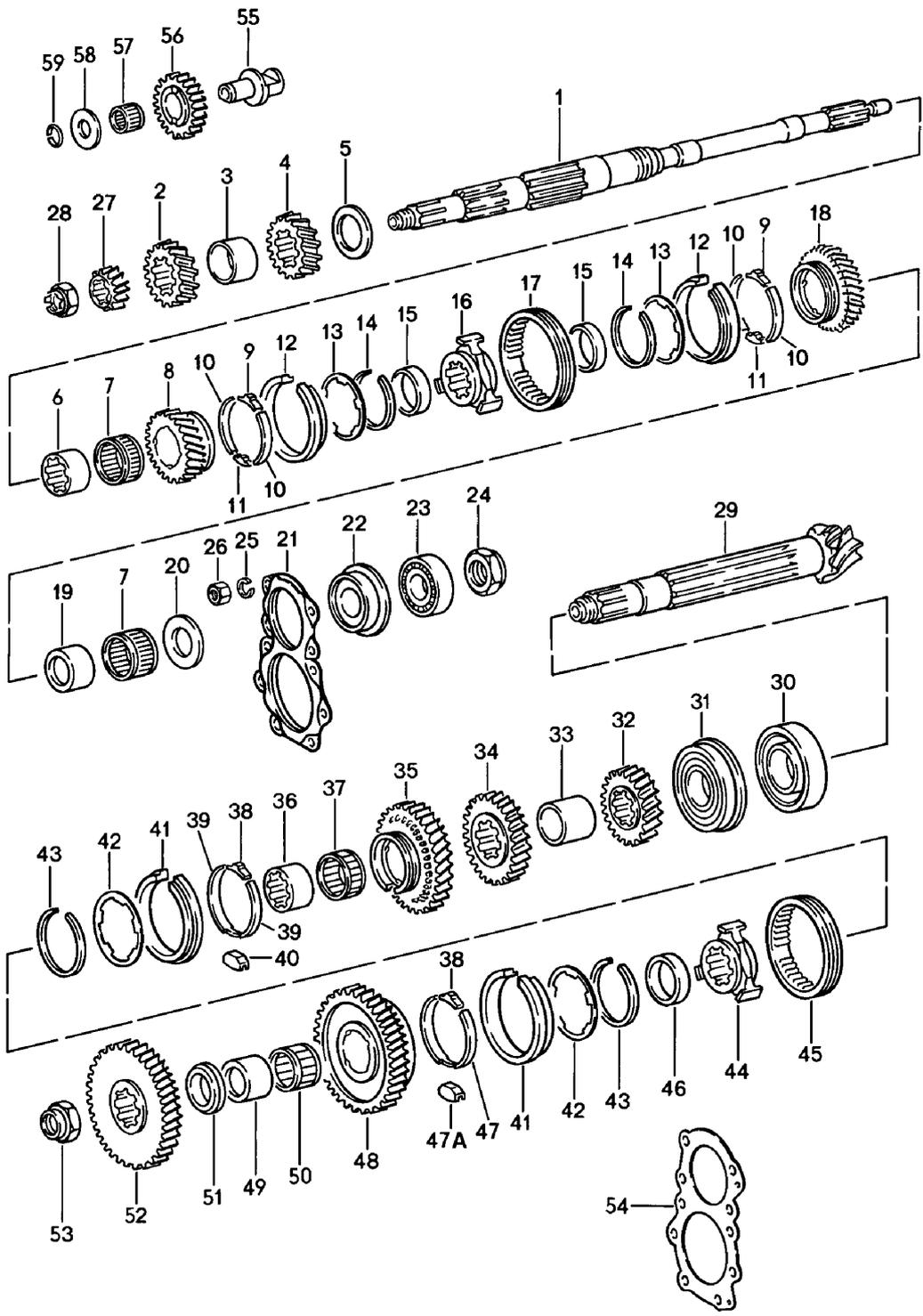

Model: 911 78 Model life 1978>>1983

Pos	Part Number	Description	Remark	Qty	Model
		Gears and shafts			G 930/34
		4.			
		Speed			
		Transmission			
		Gear wheel sets			
		See group			
		3/03/00			
1	930 302 101 01	Drive shaft		1	
2		Fixed gear wheel		1	
		1.			
		Speed			
3	930 302 265 00	Spacer sleeve		1	
4		Fixed gear wheel		1	
		2.			
		Speed			
5	930 302 293 00	Thrust washer		1	
6	930 302 263 00	Bush		1	
		3.			
		Speed			
7	999 201 470 00	Needle cage		2	
8		Loose gear wheel		1	
		3.			
		Speed			
9	930 302 325 00	Stone		2	
		3./4.			
		Speed			
9	930 302 325 11	Stone		2	
		3./4.			
		Speed			
10	911 302 316 00	Spring		4	
10	911 302 316 08	Brake band		4	
		3./4			
		Speed			
11	911 302 317 01	Stop		2	
		3./4			
		Speed			
12	930 302 303 00	Synchroniser ring		2	
		3./4			
		Speed			
13	930 302 311 00	Lock washer		2	
14	930 302 313 01	Circlip		2	
15	930 302 274 00	Spacer ring		2	
16	930 302 402 00	Guide sleeve		1	
16	930 302 402 61	Guide sleeve		1	
17	911 302 411 20	Shift sleeve		1	
17	911 302 411 26	Shift sleeve		1	
17	911 302 411 27	Shift sleeve		1	
18		Loose gear wheel		1	
		4.			
		Speed			
19	930 302 264 00	Bush		1	
		4.			
		Speed			
20	930 302 291 00	Thrust washer		1	
21	930 302 121 00	Tensioning plate		1	
22	999 052 030 00	Four-point bearing		1	
23	930 302 391 00	Cylindrical-roller bearing		1	
23	930 302 391 01	Cylindrical-roller bearing		1	
24	930 302 281 00	Collar nut		1	
25	900 027 015 02	Lock ring		10	
25	900 027 015 03	Lock ring		10	
25	900 027 015 02	Lock ring		10	
25	900 027 015 03	Lock ring		10	

Model: 911 78

Model life 1978>>1983

Pos	Part Number	Description	Remark	Qty	Model
26	900 076 025 02	Hexagon nut M 8		10	
26	900 076 064 02	Hexagon nut M 8		10	
27	930 302 221 00	Reverse gear wheel		1	
27	930 302 221 01	Reverse gear wheel		1	
28	930 302 451 00	Collar nut		1	
29		Pinion shaft		1	
30	999 110 146 00	Cylindrical-roller bearing		1	
30	999 110 146 01	Cylindrical-roller bearing		1	
30	999 110 146 00	Cylindrical-roller bearing		1	
30	999 110 146 01	Cylindrical-roller bearing		1	
31	917 301 391 00	Four-point bearing		1	
32		Fixed gear wheel 4. Speed		1	
33	930 302 266 02	Spacer ring		1	
34		Fixed gear wheel 3. Speed		1	
35		Loose gear wheel 2. Speed		1	
36	930 302 262 00	Bush 2. Speed		1	
37	999 201 047 00	Needle cage		2	
38	930 302 315 00	Stone 2. Speed		1	
38	930 302 316 00	Stone 1. Speed		1	
39	928 302 318 02	Double barricade tape 2. Speed		2	
40	928 302 322 00	Stop 2. Speed		1	
41	930 302 301 00	Synchroniser ring 1st / 2nd gear		2	
42	930 302 331 00	Lock washer		2	
43	930 302 333 01	Circlip		2	
44	930 302 401 00	Guide sleeve		1	
45	930 302 411 01	Shift sleeve		1	
45	930 302 411 02	Shift sleeve		1	
45	930 302 411 03	Shift sleeve		1	
46	930 302 271 00	Spacer ring		1	
47	928 302 319 08	Double barricade tape		1	
47		Double barricade tape 1. Speed		1	
47A	928 302 320 01	Stop 1. Speed		1	
48		Loose gear wheel 1. Speed		1	
49	930 302 261 00	Inner ring		1	
50	999 201 156 00	Needle cage		1	
50		Needle cage		1	
51	930 302 292 00	Thrust washer		1	
52	930 302 223 00	Reverse gear wheel		1	

Model: 911 78

Model life 1978>>1983

Pos	Part Number	Description	Remark	Qty	Model
53	930 302 453 00	Collar nut		1	
54	915 302 268 03	Adjusting shim 0,10 MM		X	
(54)	915 302 268 04	Adjusting shim 0,15 MM		X	
(54)	915 302 268 05	Adjusting shim 0,20 MM		X	
55	930 302 269 01	Sleeve		1	
56	930 302 222 00	Reverse gear wheel		1	
56	930 302 222 02	Reverse idler gear		1	
57	999 201 115 00	Needle cage		1	
58	930 302 229 00	Washer		1	
59	999 152 053 01	Circlip		1	

Model: 911 78

Model life 1978>>1983

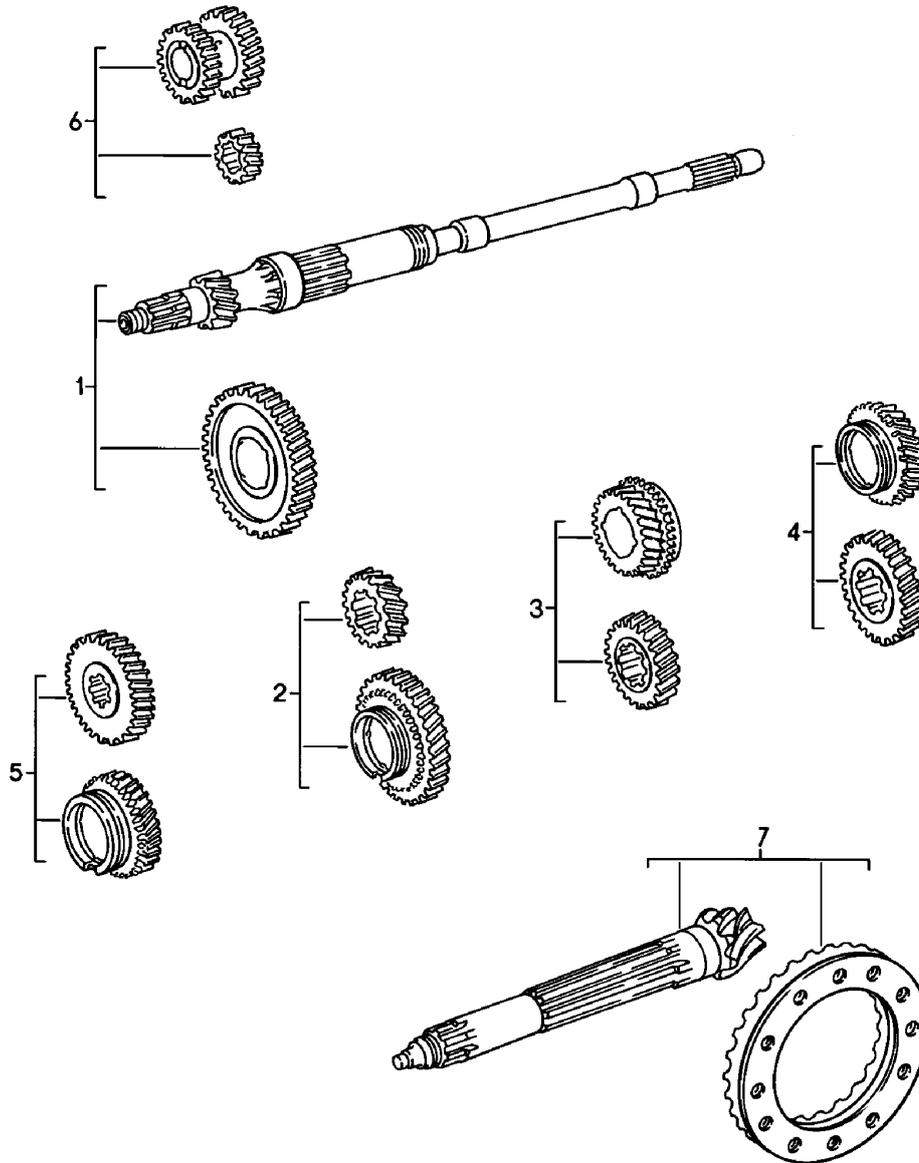

Model: 911 78 Model life 1978>>1983

Pos	Part Number	Description	Remark	Qty	Model
1	915 302 921 14	Gear wheel sets 5. Speed Transmission Transmission G.915.61 Gear set 1. Speed Z = 11:35 (AZ)		1	
1	915 302 921 15	Gear set 1. Speed Z = 11:35 (AZ)		1	
1	915 302 921 16	Gear set 1. Speed Z = 11:35 (AZ)		1	
1	915 302 921 14	Gear set 1. Speed Z = 11:35 (AZ)		1	
1	915 302 921 15	Gear set 1. Speed Z = 11:35 (AZ)		1	
1	915 302 921 16	Gear set 1. Speed Z = 11:35 (AZ)		1	
2	915 302 902 39	Gear wheel pair 2. Speed Z = 18:33 (HX)		1	
3	923 302 903 23	Gear wheel pair 3. Speed Z = 23:29 (NT)		1	
4	923 302 904 28	Gear wheel pair 4. Speed Z = 26:26 (QQ)		1	
5	923 302 905 23	Gear wheel pair 5. Speed Z = 28:23 (SN)		1	
6	915 302 912 04	Gear wheel pair Reverse gear		1	
6	915 302 912 05	Gear wheel pair Reverse gear		1	
7	915 302 911 17	Ring gear and pinion shaft 8:31 Transmission G.915.62		1	
1	915 302 921 14	Gear set 1. Speed Z = 11:35 (AZ)		1	
1	915 302 921 15	Gear set 1. Speed Z = 11:35 (AZ)		1	
1	915 302 921 16	Gear set		1	

Model: 911 78

Model life 1978>>1983

Pos	Part Number	Description	Remark	Qty	Model
1	915 302 921 14	1. Speed Z = 11:35 (AZ) Gear set		1	
1	915 302 921 15	1. Speed Z=11:35 (AZ) Gear set		1	
1	915 302 921 16	1. Speed Z=11:35 (AZ) Gear set		1	
2	915 302 902 39	1. Speed Z=11:35 (AZ) Gear wheel pair		1	
3	923 302 903 23	2. Speed Z = 18:33 (HX) Gear wheel pair		1	
4	923 302 904 28	3. Speed Z = 23:29 (NT) Gear wheel pair		1	
5	923 302 905 28	4. Speed Z = 26:26 (QQ) Gear wheel pair		1	
5	923 302 905 26	5. Speed Z = 28:22 (SN) Gear wheel pair		1	
6	915 302 912 04	5. Speed Z = 28:22 (SN) Gear wheel pair		1	
6	915 302 912 05	Reverse gear Gear wheel pair		1	
7	915 302 911 17	Reverse gear Ring gear and pinion shaft 8:31		1	915.63

Model: 911 78 Model life 1978>>1983

Pos	Part Number	Description	Remark	Qty	Model
		Gears and shafts			G 915
		5.			
		Speed			
		Transmission			
		Gear wheel sets			
		See group			
		3/03/10			
1		Drive shaft		1	
1A	915 302 267 00	Spacer sleeve		1	
2		Fixed gear wheel		1	
		2.			
		Speed			
3	915 302 292 00	Thrust washer		1	
4	915 302 262 00	Bush		2	
5	999 201 470 00	Needle cage		1	
6		Loose gear wheel		1	
		3.			
		Speed			
7	911 302 315 00	Detent		3	
		3./5.			
		Speed			
8	911 302 316 00	Spring		6	
8	911 302 316 08	Brake band		6	
		3./5.			
		Speed			
9	911 302 317 01	Stop		3	
		3./5.			
		Speed			
10	911 302 301 06	Synchroniser ring		3	
		3./5.			
		Speed			
10	911 302 301 13	Synchroniser ring		3	
		3./5.			
		Speed			
11	911 302 311 01	Circlip		3	
12	911 302 402 20	Guide sleeve		1	
13	911 302 411 20	Shift sleeve		1	
13	911 302 411 26	Shift sleeve		1	
13	911 302 411 27	Shift sleeve		1	
14	915 302 261 00	Bush		3	
14	915 302 261 03	Bush		3	
15		Loose gear wheel		1	
		4.			
		Speed			
16	915 302 294 01	Thrust washer		1	
17	915 302 121 03	Tensioning plate		1	
17	915 302 121 04	Tensioning plate		1	
18	999 052 030 00	Four-point bearing		1	
19	999 110 032 00	Cylindrical-roller bearing		1	
20	999 034 033 00	Hexagon nut		1	
21	502 08 310	Hexagon nut		10	
		M 8			
22	900 142 002 01	Lock ring		10	
23		Fixed gear wheel		1	
		5.			
		Speed			
24		Reverse gear wheel		1	
26	900 079 009 00	Castle nut		1	
		M 18 X 1,5			
25	900 309 005 00	Roll pin		1	
		4 X 26			
27		Pinion shaft		1	
28	999 110 146 00	Cylindrical-roller bearing		1	

Model: 911 78

Model life 1978>>1983

Pos	Part Number	Description	Remark	Qty	Model
28	999 110 146 01	Cylindrical-roller bearing		1	
28	999 110 146 00	Cylindrical-roller bearing		1	
28	999 110 146 01	Cylindrical-roller bearing		1	
29	999 052 043 00	Four-point bearing		1	
30	915 302 123 03	Tensioning plate		1	
30	915 302 123 04	Tensioning plate		1	
31		Fixed gear wheel 4. Speed		1	
32	915 302 265 01	Spacer sleeve		1	
33		Fixed gear wheel 3. Speed		1	
34	915 302 293 00	Thrust washer		1	
35		Loose gear wheel 2. Speed		1	
36	915 302 315 01	Stone 2. Speed		1	
37	928 302 318 02	Double barricade tape		1	
37		Double barricade tape 2nd gear		1	
(37)	928 302 319 08	Double barricade tape		1	
(37)		Double barricade tape 1. Speed		1	
38	928 302 322 00	Stop 2. Speed		1	
39	915 302 301 04	Synchroniser ring 2. Speed		1	
(39)	915 302 301 06	Synchroniser ring 1. Speed		1	
40	915 302 311 01	Circlip		2	
41	915 302 401 02	Guide sleeve		1	
42	930 302 411 02	Shift sleeve		1	
42	930 302 411 03	Shift sleeve		1	
43		Loose gear wheel 1. Speed		1	
44	915 302 315 01	Stone 1. Speed		1	
45	928 302 321 00	Stop		1	
46	915 302 291 00	Thrust washer		2	
47	915 302 268 03	Adjusting shim 0,10 MM		1	
47	915 302 268 04	Adjusting shim 0,15 MM		X	
47	915 302 268 05	Adjusting shim 0,20 MM		X	
48		Loose gear wheel 5. Speed		1	
49	915 302 405 01	Guide sleeve		1	
50	915 302 227 09	Shifting gear		1	
51	915 302 282 00	Collar nut		1	
53	915 302 228 03	Bolt		1	
54	999 202 001 00	Needle cage		1	
55	999 201 107 00	Needle cage		2	

Model: 911 78

Model life 1978>>1983

Pos	Part Number	Description	Remark	Qty	Model
56	915 302 231 00	Intermediate ring		1	
57		Reverse idler gear		1	
58	915 302 229 01	Thrust washer		1	
59	999 701 169 40	O-ring		1	
59		O-ring		1	

Model: 911 78

Model life 1978>>1983

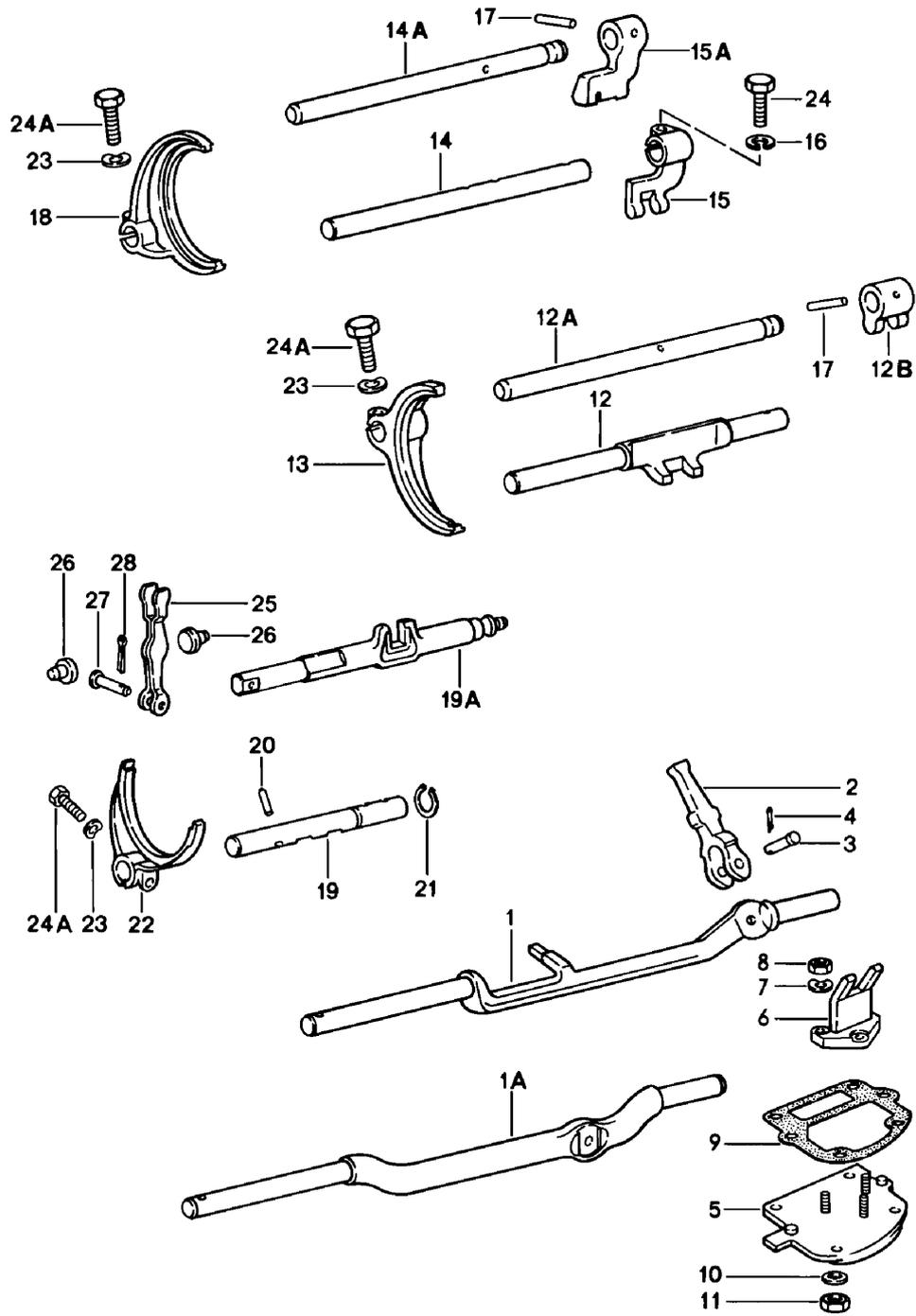

Model: 911 78 Model life 1978>>1983

Pos	Part Number	Description	Remark	Qty	Model
		Shift rods shift forks 5. Speed Transmission			G 915 G 930
1	915 303 132 00	Gear shift rod		1	SC
1A	930 303 132 00	Gear shift rod		1	TURBO
2	915 303 133 00	Shift lever		1	SC
2	930 303 133 00	Shift lever		1	TURBO
3	901 303 171 01	Bolt		1	
4	N 012 512 1	Cotter pin		1	
4		Cotter pin 2 X 12		1	
5	915 303 023 02	Shift cover		1	
6	915 303 129 09	Fork	-81	1	SC
6		Fork		1	SC
(6)	930 303 129 02	Fork		1	TURBO
7	900 027 014 01	Lock ring		3	
7	N 012 006 4	Lock ring B 6		3	
8	900 076 010 02	Nut M 6		3	
8	900 076 010 0B	Nut M 6		3	
9	915 303 225 00	Gasket		1	
10	N 012 241 8	Spring washer		4	
11	900 076 025 02	Hexagon nut M 8		4	
11	900 076 064 02	Hexagon nut M 8		4	
12	915 303 101 00	Gear shift rod 1./2. Speed		1	SC
12A	930 303 101 01	Gear shift rod 1./2. Speed		1	TURBO
12B	930 303 111 03	Shift fork		1	TURBO
13	915 303 111 00	Shift fork 1./2. Speed		1	SC
13	930 303 110 02	Shift fork 1./2. Speed		1	TURBO
14	915 303 103 50	Gear shift rod 3./4. Speed		1	SC
14A	930 303 103 01	Gear shift rod 3./4. Speed		1	TURBO
15	915 303 115 09	Shift fork	-81	1	SC
15	915 303 115 10	Shift fork		1	SC
15	915 303 115 09	Shift fork		1	SC
15	915 303 115 10	Shift fork		1	SC
15A	930 303 115 03	Shift fork		1	TURBO
16	900 027 015 02	Lock ring		1	
16	900 027 015 03	Lock ring		1	
16	900 027 015 02	Lock ring B 8		1	
16	900 027 015 03	Lock ring B 8		1	
17	900 309 003 00	Roll pin 5 X 24		2	TURBO
18	915 303 112 00	Shift fork		1	SC

Model: 911 78

Model life 1978>>1983

Pos	Part Number	Description	Remark	Qty	Model
(18)	930 303 112 02	3./4. Speed Shift fork		1	TURBO
(18)	930 303 112 03	3./4. Speed Shift fork		1	TURBO
19	915 303 105 09	5. Speed Gear shift rod	-81	1	SC
19		5. Speed Reverse gear Gear shift rod		1	SC
19A	930 303 105 03	5. Speed Reverse gear Gear shift rod		1	TURBO
20	900 309 005 00	Reverse gear Roll pin		1	SC
22	915 303 113 01	4 X 26 Shift fork 5th gear		1	SC
23	N 012 241 1	Reverse gear Spring washer		3	
24	900 075 136 02	B 8 X 15 Hexagon-head bolt		1	
24	N 010 233 6	Hexagon-head bolt		1	
24	900 075 136 03	M 8 X 28 Hexagon-head bolt		1	
24A	900 075 099 02	M 8 X 28 Hexagon-head bolt		3	
24A	900 075 099 03	M 8 X 30 Hexagon-head bolt		3	
25	930 303 019 00	M 8 X 30 Reverse lever		1	TURBO
25	930 303 019 01	Reverse lever		1	
26	930 303 121 00	Use also: 930 303 123 01 Spacer bolt		1	
27	930 303 123 00	Bolt		2	TURBO
27	930 303 123 01	Bolt		1	TURBO
28	900 021 002 00	Use also: 930 303 019 01 Cotter pin		1	
28	900 021 002 02	Cotter pin		1	TURBO
		1,5 X 12		1	TURBO

Model: 911 78

Model life 1978>>1983

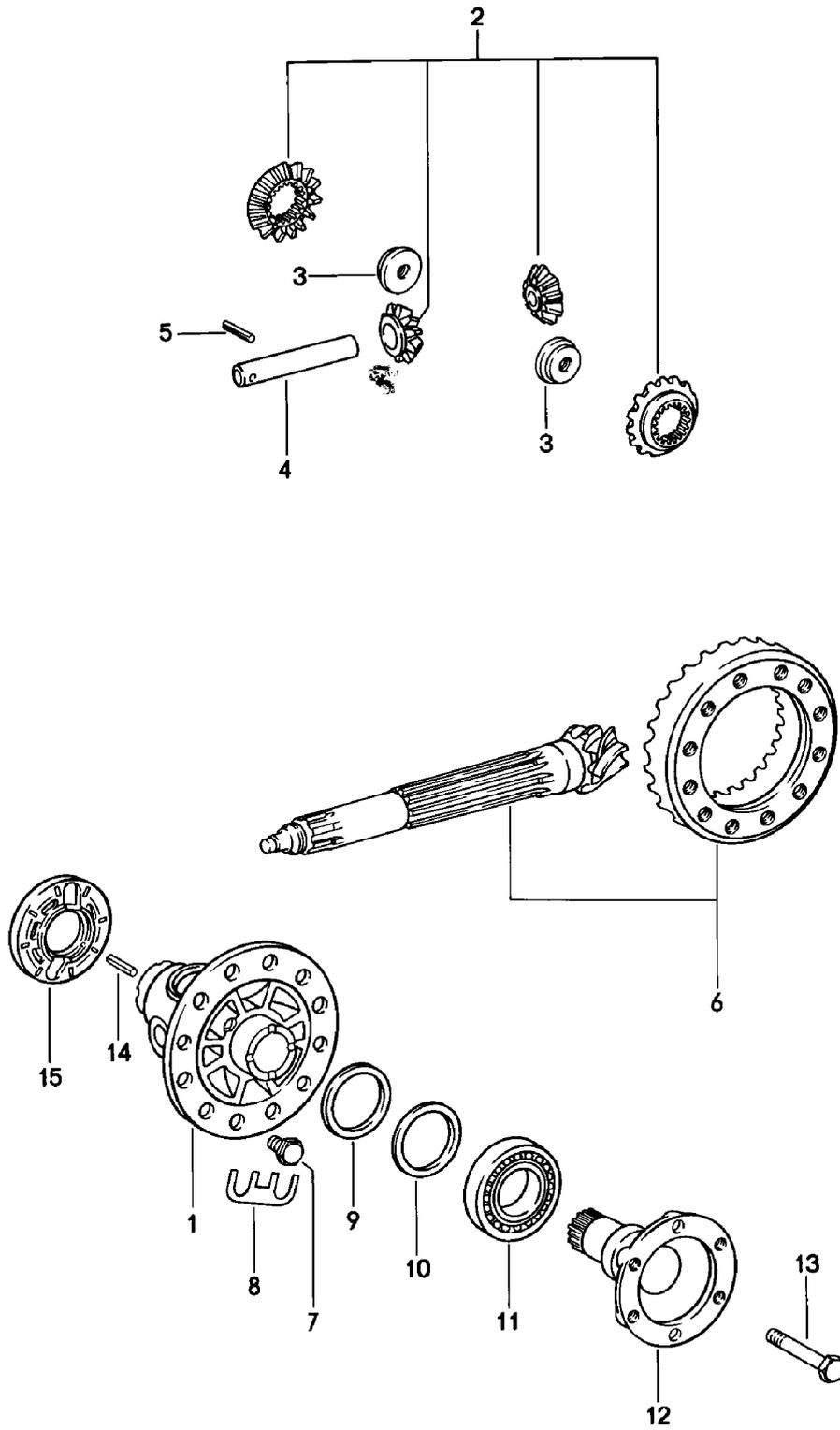

Model: 911 78 Model life 1978>>1983

Pos	Part Number	Description	Remark	Qty	Model
		Differential The following Part number G >> 718 2611 G 718 7923 >> G >> 718 9196 G 719 0011 >> G >> 719 0152 Use			
(1)	925 332 212 01	Housing		1	SC
(2)	911 332 902 00	Differential pinions 1 set		1	SC SC
(3)	911 332 206 01	Nut		2	SC
-	999 152 014 00	Circlip		2	SC
(4)	911 332 207 00	Differential bolt		1	SC
-	911 332 208 00	Armature		1	SC
(5)	900 308 005 00	Roll pin		1	SC
(7)	915 332 276 00	Hexagon-head bolt		12	SC
(12)	923 332 209 02	Joint flange		2	SC
-	901 332 261 11	Washer		2	SC
(13)	901 332 275 12	Elastic bolt		2	SC
1	930 332 212 01	Differential housing F >>91BS1 02621 F >>91BS1 41422 F >>91BS1 21247 F >>91BS1 61178 F >>93BS0 00623 F >>93BS0 50055 F >>91BS1 29622 F >>91BS1 69526		1	
1		Differential housing F 91BS1 02622>> F 91BS1 41423>> F 91BS1 21248>> F 91BS1 61179>> F 93BS0 00624>> F 93BS0 50056>> F 91BS1 29623>> F 91BS1 69527>>		1	
2	928 332 902 00	Housing Differential pinions 1 set F >>91BS1 02621 F >>91BS1 41422 F >>91BS1 21247 F >>91BS1 61178 F >>93BS0 00623 F >>93BS0 50055 F >>91BS1 29622 F >>91BS1 69526		1	
2	928 332 902 01	Differential pinions 1 set F 91BS1 02622>> F 91BS1 41423>> F 91BS1 21248>> F 91BS1 61179>> F 93BS0 00624>> F 93BS0 50056>> F 91BS1 29623>> F 91BS1 69527>>		1	
2	928 332 902 90	Differential pinions 1 set F 91BS1 02622>>		1	

Model: 911 78 Model life 1978>>1983

Pos	Part Number	Description	Remark	Qty	Model
2	950 332 902 90	F 91BS1 41423>> F 91BS1 21248>> F 91BS1 61179>> F 93BS0 00624>> F 93BS0 50056>> F 91BS1 29623>> F 91BS1 69527>> Differential pinions 1 set		1	
3	928 332 279 02	F 91BS1 02622>> F 91BS1 41423>> F 91BS1 21248>> F 91BS1 61179>> F 93BS0 00624>> F 93BS0 50056>> F 91BS1 29623>> F 91BS1 69527>> Nut		2	
3		F >>91BS1 02621 F >>91BS1 41422 F >>91BS1 21247 F >>91BS1 61178 F >>93BS0 00623 F >>93BS0 50055 F >>91BS1 29622 F >>91BS1 69526 Nut		2	
4	005 409 177 00	F 91BS1 02622>> F 91BS1 41423>> F 91BS1 21248>> F 91BS1 61179>> F 93BS0 00624>> F 93BS0 50056>> F 91BS1 29623>> F 91BS1 69527>> Differential bolt		1	
4	928 332 207 05	F >>91BS1 02621 F >>91BS1 41422 F >>91BS1 21247 F >>91BS1 61178 F >>93BS0 00623 F >>93BS0 50055 F >>91BS1 29622 F >>91BS1 69526 Differential bolt		1	
5	900 309 035 00	F 91BS1 02622>> F 91BS1 41423>> F 91BS1 21248>> F 91BS1 61179>> F 93BS0 00624>> F 93BS0 50056>> F 91BS1 29623>> F 91BS1 69527>> Roll pin		1	
6	915 302 911 17	Ring gear and pinion shaft 8 : 31		1	SC
(6)	930 302 911 01	Ring gear and pinion shaft 9 : 38		1	TURBO
(6)	930 302 911 03	Ring gear and pinion shaft 9 : 38		1	TURBO
7	928 332 276 03	Hexagon-head bolt		12	
7		Hexagon-head bolt		12	
8	901 332 285 01	Tab washer		6	

Model: 911 78 Model life 1978>>1983

Pos	Part Number	Description	Remark	Qty	Model
9	915 332 265 00	Adjusting ring 2,4 MM		X	
(9)	915 332 265 01	Adjusting ring 2,5 MM		X	
(9)	915 332 265 02	Adjusting ring 2,6 MM		X	
(9)	915 332 265 03	Adjusting ring 2,7 MM		X	
(9)	915 332 265 04	Adjusting ring 2,8 MM		X	
(9)	915 332 265 05	Adjusting ring 2,9 MM		X	
(9)	915 332 265 06	Adjusting ring 3,0 MM		X	
(9)	915 332 265 07	Adjusting ring 3,1 MM		X	
(9)	915 332 265 08	Adjusting ring 3,2 MM		X	
(9)	915 332 265 09	Adjusting ring 3,3 MM		X	
(9)	915 332 265 10	Adjusting ring 3,4 MM		X	
(9)	915 332 265 11	Adjusting ring 3,5 MM		X	
(9)	915 332 265 12	Adjusting ring 3,6 MM		X	
(9)	915 332 265 13	Adjusting ring 3,7 MM		X	
10	915 332 263 00	Adjusting ring 0,25 MM		X	
11	999 059 027 00	Taper roller bearing		2	
11	999 059 027 02	Taper roller bearing		2	
11	999 059 064 00	Taper roller bearing		2	TURBO
12	930 332 209 03	Joint flange		2	TURBO
12	915 332 209 12	Joint flange		2	SC
13	900 074 291 02	Hexagon-head bolt M 10 X 80		2	
13		Hexagon-head bolt M 10 X 78		2	
14	900 095 078 00	Tensioning sleeve 4 X 14		1	
15	915 318 045 03	Magnet carrier disc		1	

Model: 911 78

Model life 1978>>1983

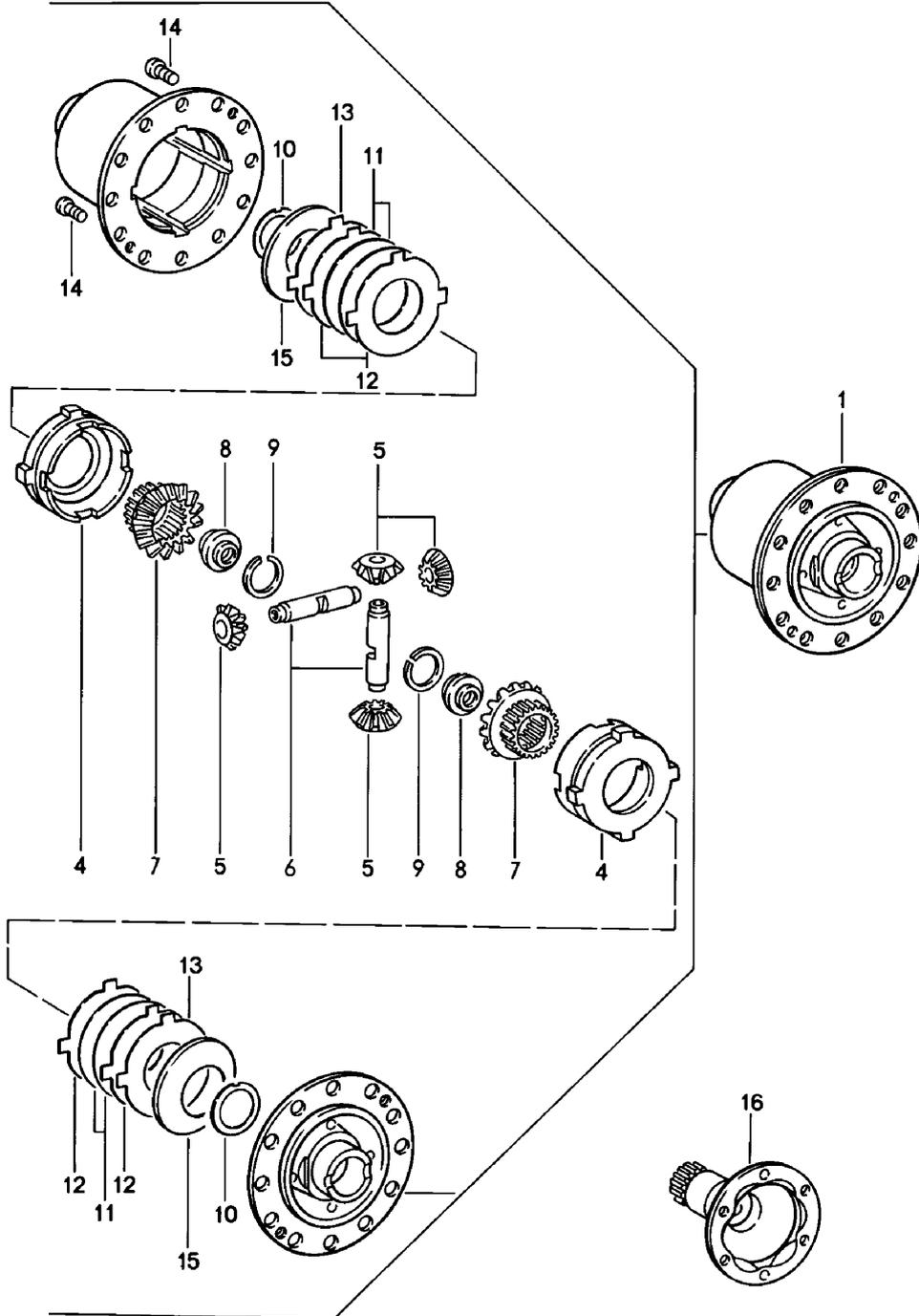

Model: 911 78

Model life 1978>>1983

Pos	Part Number	Description	Remark	Qty	Model
1	915 332 053 12	Limited-slip differential			
		Limited-slip differential	SPM	1	SC
		40 %			
1	930 332 053 03	Limited-slip differential		1	
		40 %			
1		Limited-slip differential		1	
		40 %			
4	901 332 511 11	Thrust ring		2	
5	915 332 531 02	Bevel pinion		4	
5		Bevel pinion		4	
6	915 332 541 02	Differential shaft		2	
6		Differential shaft		2	
7	901 332 535 11	Shaft bevel gear	SPM	2	SC
7	930 332 535 01	Shaft bevel gear		2	
8	901 332 206 12	Threaded piece	SPM	2	SC
8	915 332 206 02	Threaded piece	SPM	2	SC
		Use also:			
-	915 332 541 02	Differential shaft		2	
8	928 332 279 01	Threaded disc		2	
9	999 152 014 00	Circlip	SPM	2	SC
		SW 32			
10	901 332 561 11	Thrust washer		2	
11	928 332 551 00	Inner disc		4	
		2,0 MM			
12	917 332 552 10	Disc with external splines		4	
		1,9 MM			
12	917 332 552 11	Disc with external splines		4	
		2,0 MM			
12	917 332 552 12	Disc with external splines		4	
		2,1 MM			
13	930 332 553 00	Lamina		2	
		1,4 MM			
14	900 119 002 00	Pan-head screw		2	
14	N 014 765 2	Pan-head screw		2	
		M 6 X 10			
-	900 095 078 00	Tensioning sleeve		1	
		4 X 14			
15	928 332 555 00	Cup spring	-81	2	
15		Cup spring		2	
16	915 332 209 12	Joint flange		2	SC
16	925 332 209 05	Joint flange	SPM	2	SC
16	930 332 209 03	Joint flange		2	TURBO

Model: 911 78

Model life 1978>>1983

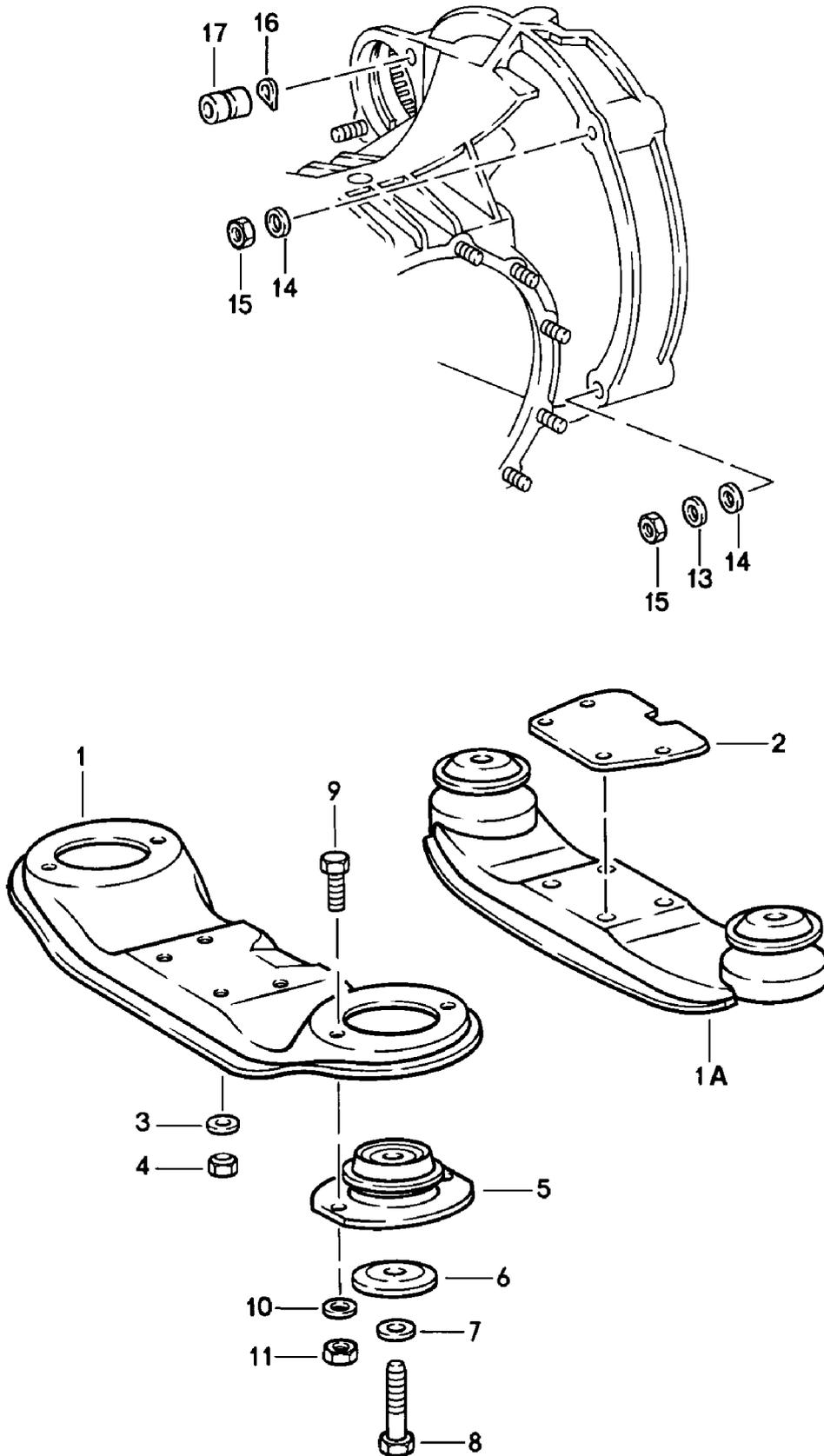

Model: 911 78 Model life 1978>>1983

Pos	Part Number	Description	Remark	Qty	Model
1	911 375 033 01	Transmission suspension		1	SC
1A	930 375 031 00	Transmission carrier		1	TURBO
2	930 375 311 00	Transmission carrier		1	TURBO
2	930 375 311 00	Plate		1	TURBO
3	900 025 007 02	Washer		4	
		8,4			
3	900 025 007 03	Washer		4	
		8,4			
4	900 910 022 02	Lock nut		4	
5	911 375 043 00	Bearing		2	SC
6	901 305 311 00	Seat		4	
7	900 027 017 02	Lock ring		2	
		B 12			
8	901 305 317 00	Hexagon-head bolt		2	SC
(8)	930 375 317 00	Hexagon-head bolt		2	TURBO
(8)	930 375 317 01	Hexagon-head bolt		2	TURBO
9	900 075 087 02	Hexagon-head bolt		4	SC
		M 8 X 16			
9	900 075 087 03	Hexagon-head bolt		4	SC
		M 8 X 16			
10	900 027 015 02	Lock ring		4	SC
		B 8			
10	900 027 015 03	Lock ring		4	SC
		B 8			
11	900 076 025 02	Hexagon nut		4	SC
		M 8			
11	900 076 064 02	Hexagon nut		4	SC
		M 8			
13	999 523 103 01	Schnorr retainng washer		2	SC
		M 10			
14	900 031 005 02	Washer		5	SC
14	900 031 005 03	Washer		5	SC
14	900 031 005 02	Washer		5	SC
		10,5			
14	900 031 005 03	Washer		5	SC
		10,5			
15	900 157 002 02	Hexagon nut		3	
		M 10			
15	900 157 002 03	Hexagon nut		3	
		M 10			
16	N 012 242 3	Spring washer		5	
16		Spring washer		5	
		B 10 X 18			
17	901 104 382 02	Nut		2	
17	901 104 382 03	Nut		2	
17	901 104 382 02	Nut		2	
17	901 104 382 03	Nut		2	

Model: 911 78

Model life 1978>>1983

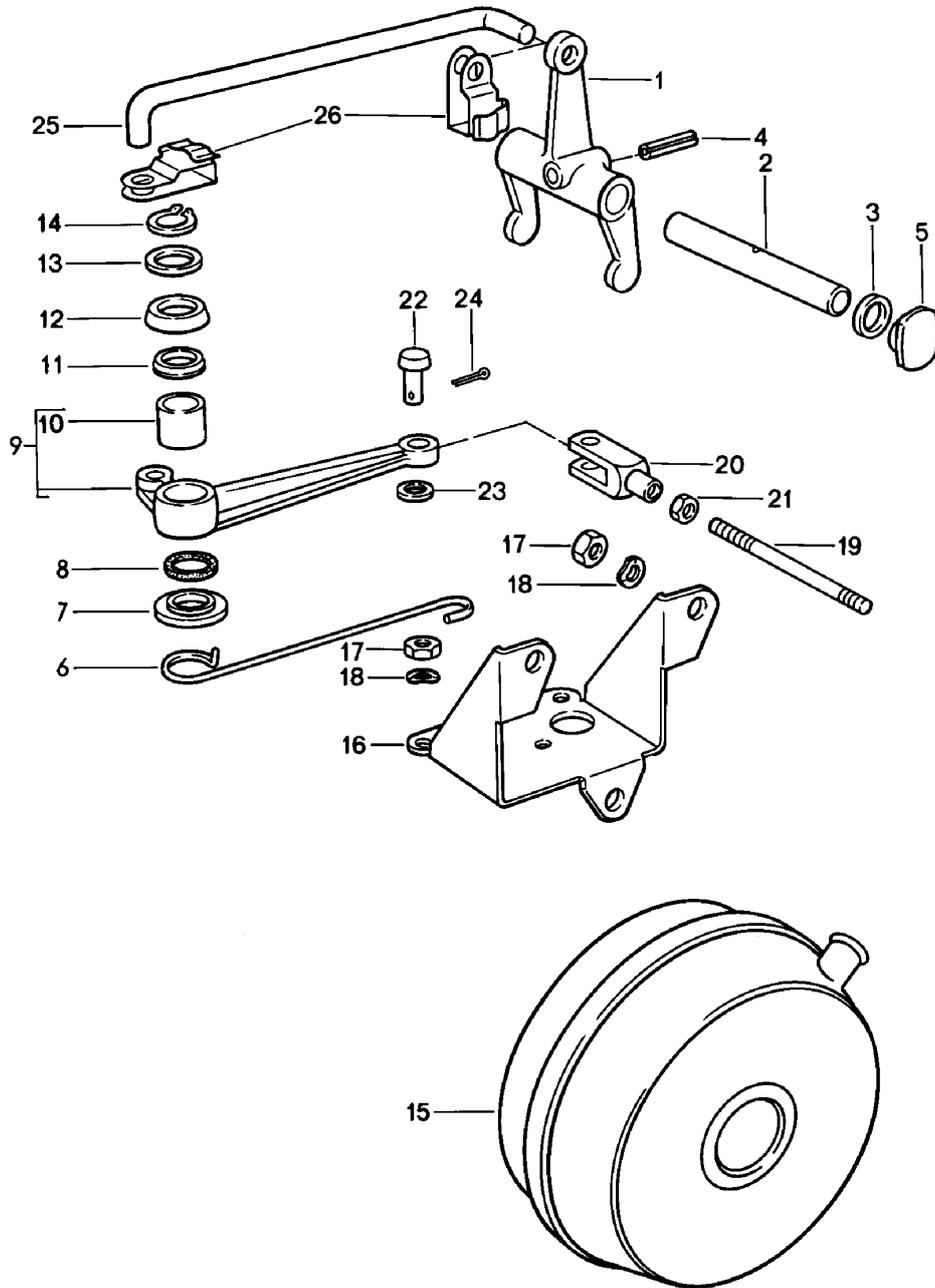

Model: 911 78 Model life 1978>>1983

Pos	Part Number	Description	Remark	Qty	Model
		Clutch release SPM			G 925/16
1	905 116 711 01	Clutch release lever		1	
2	905 116 709 00	Clutch lever shaft		1	
3	905 116 712 00	Spacer ring		2	
4	900 095 013 00	Roll pin		1	
4		Roll pin 4 X 20		1	
5	905 116 713 00	Cap		2	
6	905 116 714 00	Spring		1	
7	905 116 708 00	Washer		1	
8	999 701 169 40	O-ring		1	
8		O-ring		1	
9	914 116 071 15	Intermediate shift lever		1	
10	905 116 701 01	Bush		1	
11	905 116 719 01	Spacer		1	
12	999 704 019 50	Sleeve T 25-1		1	
13	900 234 006 02	Shim 15 X 22 X 1		1	
14	N 012 415 1	Circlip		1	
14		Circlip 15 X 1		1	
15	PCG 116 721 05	Servo-motor 135 X 60		1	
16	925 116 715 00	Servo-motor support		1	
17	900 076 025 02	Hexagon nut M 8		6	
17	900 076 064 02	Hexagon nut M 8		6	
18	900 027 015 02	Lock ring A 8		6	
18	900 027 015 03	Lock ring A 8		6	
19	914 116 716 15	Pull rod		1	
20	900 166 002 02	Clevis G 6 X 24		1	
20	900 166 002 01	Clevis G 6 X 24		1	
21	900 076 010 02	Nut M 6		1	
21	900 076 010 0B	Nut M 6		1	
22	905 116 717 00	Bolt		1	
23	900 089 005 02	Washer 6		1	
24	900 021 002 02	Cotter pin 1,5 X 10		1	
25	925 116 751 06	Push rod		1	
26	925 116 752 00	Clamping spring		2	
-	N 013 295 1	Tensioning sleeve		1	
-		Tensioning sleeve 3 X 12		1	

Model: 911 78

Model life 1978>>1983

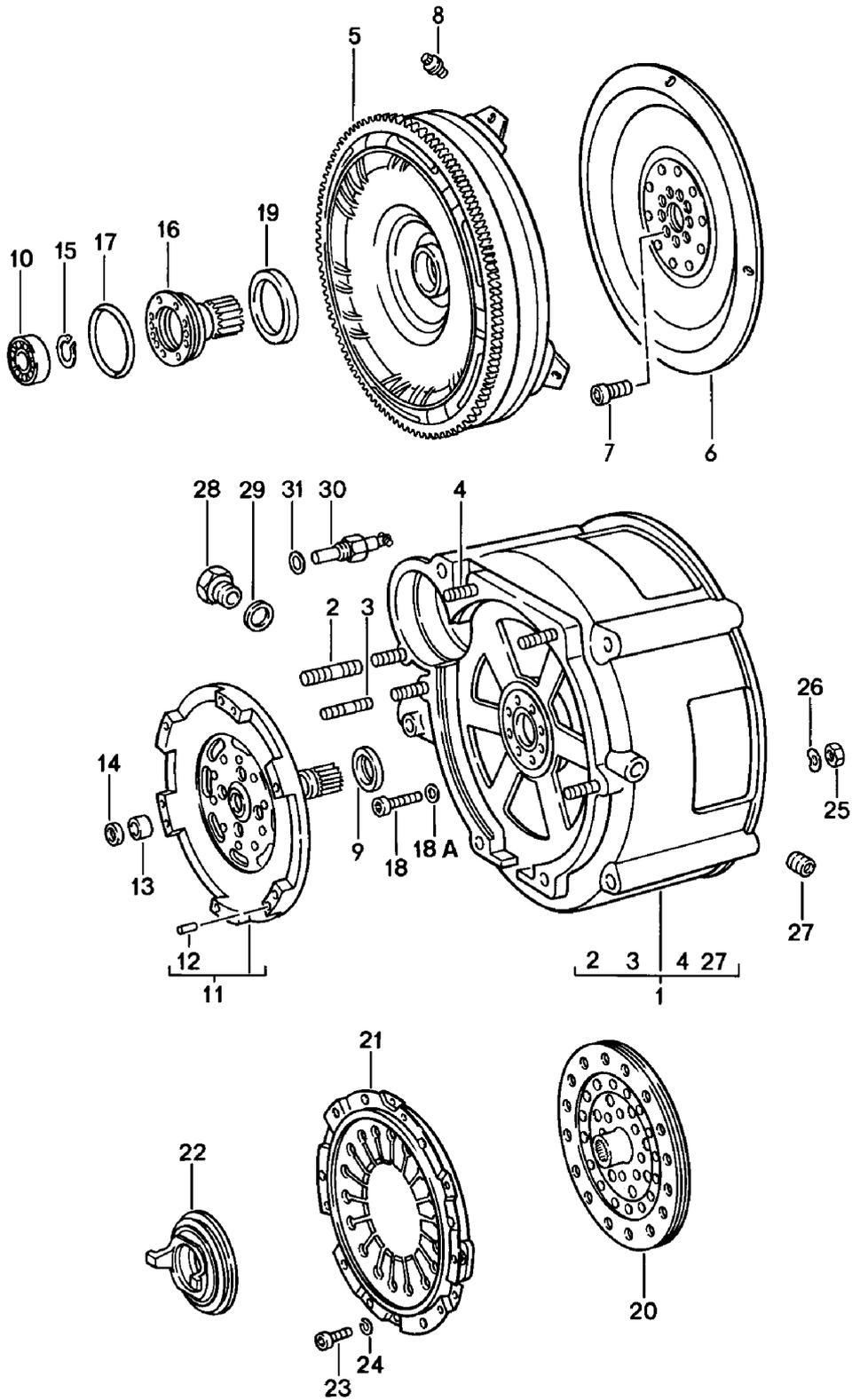

Model: 911 78

Model life 1978>>1983

Pos	Part Number	Description	Remark	Qty	Model
		Converter Converter housing SPM			G 925/16
1	925 301 007 00	Converter housing with studs		1	
2	900 061 014 02	Stud M 10 X 22		1	
3	999 062 008 02	Stud		3	
3		Stud M 8 X 25		3	
4	999 062 009 02	Stud		1	
4	900 060 105 01	Stud		1	
4	999 062 009 02	Stud M 8 X 28		1	
4	900 060 105 01	Stud M 8 X 28		1	
5	925 116 005 10	Converter with Starter ring		1	
6	930 116 131 00	Drive plate		1	
7	930 102 206 00	Pan-head screw		9	
8	905 116 026 00	12 point socket		8	
8	001 301 095 A	Hexagon-head bolt		8	
9	999 113 205 40	Shaft sealing ring 26 X 37 X 7		1	
10	900 052 095 00	Deep-groove ball bearing		1	
10	900 052 095 01	Deep-groove ball bearing		1	
11	925 116 027 00	Turbine shaft		1	
12	999 012 018 00	Straight pin		3	
13	999 201 021 00	Needle sleeve		1	
14	PCG 201 301 00	Shaft sealing ring 12 X 18 X 3		1	
15	N 042 364 1	Circlip		1	
15		Circlip 20 X 1,75		1	
16	925 116 020 01	Free wheel lock		1	
17	999 701 397 40	O-ring OR 72 - 2,5		1	
18	999 186 002 01	Pan-head screw		8	
18A	N 013 804 2	Sealing ring		8	
18A		Sealing ring A 6 X 10		8	
19	999 113 189 40	Radial sealing ring		1	
20	925 116 254 02	Clutch plate		1	
21	925 116 255 05	Clutch pressure plate		1	
22	925 116 081 00	Clutch release bearing		1	
23	999 067 010 01	Pan-head screw		6	
24	N 012 026 3	Lock ring 6		6	
25	N 011 010 6	Hexagon nut M 10		2	
25	N 101 552 10	Hexagon nut M 10		2	
26	N 012 242 3	Spring washer B 10 X 18		2	
27	999 504 090 00	Threaded insert Heli-coil M 12 X 1,5		1	
28	925 301 115 00	Screw socket		1	
29	900 123 060 30	Sealing ring A 24 X 29		1	
30	905 613 102 04	Temperature switch		1	
31	900 123 007 30	Sealing ring		1	

Model: 911 78

Model life 1978>>1983

Pos	Part Number	Description	Remark	Qty	Model
31		Sealing ring A 14 X 18		1	
-	900 124 002 02	Screw plug		1	

Model: 911 78

Model life 1978>>1983

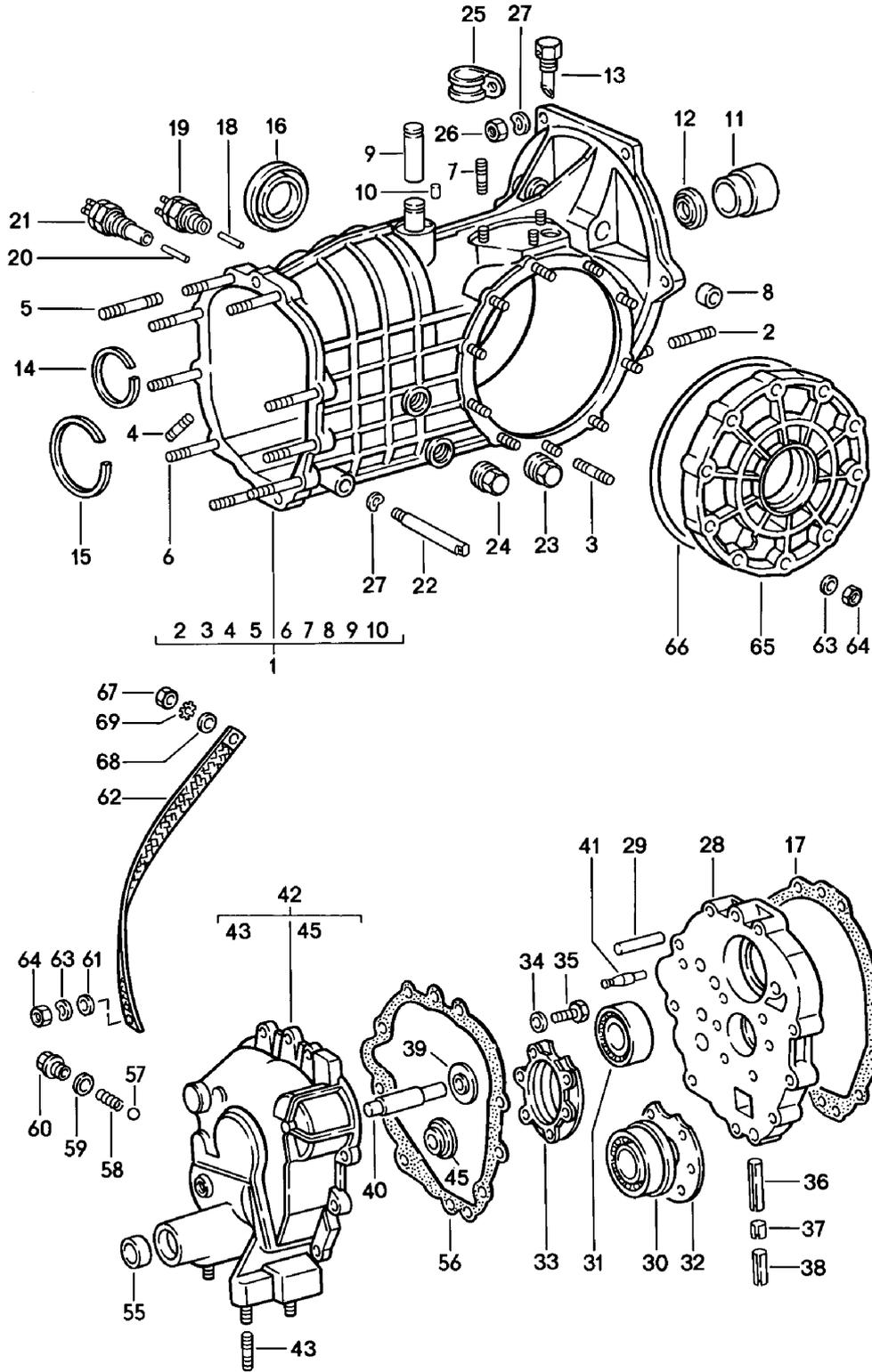

Model: 911 78

Model life 1978>>1983

Pos	Part Number	Description	Remark	Qty	Model
		Replacement transmission Transmission case SPM			G 925/16
-	925 300 010 16	Replacement transmission with converter Ready for installation		1	
1	925 301 010 10	Transmission case		1	
2	900 061 118 02	Stud M 10 X 28		2	
3	999 062 008 02	Stud		10	
3		Stud M 8 X 25		10	
4	900 061 057 02	Stud		2	
4	999 062 073 02	Stud M 8 X 15		2	
5	900 061 070 02	Stud M 8 X 55		8	
6	900 061 050 02	Stud M 8 X 60		1	
7	900 061 004 02	Stud M 8 X 12		3	
8	905 116 727 00	Bush		2	
9	905 116 707 01	Bearing pin		1	
10	900 309 017 00	Roll pin 5 X 12		1	
11	905 116 813 01	Guide tube		1	
12	999 113 286 40	Shaft sealing ring	-79	1	
12		Shaft sealing ring		1	
13	904 301 071 00	Bleeder		1	
14	999 042 301 01	Circlip SB 52		3	
15	999 041 305 01	Circlip SB 79		1	
16	999 113 183 40	Radial shaft seal		2	
16		Radial shaft seal 45 X 68 X 10		2	
17	925 301 191 00	Gasket 0,10 MM		X	
(17)	925 301 191 01	Gasket 0,15 MM		X	
(17)	925 301 191 02	Gasket 0,20 MM		X	
18	905 303 245 02	Cam follower		1	
19	905 613 051 02	Back-up light switch		1	
20	914 303 246 10	Cam follower Bridging switch		1	
21	905 613 101 02	Bridging switch		1	
22	914 301 307 00	Bolt Reverse lever		1	
23	999 064 019 02	Screw plug Hexagon socket head bolt		1	
23	999 064 019 0C	Screw plug		1	
24	999 064 020 02	Screw plug		1	
24		Screw plug with magnet		1	
25	N 020 607 1	Clamp		1	
25		Clamp		1	
26	999 090 101 02	Mid-grip nut		4	
27	900 031 001 02	Washer		5	
27	900 031 105 01	Washer		5	
27	900 025 007 02	Washer 8,4		5	
27	900 025 007 03	Washer		5	

Model: 911 78 Model life 1978>>1983

Pos	Part Number	Description	Remark	Qty	Model
		8,4			
28	925 301 221 00	Intermediate plate		1	
29	900 012 027 00	Straight pin 10 M 6 X 40		2	
30	999 052 016 00	Four-point bearing		1	
30	999 052 016 0A	Four-point bearing		1	
31	900 052 006 00	Deep-groove ball bearing		1	
32	925 301 255 00	Plate		1	
33	925 301 035 00	Tensioning plate		1	
34	900 025 007 02	Washer		6	
34	900 025 007 03	Washer		6	
34	900 025 007 02	Washer		6	
		8,4			
34	900 025 007 03	Washer		6	
		8,4			
35	900 075 083 02	Hexagon-head bolt		6	
35	900 075 029 09	Hexagon-head bolt M 8 X 25		6	
35	900 075 029 03	Hexagon-head bolt M 8 X 25		6	
36	901 303 241 01	Bush		1	
37	905 303 242 00	Bush		1	
38	905 303 243 00	Bush		1	
38		Bush		1	
39	925 302 291 00	Thrust washer		1	
40	925 302 255 00	Bolt		1	
41	925 303 136 00	Bolt		1	
42	925 301 903 00	Transmission cover		1	
43	999 062 006 02	Stud		4	
43		Stud M 8 X 20		4	
45	925 302 292 00	Thrust washer		1	
55	999 113 185 40	Shaft sealing ring 15 X 24 X 7		1	
56	925 301 392 00	Gasket		1	
57	N 025 667 2	Ball		1	
57		Ball 9 MM V		1	
58	905 303 237 00	Spring		1	
59	900 123 007 30	Sealing ring		1	
59		Sealing ring A 14 X 18		1	
60	925 303 238 00	Screw plug		1	
61	999 151 022 02	Washer 20 X 8,4 X 2		2	
62	999 611 918 20	Ground strap		1	
63	N 012 241 8	Spring washer		19	
64	900 076 025 02	Hexagon nut M 8		19	
64	900 076 064 02	Hexagon nut M 8		19	
65	925 301 311 01	Transmission cover		1	
66	999 701 376 40	O-ring 170 X 3,5		1	
67	900 076 030 02	Hexagon nut M 8		1	
68	900 025 007 02	Washer 8,4		1	
68	900 025 007 03	Washer 8,4		1	
69	N 012 132 2	Shake-proof washer		1	
69		Shake-proof washer A 8,4		1	

Model: 911 78

Model life 1978>>1983

Pos	Part Number	Description	Remark	Qty	Model
-	915 301 369 00	Clip		1	

Model: 911 78

Model life 1978>>1983

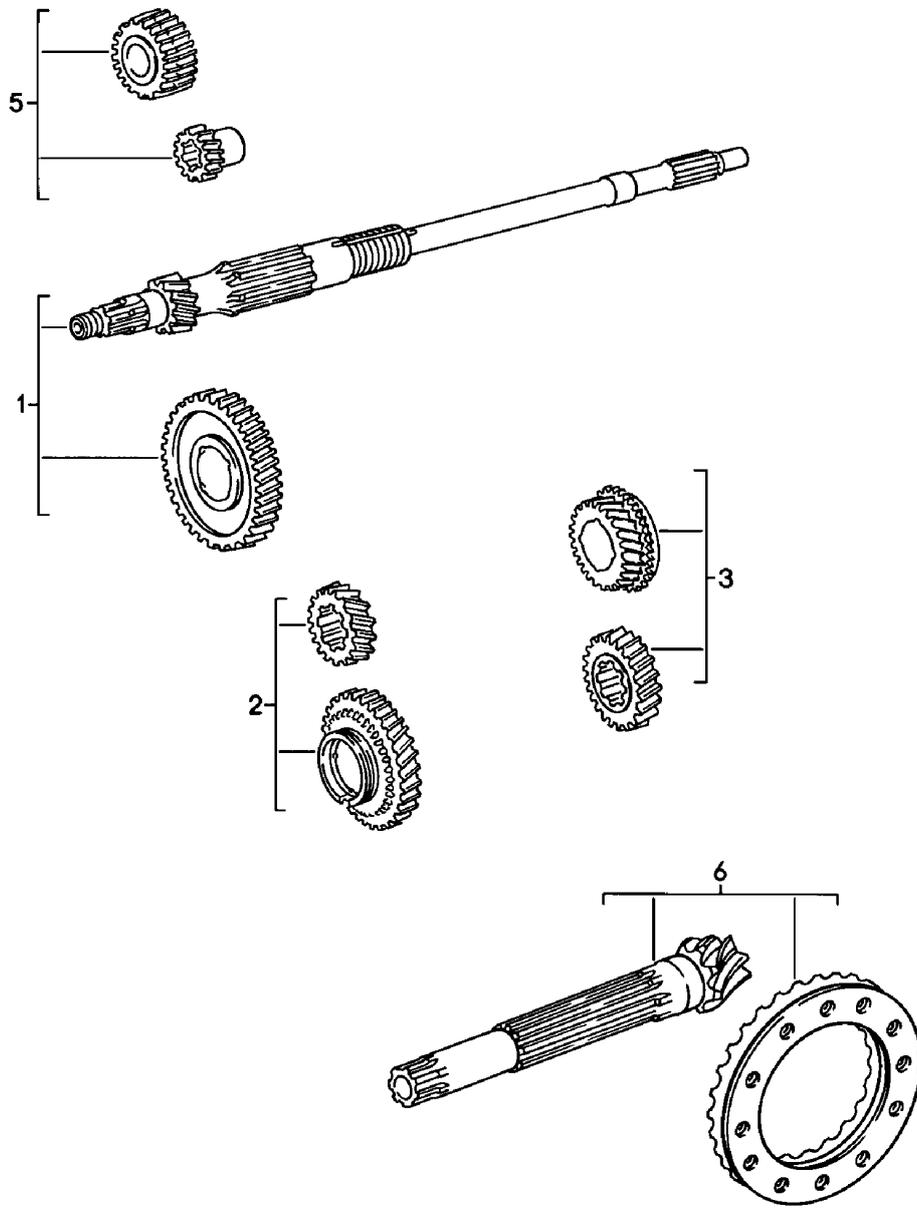

Model: 911 78

Model life 1978>>1983

Pos	Part Number	Description	Remark	Qty	Model
		Gear wheel sets SPM			G 925/16
1	925 302 901 03	Gear set 1. Speed Z = 15:36 (C)		1	
2	925 302 902 15	Gear wheel pair 2. Speed Z = 21:30 (K)		1	
3	925 302 903 50	Gear wheel pair 3. Speed Z = 27:25 (V)		1	
5	925 302 912 00	Gear set Reverse gear		1	
(6)	925 302 911 11	Ring gear and pinion shaft 8:27		1	

Model: 911 78

Model life 1978>>1983

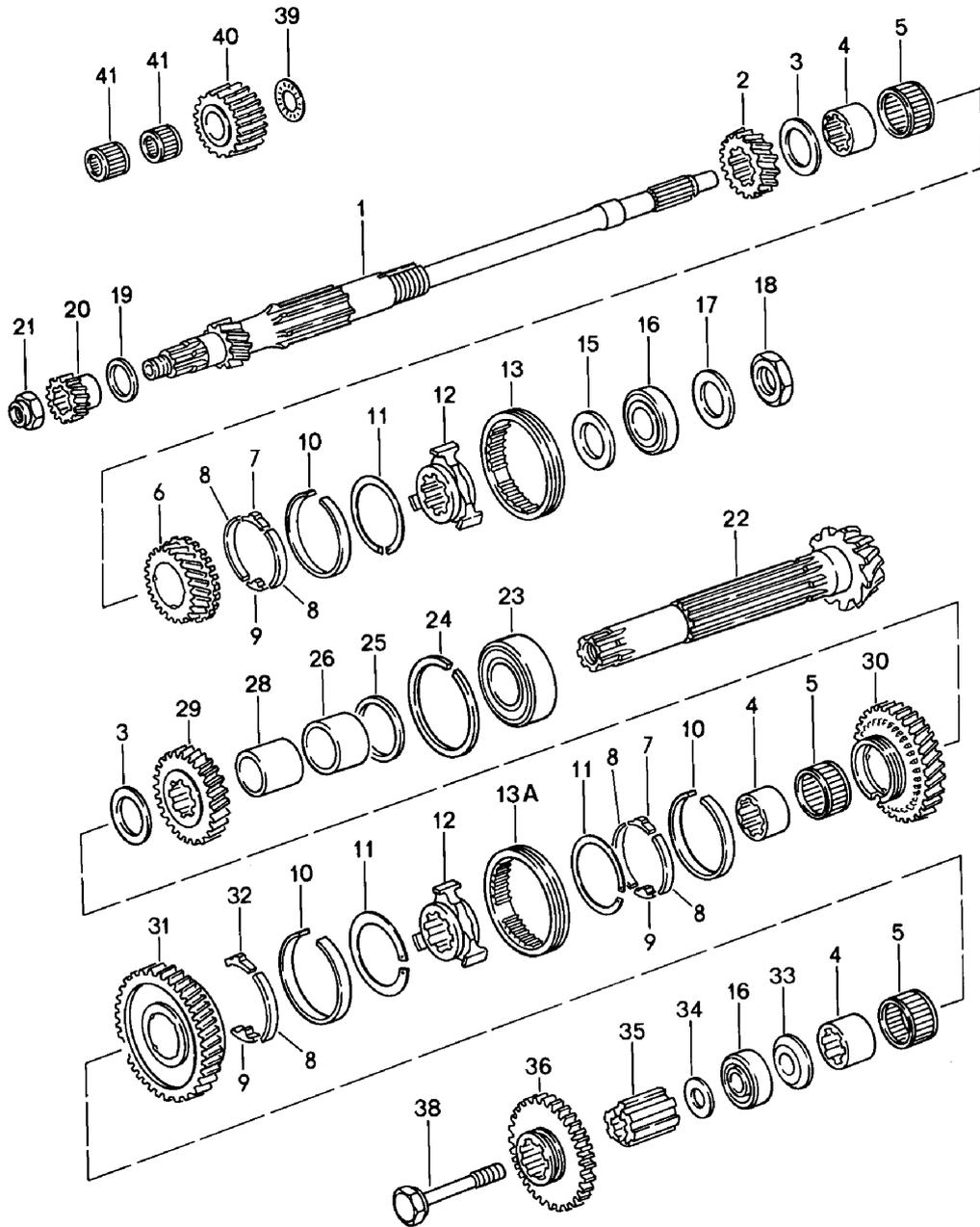

Model: 911 78

Model life 1978>>1983

Pos	Part Number	Description	Remark	Qty	Model
		Gears and shafts SPM Gear wheel sets See group 3/09/00			G 925/16
1		Drive shaft		1	
-	925 302 267 00	Spacer sleeve		1	
2		Fixed gear wheel 2. Speed		1	
3	925 302 294 10	Thrust washer		2	
4	915 302 262 00	Bush		3	
5	999 201 470 00	Needle cage		3	
6		Loose gear wheel 3. Speed		1	
7	911 302 315 00	Detent 2./3. Speed		2	
8	911 302 316 00	Spring		5	
8	911 302 316 08	Brake band		5	
9	911 302 317 01	Stop		3	
9		Stop		3	
10	925 302 301 02	Synchroniser ring		3	
11	911 302 311 01	Circlip		3	
12	911 302 402 20	Guide sleeve		2	
13	911 302 411 20	Shift sleeve 3. Speed		1	
13	911 302 411 26	Shift sleeve 3.		1	
13	911 302 411 27	Shift sleeve 3. Speed		1	
13A	911 302 411 24	Shift sleeve 1./2. Speed		1	
-	925 302 263 10	Spacer sleeve		1	
15	925 302 264 10	Washer		1	
16	999 110 008 00	Cylindrical-roller bearing		2	
16		Cylindrical-roller bearing		2	
17	999 038 001 00	Tab washer		1	
18	999 183 001 00	Hexagon nut		1	
19	925 302 259 10	Spacer ring		1	
20		Reverse gear wheel		1	
21	925 302 283 00	Collar nut		1	
22		Pinion shaft		1	
23	999 110 007 00	Cylindrical-roller bearing		1	
23	999 110 012 00	Cylindrical-roller bearing		1	
23	999 110 012 01	Cylindrical-roller bearing		1	
24	900 111 002 00	Circlip SP 72		1	
25	901 302 297 01	Adjusting shim 0,25 MM		X	
(25)	901 302 297 11	Adjusting shim 0,30 MM		X	
(25)	901 302 297 21	Adjusting shim 0,40 MM		X	
26	925 302 266 10	Spacer sleeve		1	
28	901 302 265 01	Spacer sleeve		1	
29		Fixed gear wheel 3.		1	

Model: 911 78

Model life 1978>>1983

Pos	Part Number	Description	Remark	Qty	Model
30		Speed Loose gear wheel 2.		1	
31		Speed Loose gear wheel 1.		1	
32	901 302 318 02	Speed Detent 1.		1	
33	901 302 268 01	Speed Spacer 5,8 mm		1	
34	925 302 281 00	Spacer		1	
35	925 302 257 00	Spline shaft sleeve		1	
36	925 302 224 00	Sliding gear Reverse gear		1	
38	925 302 271 00	Elastic bolt		1	
39	999 202 001 00	Needle cage		1	
40		Reverse idler gear		1	
41	999 201 106 00	Needle cage		2	

Model: 911 78

Model life 1978>>1983

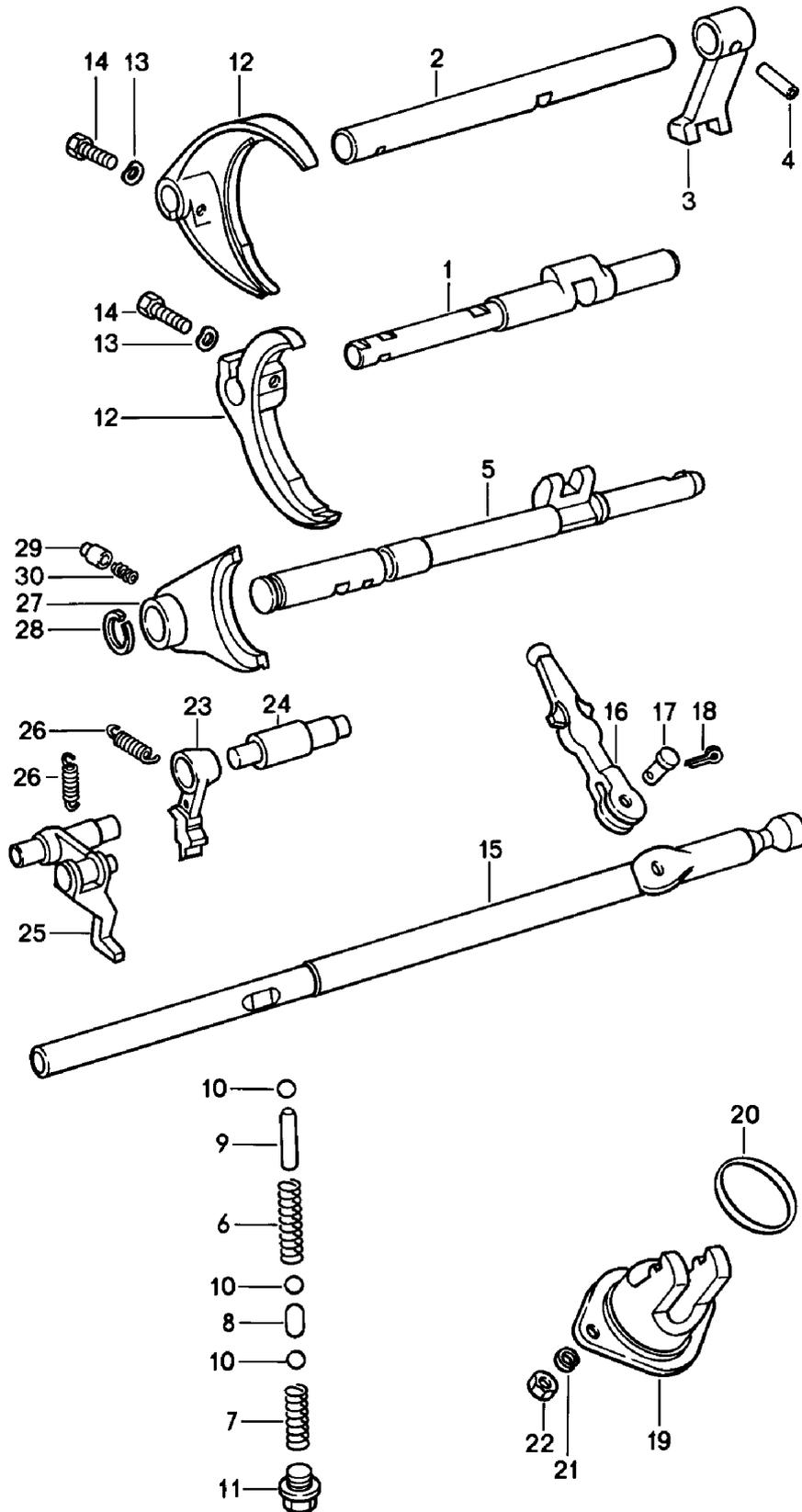

Model: 911 78

Model life 1978>>1983

Pos	Part Number	Description	Remark	Qty	Model
		Shift rods shift forks SPM			G 925/16
1	901 303 101 01	Gear shift rod 1./2. Speed		1	
2	925 303 103 00	Gear shift rod 3. Speed		1	
-	900 041 023 01	Circlip		1	
-		Circlip 14 X 1		1	
3	925 303 161 00	Contact		1	
4	900 309 003 00	Roll pin 5 X 24		1	
5	925 303 141 01	Gear shift rod Reverse gear		1	
6	901 303 232 01	Compression spring		1	
7	905 303 232 01	Compression spring		1	
8	905 303 211 00	Detent		1	
9	901 303 271 01	Pin		1	
10	N 025 667 2	Ball		3	
10		Ball 9 MM V		3	
11	999 065 004 02	Screw plug		1	
12	901 303 111 01	Shift fork		2	
13	N 012 241 1	Spring washer B 8 X 15		2	
14	900 075 083 02	Hexagon-head bolt		2	
14	900 075 029 09	Hexagon-head bolt M 8 X 25		2	
14	900 075 029 03	Hexagon-head bolt M 8 X 25		2	
15	905 303 132 20	Gear shift rod		1	
16	901 303 133 01	Gearshift lever		1	
17	901 303 171 01	Bolt		1	
18	N 012 512 1	Cotter pin		1	
18		Cotter pin 2 X 12		1	
19	925 303 129 11	Fork		1	
20	999 701 359 40	O-ring OR 40 X 1,5		1	
21	900 027 015 02	Lock ring		2	
21	900 027 015 03	Lock ring		2	
21	900 027 015 02	Lock ring B 8		2	
21	900 027 015 03	Lock ring B 8		2	
22	900 076 025 02	Hexagon nut M 8		2	
22	900 076 064 02	Hexagon nut M 8		2	
23	925 303 137 01	Stop		1	
24	925 303 138 00	Shaft		1	
25	925 303 015 02	Lever		1	
26	905 303 235 00	Tension spring		2	
27	925 303 151 00	Shift fork		1	
-	999 152 023 01	Circlip SB 22		1	
28	999 041 301 01	Circlip SW 18		1	
29	925 303 149 01	Locking bolt		1	
30	925 303 148 01	Spring		1	

Model: 911 78

Model life 1978>>1983

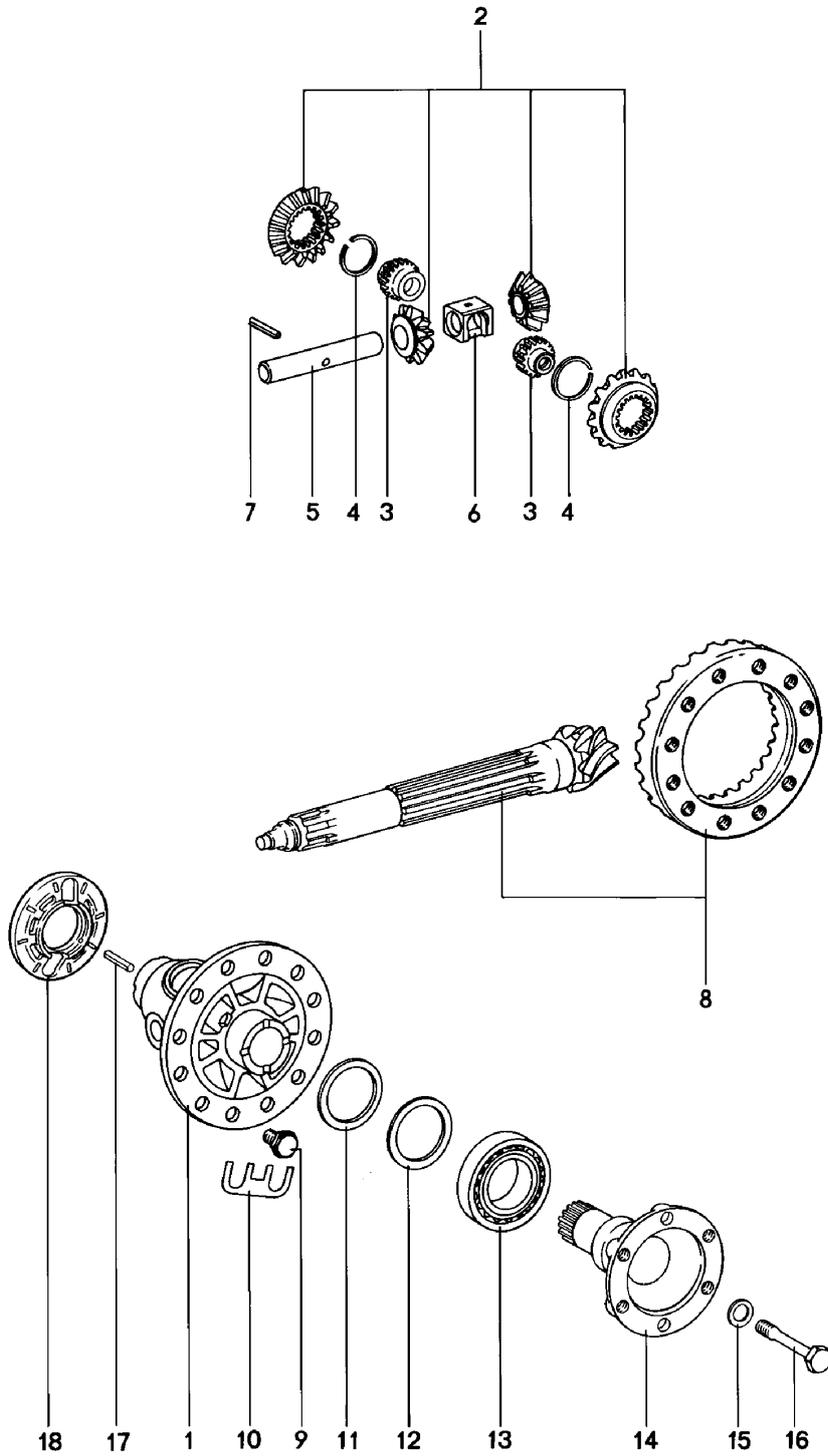

Model: 911 78 Model life 1978>>1983

Pos	Part Number	Description	Remark	Qty	Model
		Differential SPM			G 925/16
1	925 332 212 01	Housing		1	
2	911 332 902 00	Differential pinions 1 set		1	
3	911 332 206 01	Nut		2	
4	999 152 014 00	Circlip		2	
5	911 332 207 00	Differential bolt		1	
6	911 332 208 00	Armature		1	
7	900 308 005 00	Roll pin		1	
8	925 302 911 11	Ring gear and pinion shaft 8 : 27		1	
9	915 332 276 00	Hexagon-head bolt		12	
10	901 332 285 01	Tab washer		6	
11	915 332 265 00	Adjusting ring 2,4 MM		X	
(11)	915 332 265 01	Adjusting ring 2,5 MM		X	
(11)	915 332 265 02	Adjusting ring 2,6 MM		X	
(11)	915 332 265 03	Adjusting ring 2,7 MM		X	
(11)	915 332 265 04	Adjusting ring 2,8 MM		X	
(11)	915 332 265 05	Adjusting ring 2,9 MM		X	
(11)	915 332 265 06	Adjusting ring 3,0 MM		X	
(11)	915 332 265 07	Adjusting ring 3,1 MM		X	
(11)	915 332 265 08	Adjusting ring 3,2 MM		X	
(11)	915 332 265 09	Adjusting ring 3,3 MM		X	
(11)	915 332 265 10	Adjusting ring 3,4 MM		X	
(11)	915 332 265 11	Adjusting ring 3,5 MM		X	
(11)	915 332 265 12	Adjusting ring 3,6 MM		X	
(11)	915 332 265 13	Adjusting ring 3,7 MM		X	
12	915 332 263 00	Adjusting ring		2	
13	999 059 027 00	Taper roller bearing		2	
13	999 059 027 02	Taper roller bearing		2	
14	925 332 209 04	Joint flange		2	
15	901 332 261 11	Washer		2	
16	901 332 275 12	Elastic bolt		2	
17	900 095 078 00	Tensioning sleeve		1	
18	915 318 045 03	Magnet carrier disc		1	

Model: 911 78

Model life 1978>>1983

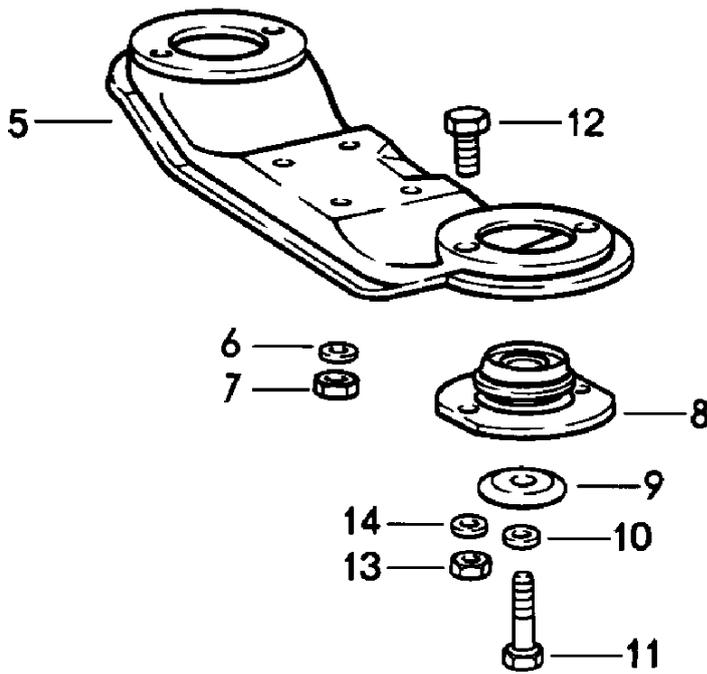
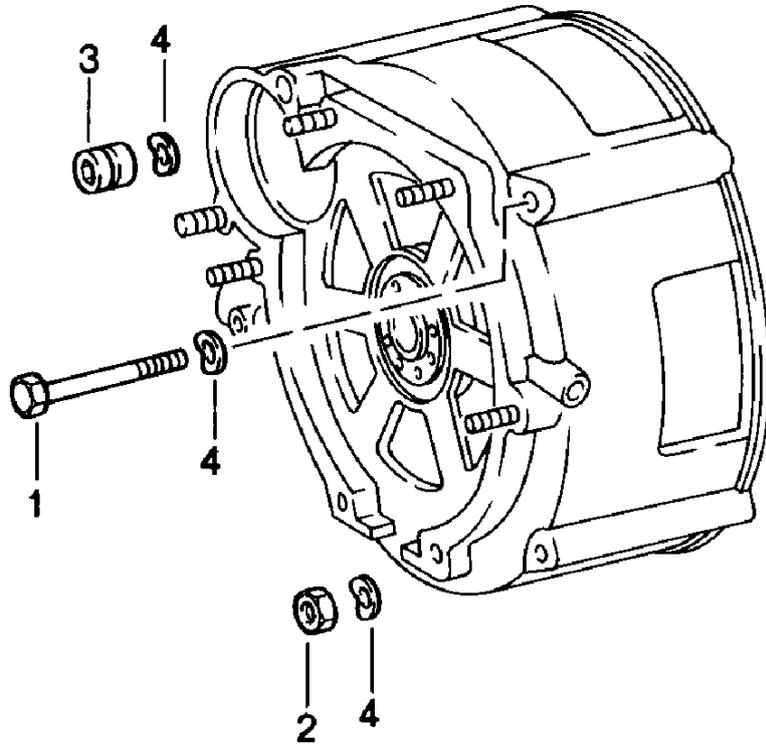

Model: 911 78 Model life 1978>>1983

Pos	Part Number	Description	Remark	Qty	Model
		Transmission suspension SPM			G 925/16
1	900 155 018 02	Hexagon-head bolt M 10 X 110		1	
2	900 157 002 02	Hexagon nut M 10		2	
2	900 157 002 03	Hexagon nut M 10		2	
3	901 104 382 02	Nut		2	
3	901 104 382 03	Nut		2	
3	901 104 382 02	Nut		2	
3	901 104 382 03	Nut		2	
4	N 012 242 3	Spring washer B 10 X 18		5	
5	911 375 033 01	Transmission carrier		1	
6	900 031 001 02	Washer		4	
6	900 031 105 01	Washer		4	
6	900 025 007 02	Washer 8,4		4	
6	900 025 007 03	Washer 8,4		4	
7	999 090 101 02	Mid-grip nut		4	
8	911 375 043 00	Bearing		2	
9	901 305 311 00	Seat		2	
10	900 027 017 02	Lock ring B 12		2	
11	901 305 317 00	Hexagon-head bolt		2	
11	930 375 317 00	Hexagon-head bolt Use also:		2	
11	930 375 317 01	Hexagon-head bolt Use also:		2	
-	999 025 074 02	Washer		2	
-	999 025 074 01	Washer		2	
12	900 075 087 02	Hexagon-head bolt		4	
12	900 075 087 03	Hexagon-head bolt		4	
12	900 075 087 02	Hexagon-head bolt M 8 X 16		4	
12	900 075 087 03	Hexagon-head bolt M 8 X 16		4	
13	900 076 025 02	Hexagon nut M 8		4	
13	900 076 064 02	Hexagon nut M 8		4	
14	900 027 015 02	Lock ring		4	
14	900 027 015 03	Lock ring		4	
14	900 027 015 02	Lock ring B 8		4	
14	900 027 015 03	Lock ring B 8		4	

Model: 911 78

Model life 1978>>1983

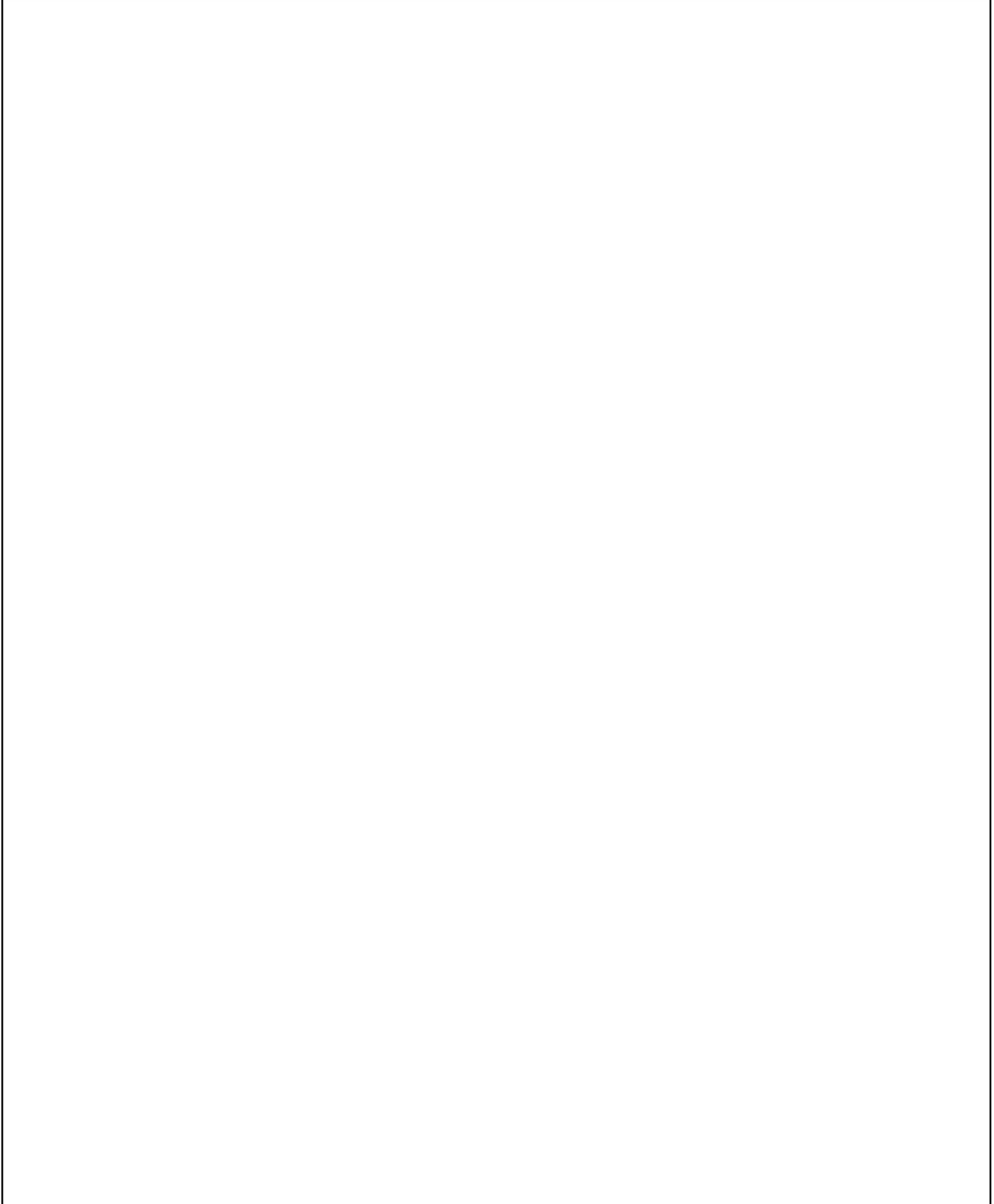

Model: 911 78

Model life 1978>>1983

Pos	Part Number	Description	Remark	Qty	Model
>>	915 300 911 00	Gasket set Gasket set for Transmission Comprising:		1	G 915
-	915 301 139 00	Sealing ring		1	
-	999 113 183 40	Radial shaft seal 45 X 68 X 10		2	
-	999 113 182 40	Shaft sealing ring 23 X 40 X 10		1	
-	999 113 327 40	Shaft sealing ring 23 X 35 X 8/11		1	
-	999 701 392 40	O-ring OR 195 X 3,5		1	
-	915 301 191 00	Gasket		1	
-	900 123 066 30	Sealing ring A 10 X 16		2	
-	999 113 185 40	Shaft sealing ring 15 X 24 X 7		1	
-	999 701 349 40	O-ring 17,5 X 2,4		1	
-	999 113 175 40	Shaft sealing ring 6 X 15 X 6		1	
-	915 301 351 00	Gasket		1	
-	999 701 169 40	O-ring 14,3 X 2,4		1	
-	915 303 225 00	Gasket		1	
>>	930 300 911 00	Gasket set for Transmission Comprising:		1	G 930/34
-	915 301 139 00	Sealing ring		1	
-	999 113 183 40	Radial shaft seal		2	
-	999 701 437 40	O-ring		1	
-	930 302 332 00	Shaft sealing ring		1	
-	999 701 440 40	O-ring		1	
-	930 301 191 00	Gasket		1	
-	999 113 185 40	Shaft sealing ring		1	
-	930 301 351 00	Gasket		1	
-	915 303 225 00	Gasket		1	
>>	925 300 911 00	Gasket set for Transmission Comprising:		1	G 925/16
-	999 113 205 40	Shaft sealing ring 26 X 37 X 7		1	
-	PCG 201 301 00	Shaft sealing ring 12 X 18 X 3		1	
-	999 701 397 40	O-ring 72 X 2,5		1	
-	N 013 804 2	Sealing ring A 6 X 10		8	
-	999 113 189 40	Radial sealing ring		1	
-	900 123 060 30	Sealing ring A 24 X 29		1	
-	900 123 007 30	Sealing ring A 14 X 18		2	
-	999 113 286 40	Shaft sealing ring		1	
-	999 113 183 40	Radial shaft seal 45 X 68 X 10		2	
-	925 301 191 00	Gasket 0,10 MM		1	
-	925 301 191 01	Gasket		1	

Model: 911 78 Model life 1978>>1983

Pos	Part Number	Description	Remark	Qty	Model
-	925 301 191 02	0,15 MM Gasket		1	
-	999 113 175 40	0,20 MM Shaft sealing ring		1	
-	999 701 084 50	6 X 15 X 6 O-ring		1	
-	999 113 185 40	25,3 X 2,4 Shaft sealing ring		1	
-	925 301 392 00	15 X 24 X 7 Gasket		1	
-	900 123 007 30	Sealing ring		1	
-	999 701 376 40	14 X 18 O-ring		1	
-	999 701 359 40	170 X 3,5 O-ring		1	
-	915 116 911 00	40 X 1,5 Repair kit Clutch Comprising: Pressure plate		1	SC
-	930 116 911 00	Clutch plate Clutch release bearing Repair kit Clutch Comprising: Pressure plate		1	TURBO
-	930 116 911 01	Clutch plate Clutch release bearing Repair kit Clutch Comprising: Pressure plate Clutch plate Clutch release bearing		1	TURBO

Model: 911 78

Model life 1978>>1983

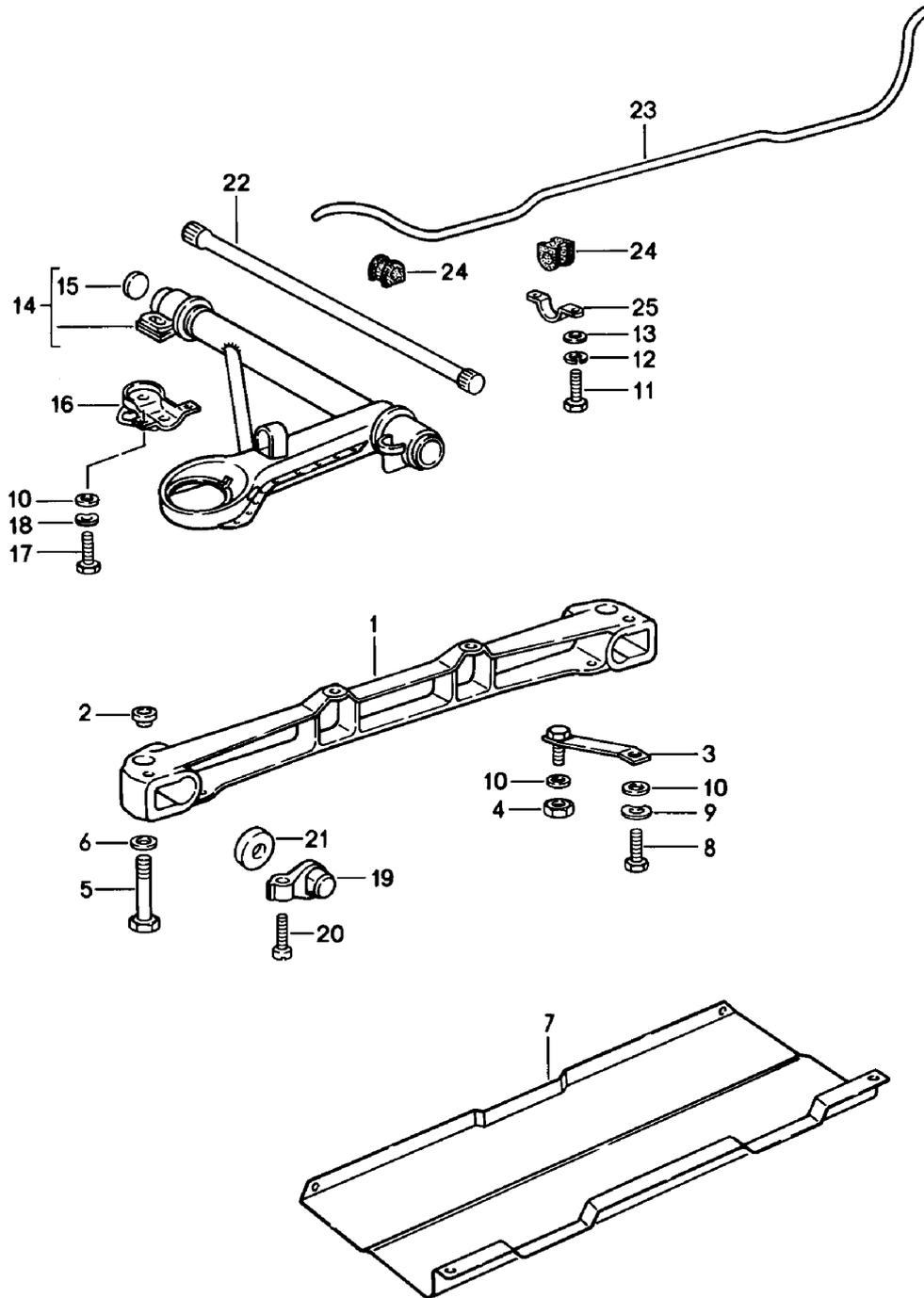

Model: 911 78

Model life 1978>>1983

Pos	Part Number	Description	Remark	Qty	Model
		Front axle			
		Stabiliser			
1	911 341 013 10	Auxiliary support		1	
2	930 341 135 00	Adapter		2	TURBO
3	930 341 031 02	Strut		2	TURBO
3	911 341 031 01	Strut		2	SC
4	900 910 031 09	Lock nut		2	
4	900 910 031 01	Lock nut		2	
5	900 082 110 02	Hexagon-head bolt		2	
		M 12 X 1,5 X 85			
5		Hexagon-head bolt		2	
		M 12 X 1,5 X 85			
6	900 028 014 02	Washer		2	
		B 12			
6	900 028 014 03	Washer		2	
		B 12			
7	930 341 021 02	Protective plate		1	TURBO
7	911 341 161 04	Protective plate		1	SC
7	911 341 161 05	Protective plate		1	SC
8	N 014 721 2	Pan-head screw		2	
		M 10 X 25			
9	N 012 028 1	Lock ring		2	
		B 10			
10	900 025 008 09	Washer		8	
		10,5			
10	900 025 008 04	Washer		8	
		10,5			
11	900 075 087 02	Hexagon-head bolt		2	TURBO
		M 8 X 16			
11	900 075 087 03	Hexagon-head bolt		2	TURBO
		M 8 X 16			
12	900 027 015 02	Lock ring		2	TURBO
		B 8			
12	900 027 015 03	Lock ring		2	TURBO
		B 8			
12	900 027 015 02	Lock ring		2	TURBO
		B 8			
12	900 027 015 03	Lock ring		2	TURBO
		B 8			
13	900 025 007 02	Washer		2	TURBO
		8,4			
13	900 025 007 03	Washer		2	TURBO
		8,4			
14	911 341 901 01	Wishbone	/L	1	SC
14	911 341 902 01	Wishbone	/R	1	SC
14	930 341 901 01	Wishbone	/L	1	TURBO
14	930 341 902 01	Wishbone	/R	1	TURBO
15	900 040 008 01	Lid		2	
16	911 341 037 02	Protective bracket	/L	1	
16	901 341 159 00	Protective bracket	/R	1	
17	N 010 275 3	Hexagon-head bolt		6	SC
		M 10 X 35			
17	900 075 460 01	Hexagon-head bolt		6	SC
		M 10 X 35			
17	N 040 281 1	Hexagon-head bolt		6	TURBO
		M 10 X 45			
17	900 075 516 01	Hexagon-head bolt		6	TURBO
		M 10 X 45			
18	900 027 016 02	Lock ring		6	
		B 10			
18	900 027 016 03	Lock ring		6	
		B 10			
19	901 341 033 00	Reverse lever		2	

Model: 911 78

Model life 1978>>1983

Pos	Part Number	Description	Remark	Qty	Model
20	911 341 115 00	Adjusting screw		2	
21	901 341 475 00	Gasket		2	
22	901 343 101 12	Torsion bar	/L	1	
22	901 343 101 14	Torsion bar	/L	1	
22	901 343 102 12	Torsion bar	/R	1	
22	901 343 102 14	Torsion bar	/R	1	
23	911 343 703 10	Stabiliser 20 MM		1	
24	911 343 792 03	Stabiliser mounting 20 MM		4	
25	911 343 775 00	Clip		2	

Model: 911 78

Model life 1978>>1983

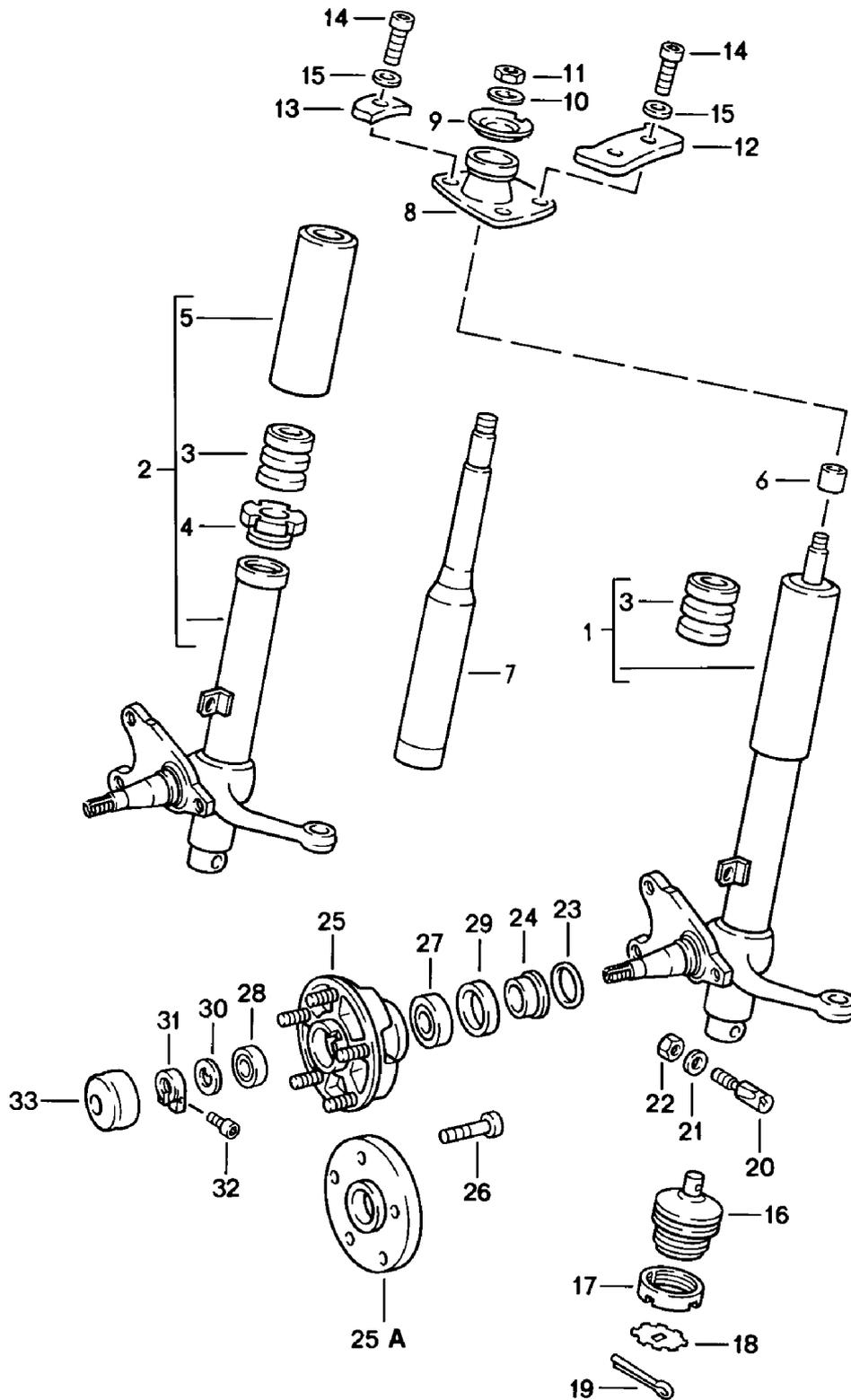

Model: 911 78

Model life 1978>>1983

Pos	Part Number	Description	Remark	Qty	Model
-	PCG 043 110 00	Shock absorber strut Lubricants Grease Bearing 200 GR.		1	
1	911 341 041 33	Shock absorber strut - bilstein -	/L	1	
(1)	911 341 042 33	Shock absorber strut - bilstein -	/R	1	
2	911 341 043 02	Shock absorber strut Outer part - boge -	/L	1	
2	911 341 043 04	Shock absorber strut Outer part	/L	1	
2	911 341 044 02	Shock absorber strut Outer part - boge -	/R	1	
3	901 343 301 00	Rubber stop - boge -		2	SC
4	911 341 804 00	Screw plug Inner Threaded ring - boge -		2	SC
4	911 341 804 01	Screw plug Inner Threaded ring - boge -		2	SC
5	911 341 805 01	Protective tube - boge -		2	SC
6	911 341 615 00	Spacer	-82	2	
7	911 341 913 03	Repair set - boge -		2	SC
7	911 341 913 09	Repair set for Shock absorber strut in pairs Use Attention Deleted 90134330100 POSITION 3		2	SC
8	911 341 018 00	Supporting mount		2	
9	901 341 629 00	Support washer		2	
10	900 038 002 01	Tab washer 14		2	
11	N 011 021 3	Hexagon nut M 14 X 1,5		2	
12	911 501 933 00	Double-bore pressure plate		2	
13	911 501 934 00	One-bore pressure plate		2	
14	900 067 063 02	Pan-head screw M 10 X 20		6	
15	999 523 103 01	Schnorr retainng washer		6	
16	911 341 049 01	Ball joint		2	
16	911 341 049 05	Ball joint		2	
17	901 341 425 00	Grooved nut		2	
17	901 341 425 01	Grooved nut		2	
18	901 341 426 00	Tab washer		2	
19	N 012 521 1	Cotter pin		2	
19		Cotter pin		2	
20	911 341 119 06	Threaded pin		2	
20	911 341 119 07	Threaded pin		2	
21	900 089 006 02	Washer 8		2	

Model: 911 78 Model life 1978>>1983

Pos	Part Number	Description	Remark	Qty	Model
21	900 089 006 01	Washer 8		2	
22	999 084 019 02	Lock nut		2	
23	999 701 084 50	O-ring OR 25,3 - 2,4		2	
24	901 341 623 00	Spacer ring		2	
25	911 341 065 06	Front wheel hub		2	SC
25	911 341 065 10	Front wheel hub		2	SC
25	930 341 065 00	Front wheel hub	-80	2	TURBO
25	930 341 065 01	Front wheel hub	81-	2	TURBO
25A	477 501 701	Spacer ring	-80	2	TURBO
26	911 331 671 00	Wheel bolt		10	TURBO
26	904 341 671 00	Wheel bolt		10	SC
26	993 331 671 02	Wheel bolt		10	SC
26	901 341 671 05	Wheel bolt Oversize		X	
-	PCG 059 065 00	Bearing set Wheel hub Front axle Comprising:		1	
-	999 059 065 00	Taper roller bearing		2	
-	999 059 098 00	Taper roller bearing		2	
-	900 075 079 02	Hexagon-head bolt		10	
-	900 076 064 02	Hexagon nut		10	
-	901 341 623 00	Spacer ring		2	
-	477 405 641	Radial sealing ring		2	
-	999 701 084 50	O-ring		2	
-	N 012 241 8	Spring washer		10	
-	PCG 043 110 00	Grease Bearing 200 GR.		1	
27	999 059 098 00	Taper roller bearing		2	
28	999 059 065 00	Taper roller bearing		2	
29	477 405 641	Radial sealing ring		2	
30	911 341 663 00	Thrust washer		2	
31	911 341 673 00	Clamping nut		2	
32	999 119 001 01	Pan-head screw		2	
32	999 119 001 0B	Pan-head screw		2	
33	911 341 684 00	Cap		2	SC
33		Cap	-80	2	TURBO
33	930 341 066 01	Cap	81-	2	
33	930 341 066 02	Cap	81-	2	
33	930 341 066 01	Cap	81-	2	TURBO
33	930 341 066 02	Cap	81-	2	TURBO

Model: 911 78

Model life 1978>>1983

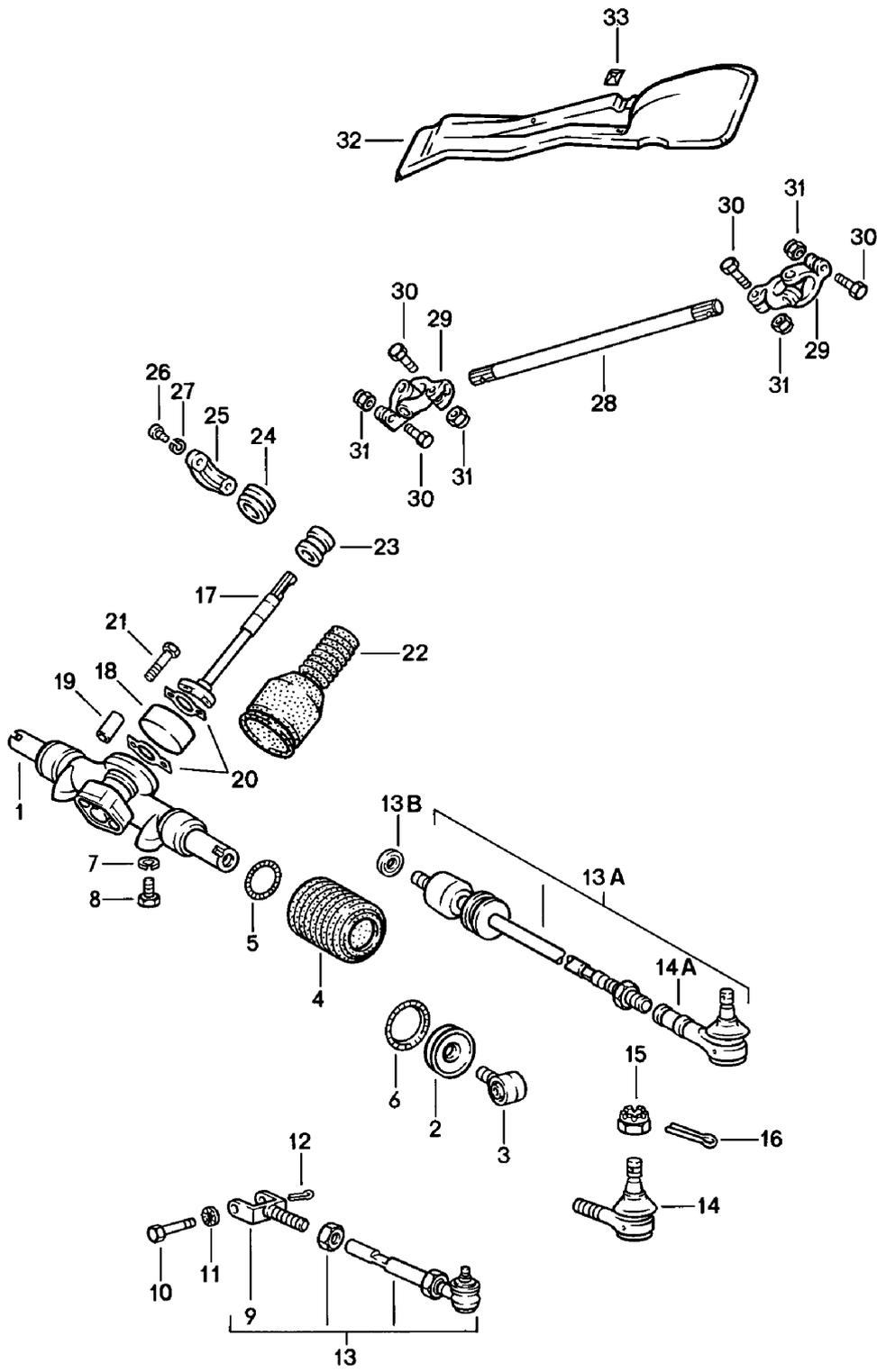

Model: 911 78 Model life 1978>>1983

Pos	Part Number	Description	Remark	Qty	Model
		Steering Accessories Lower			
1	914 347 010 06	Steering gear		1	SC
(1)	930 347 010 00	Steering gear		1	TURBO
(1)	930 347 010 X	Steering gear		1	TURBO
2	911 347 056 00	Bellow support		2	SC
3	914 347 057 00	Articulated bush		2	SC
4	901 347 191 02	Bellows		2	SC
4	930 347 191 02	Bellows		2	TURBO
5	901 347 308 00	Retainer spring		2	SC
6	901 347 309 00	Retainer spring		2	SC
7	900 027 016 02	Lock ring B 10		2	SC
7	900 027 016 03	Lock ring B 10		2	SC
7	900 027 016 02	Lock ring B 10		2	SC
7	900 027 016 03	Lock ring B 10		2	SC
7	900 028 032 02	Spring washer B 10		2	TURBO
(7)	900 025 008 09	Washer B 10		2	TURBO
(7)	900 025 008 04	Washer B 10		2	TURBO
8	N 010 275 3	Hexagon-head bolt M 10 X 35		2	SC
8	900 075 460 01	Hexagon-head bolt M 10 X 35		2	SC
8	N 010 275 3	Hexagon-head bolt M 10 X 35 F >>91182 11528 F >>91182 01444 F >>91183 09716 F >>91183 01515 F >>91183 11134		2	SC
8	900 075 460 01	Hexagon-head bolt M 10 X 35 F >>91182 11528 F >>91182 01444 F >>91183 09716 F >>91183 01515 F >>91183 11134		2	SC
8	900 075 071 07	Hexagon-head bolt M 10 X 45 F 91182 11529>> F 91182 01445>> F 91183 09717>> F 91183 01516>> F 91183 11135>>		2	SC
8	N 010 275 3	Hexagon-head bolt M 10 X 35		2	TURBO
8	900 075 460 01	Hexagon-head bolt M 10 X 35		2	TURBO
9	901 347 315 01	Joint fork		2	SC
9	901 347 315 03	Joint fork		2	SC
10	911 347 327 00	Hexagon-head bolt		2	SC
11	999 523 103 01	Schnorr retainng washer M 10		2	SC
12	900 021 008 00	Cotter pin 2 X 15		2	SC
12	900 021 008 0A	Cotter pin		2	SC

Model: 911 78 Model life 1978>>1983

Pos	Part Number	Description	Remark	Qty	Model
13	911 347 031 00	2 X 15 Tie rod		2	SC
13	911 347 031 01	Tie rod		2	SC
13A	930 347 031 01	Tie rod		2	TURBO
13B	930 347 313 01	Washer		2	TURBO
13B	930 347 313 02	Washer		2	TURBO
14	911 347 322 04	Ball joint		2	SC
14A	930 347 322 00	Ball joint		2	TURBO
15	N 011 210 1	Castle nut M 10 X 1		2	
16	900 021 013 00	Cotter pin 2 X 25		2	
17	901 347 210 03	Steering shaft		1	
17	901 347 210 04	Steering shaft		1	
18	901 347 201 02	Steering coupling		1	
19	901 347 215 00	Stop bush		2	
20	901 347 248 00	Tab washer		1	
21	N 010 353 3	Hexagon-head bolt M 8 X 42		2	
21		Hexagon-head bolt M 8 X 42		2	
22	901 347 393 01	Sealing bellows		1	
22	901 347 393 02	Sealing bellows		1	
23	911 347 041 00	Steering shaft bearing		1	
23	911 347 029 01	Steering shaft bearing Complete		1	
-	911 347 029 00	Needle-roller bearing		1	
-	911 347 029 01	Steering shaft bearing		1	
24	901 347 223 03	Rubber mounting		1	
25	901 347 221 00	Housing		1	
25	901 347 221 01	Housing		1	
26	900 186 002 02	Pan-head screw M 8 X 15		2	
27	900 142 002 01	Lock ring 8		2	
28	911 347 211 01	Intermed. steering shaft	/LL	1	
(28)	911 347 212 01	Intermed. steering shaft	/RL	1	
29	930 347 025 00	Universal joint		2	
29	930 347 025 01	Universal joint		2	
29	930 347 025 02	Universal joint		2	
29	930 347 025 00	Universal joint		2	
29	930 347 025 01	Universal joint		2	
29	930 347 025 02	Universal joint		2	
30	N 010 335 5	Hexagon-head bolt		4	
30	900 075 032 03	Hexagon-head bolt		4	
30	N 010 335 5	Hexagon-head bolt M 8 X 35		4	
30	900 075 032 03	Hexagon-head bolt M 8 X 35		4	
31	N 021 194 1	Lock nut M 8		4	
32	901 347 067 00	Cover	/LL	1	
(32)	901 347 068 00	Cover	/RL	1	
33	999 507 209 01	Speed nut		2	

Model: 911 78

Model life 1978>>1983

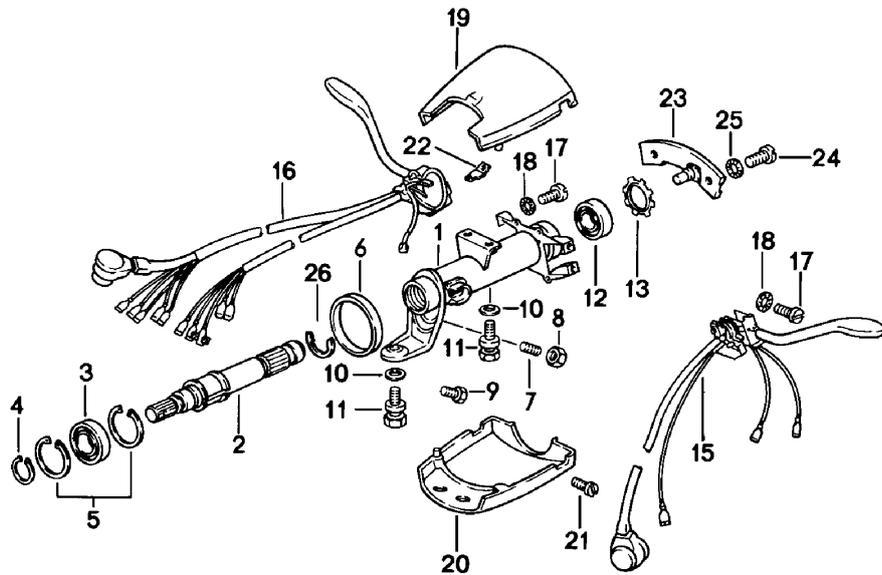
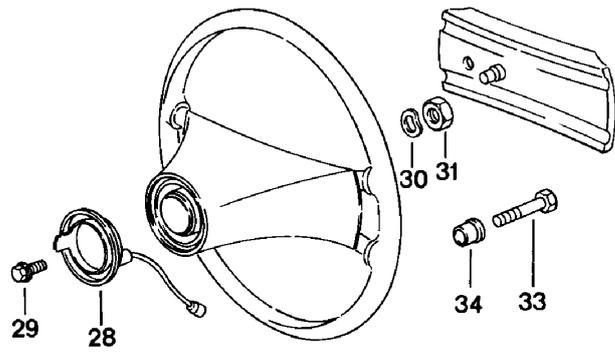
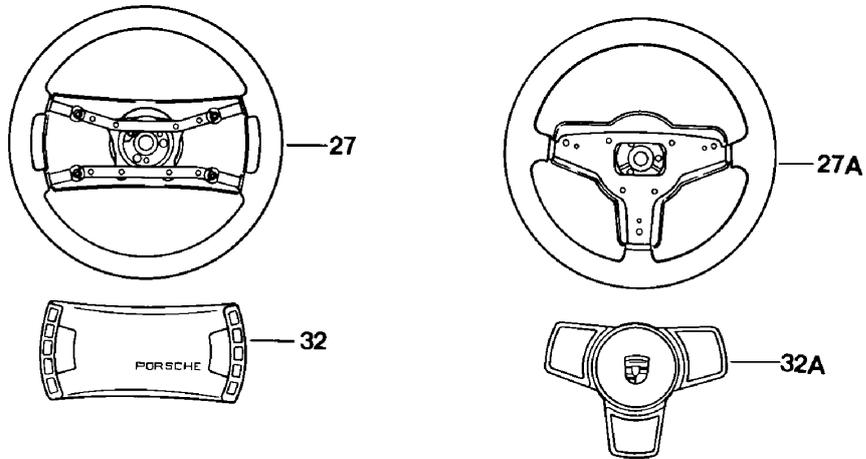

Model: 911 78

Model life 1978>>1983

Pos	Part Number	Description	Remark	Qty	Model
		Steering Accessories Upper			
1	911 347 073 03	Steering outer tube	/LL	1	
(1)	911 347 072 04	Steering outer tube	/RL	1	
(1)		Steering outer tube	/RL	1	
2	911 347 061 02	Steering shaft		1	
3	900 052 031 00	Deep-groove ball bearing		1	
4	900 041 008 00	Circlip 17 X 1		1	
5	900 042 008 00	Circlip 35 X 1,5		2	
6	911 347 713 00	Gasket		1	
7	900 228 002 02	Threaded pin M 8 X 16	/LL	1	
8	900 076 025 02	Hexagon nut M 8	/LL	1	
8	900 076 064 02	Hexagon nut M 8	/LL	1	
9	900 146 044 02	Oval-head screw AM 6 X 10	/RL	1	
10	N 012 241 8	Spring washer B 8		3	
11	901 347 753 00	Shear bolt		3	
12	911 347 771 02	Ball bearing		1	
13	999 041 102 01	Circlip		1	
15		Direction indicator switch SIEHE 9/03/10			
16		Wiper switch SIEHE 9/03/10			
17	900 014 069 02	Pan-head screw AM 3 X 8		8	
18	900 115 007 01	Serrated lock washer A 3,2		8	
19	911 613 099 00	Switch housing Upper part		1	
20	911 613 312 00	Switch housing Lower part		1	
20	911 613 312 03	Switch housing Lower part		1	
-	911 613 328 00	Switch housing Set Comprising: Upper part/lower part POSITION 19 + 20		1	
21	900 014 079 02	Pan-head screw AM 3 X 10		2	
22	999 652 315 02	Flat plug		1	
23	911 613 521 00	Wiper contact		1	
24	900 014 046 02	Pan-head screw M 4 X 10		2	
25	N 012 116 1	Serrated lock washer A 4,3		2	
26	113 415 531	Circlip		1	
27	911 347 083 00	Safety steering wheel 400 \$	-79	1	SC
27	911 347 083 70	Safety steering wheel Leather	-79	1	SC
27A	911 347 084 02	Sports steering wheel		1	
	911 347 084 02 1AJ	Black			
	911 347 084 02 2LB	Burgundy			
27A	911 347 084 07	Steering wheel		1	M018
	911 347 084 07 1AJ	Black			

Model: 911 78

Model life 1978>>1983

Pos	Part Number	Description	Remark	Qty	Model
28	911 347 099 05	Slip ring		1	
29	900 146 029 02	Oval-head screw AM 3,5 X 10		7	
29	113 415 869	Oval-head screw AM 3,5 X 10		7	
30	N 012 239 1	Spring washer B 18		1	
31	900 078 007 02	Hexagon nut M 18 X 1,5		1	
32	911 347 097 00	Padded cap	-79	1	SC
	911 347 097 00 70B	Black			
32A	911 347 859 00	Padded cap		1	
	911 347 859 00 70B	Black			
	911 347 859 00 2LB	Burgundy			
33	N 010 261 3	Hexagon-head bolt M 4 X 16		X	
34	321 419 779	Insulating bush		X	

Model: 911 78

Model life 1978>>1983

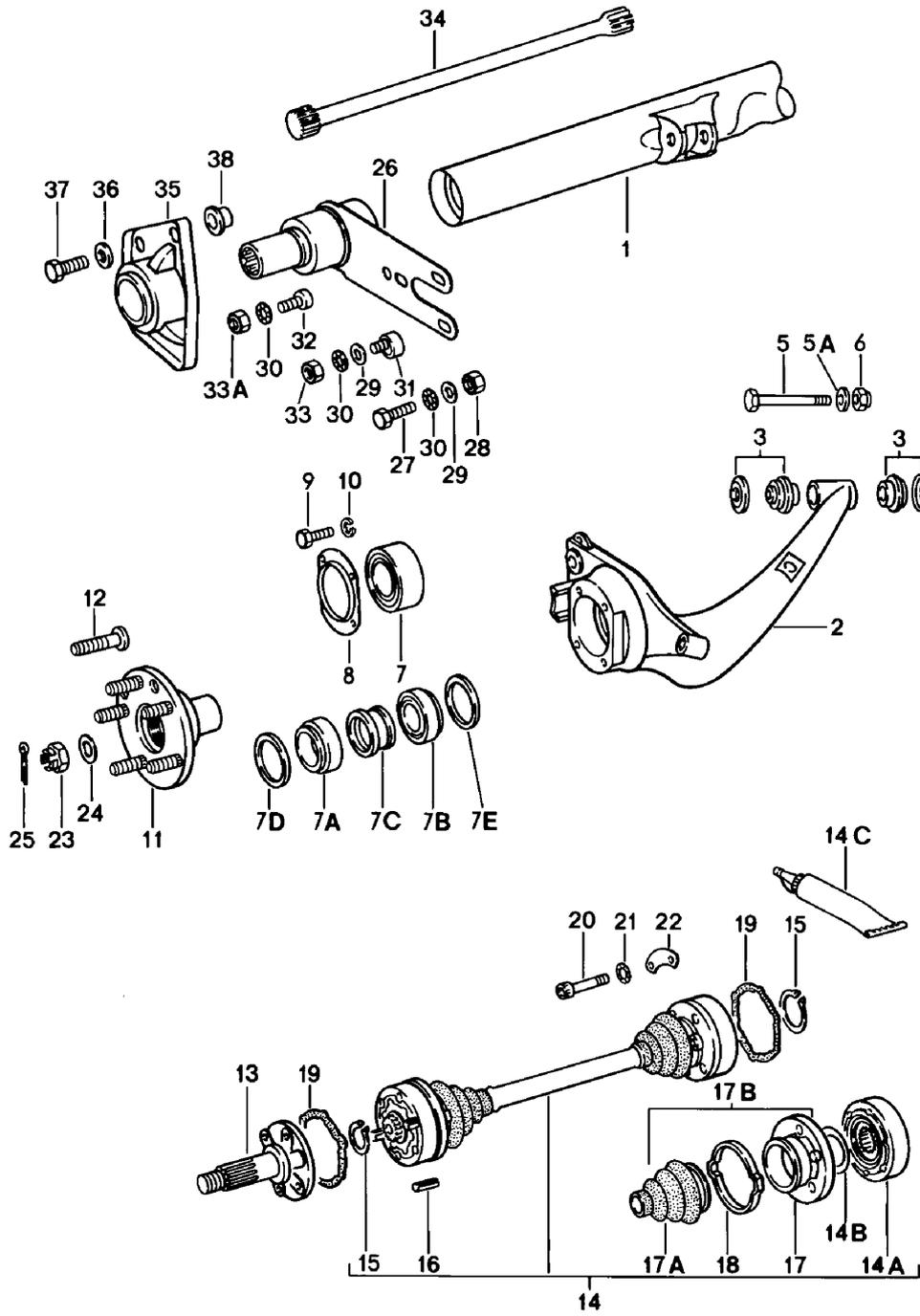

Model: 911 78 Model life 1978>>1983

Pos	Part Number	Description	Remark	Qty	Model
(1)	911 331 010 02	Rear axle		1	SC
(1)	930 331 010 02	Rear-axle cross-tube		1	TURBO
(1)	930 331 010 02 GRV	Rear-axle cross-tube Prime coated		1	TURBO
					M491
2	911 331 513 06	Rear-axle trailing arm	/L	1	SC
(2)	911 331 514 06	Rear-axle trailing arm	/R	1	SC
(2)	930 331 511 05	Rear-axle trailing arm	/L	1	TURBO
(2)	930 331 511 06	Rear-axle trailing arm	/L	1	TURBO
(2)	930 331 512 05	Rear-axle trailing arm	/R	1	TURBO
(2)	930 331 512 06	Rear-axle trailing arm	/R	1	TURBO
3	901 331 059 00	Flange mounting		4	
5	900 082 064 02	Hexagon-head bolt M 14 X 1,5 X 75		2	SPM
5	900 082 064 08	Hexagon-head bolt M 14 X 1,5 X 75		2	SPM
5	900 082 092 02	Hexagon-head bolt M 14 X 1,5 X 80		2	
5A	N 011 534 4	Washer A 15		2	
6	999 084 014 02	Hexagon nut M 14 X 1,5		2	
6	900 910 094 02	Lock nut M 14 X 1,5		2	
7	999 053 020 01	Angular-contact bearing		2	SC
-	PCG 930 059 00	Set of bearings		1	TURBO
		Rear axle Comprising: POS. 7A-E; 23; 25			
7A	999 059 056 00	Taper roller bearing		2	TURBO
7B	999 059 047 00	Taper roller bearing		2	TURBO
7C	930 331 609 00	Spacer sleeve		2	TURBO
7D	999 113 235 40	Shaft sealing ring 65 X 85 X 8		2	TURBO
7E	999 113 218 40	Shaft sealing ring 58 X 81,2 X 5		2	TURBO
8	911 331 561 30	Reinforcement cover		2	SC
9	900 075 079 02	Hexagon-head bolt M 8 X 22		8	SC
9		Hexagon-head bolt M 8 X 22		8	SC
10	900 027 015 02	Lock ring B 8		8	SC
10	900 027 015 03	Lock ring B 8		8	SC
11	911 331 065 33	Rear-wheel hub		2	SC
11	930 331 065 03	Rear-wheel hub		2	TURBO
12	904 341 671 00	Wheel bolt		10	SC
12	993 331 671 02	Wheel bolt		10	SC
12	901 331 671 01	Wheel bolt		10	TURBO
13	923 332 232 01	Drive shaft		2	SC
13	901 332 232 00	Drive shaft		2	SC/SPM
13	930 332 232 00	Drive shaft		2	TURBO
14	923 332 033 02	Drive shaft		2	SC
14	911 332 033 08	Drive shaft		2	SC/SPM
14	911 332 033 09	Drive shaft		2	SC/SPM
14	930 332 037 00	Drive shaft		2	TURBO
14A	923 332 032 00	Joint		4	SC
14A	911 332 032 02	Joint		2	SC/SPM
14A	930 332 034 00	Joint		4	TURBO
14B	901 332 311 10	Cup spring		4	SC
14B	901 332 312 00	Cup spring		4	TURBO

Model: 911 78

Model life 1978>>1983

Pos	Part Number	Description	Remark	Qty	Model
14C	000 043 005 00	Grease		X	
15	999 041 016 01	Circlip		4	SC
15	999 041 012 01	Circlip		8	SC/SPM
15	999 152 084 01	Circlip		4	TURBO
16	999 095 019 00	Clamping pin S 10 X 20		8	SC/SPM
17	911 332 295 02	Protection cap		4	SC/SPM
17	911 332 295 03	Protection cap		4	SC/SPM
17	928 332 097 00	Joint flange		4	TURBO
17	928 332 097 03	Joint flange		4	TURBO
17A	901 332 293 12	Dust bellows		4	
17B	923 332 037 00	Dust bellows		4	SC
18	999 512 315 02	Clamp		4	
18	999 512 486 00	Clamp		4	
19	901 332 297 00	Gasket		2	SC/SPM
19	923 332 297 00	Gasket		2	SC
19	930 332 297 00	Gasket		4	TURBO
20	900 067 229 09	Pan-head screw M 10 X 48		16	SC/SPM
20	900 067 211 09	Pan-head screw M 8 X 50		24	SC
20	900 067 118 01	Pan-head screw M 10 X 60		24	TURBO
21	999 523 103 01	Schnorr retainng washer M 10		8	SC/SPM
22	911 332 191 00	Plate		4	SC/SPM
23	901 332 806 00	Castle nut		2	
23	901 332 806 01	Castle nut		2	
24	999 025 046 01	Washer		2	
25	N 012 538 1	Cotter pin 4 X 40		2	
25		Cotter pin 4 X 40		2	
26	911 333 009 00	Rear axle strut		2	
26	911 333 009 05	Rear axle strut		2	
-	900 910 092 02	Lock nut		4	
-	900 360 007 01	Lock nut		4	
-	911 331 107 01	Spacer ring		2	
-	911 333 303 00	Eccentric screw		2	
-	911 333 303 01	Eccentric screw		2	
-	911 333 305 00	Hexagon-head bolt		2	
-	911 333 305 01	Hexagon-head bolt		2	
-	911 333 307 00	Washer		4	
-	911 333 307 02	Washer		4	
-	900 075 043 02	Hexagon-head bolt M 10 X 30		8	
-		Hexagon-head bolt M 10 X 30		8	
27	900 083 019 08	Hexagon-head bolt M 12 X 1,5 X 35		4	
27	900 083 066 08	Hexagon-head bolt M 12 X 1,5 X 40	83-	4	
28	N 011 020 8	Hexagon nut M 12 X 1,5		4	
28	900 034 036 01	Hexagon nut M 12 X 1,5		4	
28	N 011 020 8	Hexagon nut M 12 X 1,5		4	
28	900 034 036 01	Hexagon nut M 12 X 1,5		4	
28	N 022 141 4	Lock nut VFM 12 X 1,5	83-	4	
28		Lock nut	83-	4	

Model: 911 78

Model life 1978>>1983

Pos	Part Number	Description	Remark	Qty	Model
29	901 333 143 01	M 12 X 1,5 Washer		10	
30	999 523 109 02	Lock washer M 12		10	
31	901 333 133 04	Eccentric		2	
31	901 333 133 06	Eccentric		2	
32	901 333 133 05	Eccentric		2	
33	900 078 017 02	Hexagon nut M 12 X 1,5		2	
33A	900 076 016 02	Hexagon-head bolt M 12 X 1,5		2	
34	911 333 101 09	Torsion bar 24,1 MM	/L	1	SC
34	911 333 101 16	Torsion bar 24,1 MM New design Only together with 91133310216 Use	/L /R	1	SC
34	911 333 102 09	Torsion bar 24,1 MM	/R	1	SC
34	911 333 102 16	Torsion bar 24,1 MM New design Only together with 91133310116 Use	/R /L	1	SC
34	911 333 101 03	Torsion bar 26 MM	/L	1	TURBO
34	911 333 101 13	Torsion bar 26 MM New design Only together with 91133310213 Use	/L /R	1	TURBO
34	911 333 102 03	Torsion bar 26 MM	/R	1	TURBO
34	911 333 102 13	Torsion bar 26 MM New design Only together with 91133310113 Use	/R /L	1	TURBO
35	901 333 153 00	Housing		2	
36	900 025 008 02	Washer 10,5		8	
36	900 025 008 09	Washer 10,5		8	
36	900 025 008 04	Washer 10,5		8	
37	900 075 043 02	Hexagon-head bolt M 10 X 30		8	
37		Hexagon-head bolt M 10 X 30		8	
38	911 331 107 01	Spacer ring		2	

Model: 911 78

Model life 1978>>1983

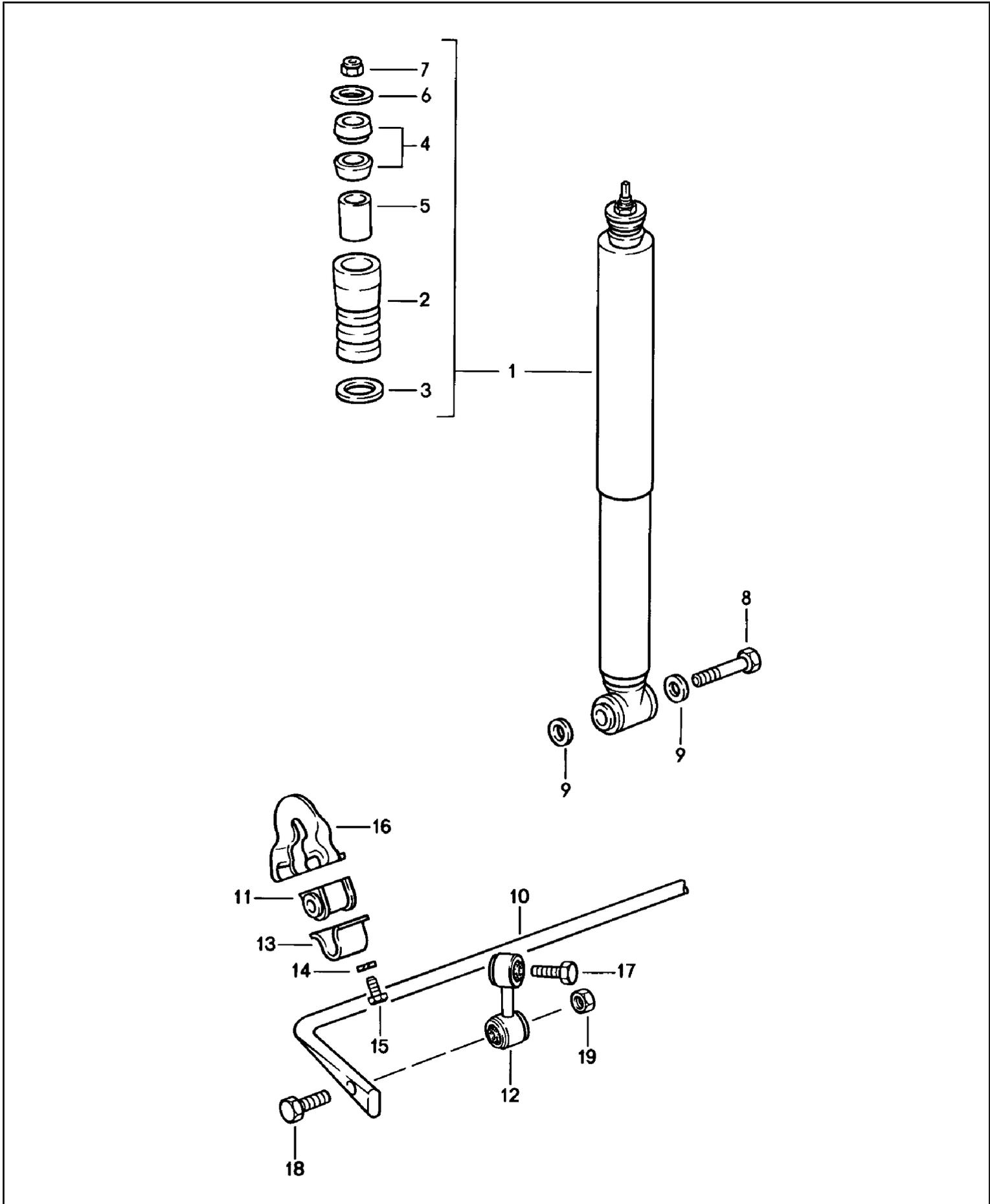

Model: 911 78 Model life 1978>>1983

Pos	Part Number	Description	Remark	Qty	Model
1	911 333 051 03	Vibration damper Stabiliser Vibration damper - boge - F >>91183 01907 F >>91183 11407		2	SC
1	911 333 051 05	Vibration damper - boge - F 91183 01908>> F 91183 11408>>		2	SC
1	911 333 051 16	Vibration damper F 91183 01908>> F 91183 11408>>		2	SC
1	911 333 051 49	Vibration damper		2	
1	911 333 051 60	Vibration damper - bilstein -		2	
2	911 333 301 04	Additional spring		2	
3	911 333 511 00	Washer		2	TURBO
4	911 333 521 00	Rubber mounting		4	
5	911 333 522 00	Articulated bush		2	
6	911 333 523 00	Washer		4	
6		Washer - woodhead -	-79	4	SC
7	900 084 013 02	Lock nut M 10 X 1		2	
8	900 082 054 02	Hexagon-head bolt M 14 X 1,5 X 85		2	SC
8	900 082 051 01	Hexagon-head bolt M 14 X 1,5 X 90		2	TURBO
9	999 025 062 02	Washer		2	SC
9		Washer		4	TURBO
10	911 333 701 07	Stabiliser 18 MM		1	SC
10	930 333 701 23	Stabiliser 18 MM		1	TURBO
11	477 411 313 B	Stabiliser mounting		2	
11	477 411 313 N	Stabiliser mounting		2	
12	930 333 071 00	Stabiliser mounting	/L	1	
12	930 333 071 01	Stabiliser mounting	/L	1	
(12)	930 333 072 00	Stabiliser mounting	/R	1	
(12)	930 333 072 01	Stabiliser mounting	/R	1	
13	113 411 333	Retaining bar		2	
14	900 027 015 02	Lock ring B 8		4	
14	900 027 015 03	Lock ring B 8		4	
14	900 027 015 02	Lock ring B 8		4	
14	900 027 015 03	Lock ring B 8		4	
15	N 010 239 11	Hexagon-head bolt M 8 X 18		4	
15	N 010 239 30	Hexagon-head bolt M 8 X 18		4	
15	N 010 239 11	Hexagon-head bolt M 8 X 18		4	
15	N 010 239 30	Hexagon-head bolt M 8 X 18		4	
16	911 501 180 02	Bracket		2	
16	911 501 983 00	Bracket		2	
16		Bracket		2	
	911 501 983 00 GRV	Prime coated		2	
17	N 010 156 3	Hexagon-head bolt		2	

Model: 911 78

Model life 1978>>1983

Pos	Part Number	Description	Remark	Qty	Model
17		M 12 X 1,5 X 70 Hexagon-head bolt		2	
18	900 082 035 02	M 12 X 1,5 X 70 Hexagon-head bolt		2	
19	900 910 046 02	M 12 X 1,5 X 60 Lock nut VM 12 X 1,5		2	
19	999 084 439 09	Lock nut VM 12 X 1,5		2	
19	999 084 445 09	Lock nut VM 12 X 1,5		2	
19	999 084 445 01	Lock nut VM 12 X 1,5		2	

Model: 911 78

Model life 1978>>1983

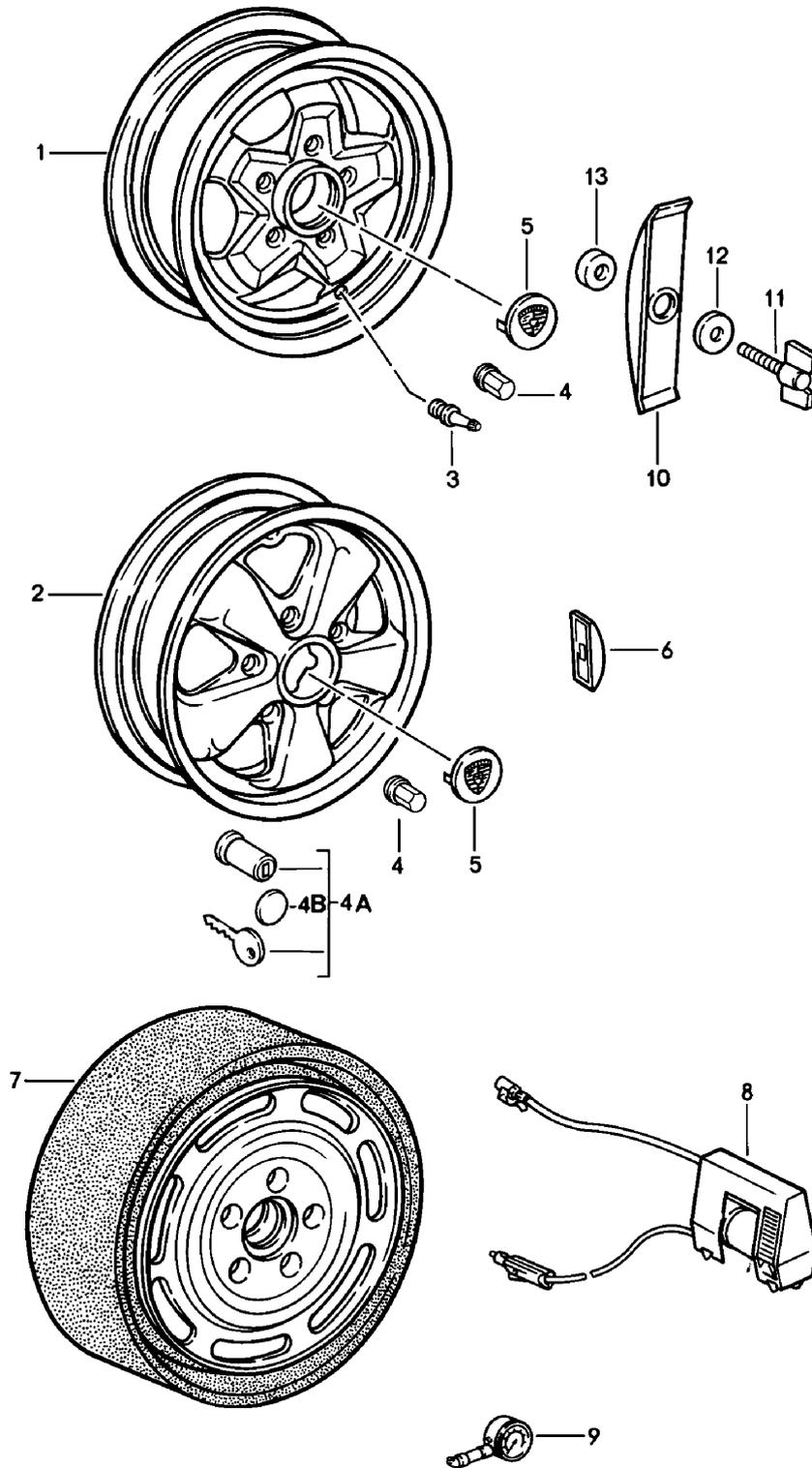

Model: 911 78 Model life 1978>>1983

Pos	Part Number	Description	Remark	Qty	Model
1	911 361 023 44	Wheels Perforated disc wheel 6J X 15 ET = 36,0 Unvarnished		2	SC
1	911 361 023 40	Alloy wheel 6J X 15 ET = 36,0 Silver Lacquered	-81	2	SC
(1)	911 361 023 93	Alloy wheel 6J X 15 ET = 36,0 Silver *		2	SC
1	911 361 023 45	Alloy wheel 6J X 15 ET = 36,0 Black Lacquered	82-	2	SC
-	911 361 021 00	Perforated disc wheel 6J X 15 ET = 36,0 Steel Silver Winter wheel		X	SC
1	911 361 023 54	Alloy wheel 7J X 15 ET = 23,3 Unvarnished		2	SC
1	911 361 023 50	Alloy wheel 7J X 15 ET = 23,3 Silver Lacquered	-81	2	SC
(1)	911 361 023 94	Alloy wheel 7J X 15 ET = 23,3 Silver *		2	SC
1	911 361 023 55	Alloy wheel 7J X 15 ET = 23,3 Black Lacquered	82-	2	SC
2	911 362 113 00	Alloy wheel 6J X 16 Black star Rim flange polished		2	SC
2	911 361 020 97	Perforated disc wheel 6J X 16 Unvarnished Rim flange polished		2	SC
2	911 362 113 90	Alloy wheel 6J X 16 Unvarnished Rim flange polished		2	SC
2	911 362 113 00	Alloy wheel 6J X 16 Unvarnished Rim flange polished		2	SC
2	911 362 115 00	Alloy wheel 7J X 16		2	

Model: 911 78

Model life 1978>>1983

Pos	Part Number	Description	Remark	Qty	Model
2	911 362 115 07	Black star Rim flange polished Alloy wheel 7J X 16		2	
2	911 362 115 90	Black star Rim flange polished Alloy wheel 7J X 16 Unvarnished		2	
2	911 362 117 00	Rim flange polished Alloy wheel 8J X 16		2	TURBO
2	911 362 117 03	Black star Rim flange polished Alloy wheel 8J X 16		2	TURBO
2	911 361 020 99	Black star Rim flange polished Perforated disc wheel 8J X 16 Unvarnished		2	TURBO
2	911 362 117 90	Rim flange polished Alloy wheel 8J X 16 Unvarnished		2	TURBO
2	911 362 117 00	Rim flange polished Alloy wheel 8J X 16 Unvarnished		2	TURBO
2	911 362 117 03	Rim flange polished Alloy wheel 8J X 16 Unvarnished		2	TURBO
2	911 361 020 41	Rim flange polished Alloy wheel 7J X 15		2	
2	911 361 020 50	Black star Rim flange polished Alloy wheel 7J X 15		2	
2	911 361 020 42	Black star Rim flange polished Alloy wheel 8J X 15		2	
3	900 265 001 50	Rubber valve		4	
3	900 265 001 51	Rubber valve		4	
-	965 361 561 00	Valve support		2	
4	999 182 003 36	Wheel nut for Alloy wheels		20	
(4)	N 020 112 1	Ball seat nut A 14 for steel rim only		X	SC
4A	928 361 047 03	Wheel nut 1 set Lockable		1	
4A	965 361 955 00	Wheel nut 1 set Lockable		1	
4A	968 361 955 00	Wheel nut 1 set		1	

Model: 911 78 Model life 1978>>1983

Pos	Part Number	Description	Remark	Qty	Model
4A	993 361 057 00	Lockable Wheel nut 1 set		1	
4B	965 361 167 00	Lockable Cap		4	
5	911 361 032 00	Hub cap Silver Lacquered		4	SC
5	911 361 032 01	Hub cap Silver Anodised		4	SC
5	911 361 032 28	Hub cap Black		4	TURBO
5	SOW 911 038 11	Hub cap Black Crest Coloured		4	
6	901 361 410 00	Balance stick-on weight 10 G		X	
6	901 361 411 00	Balance stick-on weight 20 G		X	
6	901 361 412 00	Balance stick-on weight 30 G		X	
6	901 361 413 00	Balance stick-on weight 40 G		X	
6	901 361 414 00	Balance stick-on weight 50 G		X	
6	901 361 415 00	Balance stick-on weight 60 G		X	
6	901 361 416 00	Balance stick-on weight 70 G		X	
6	901 361 417 00	Balance stick-on weight 80 G		X	
7	928 362 030 02	Emergency wheel with collapsible tire		1	
(8)	911 652 052 00	Small electric compressor		1	
(8)	964 652 052 00	Small electric compressor		1	
(8)	964 652 053 00	Compressor		1	
(8)	993 652 053 00	Compressor		1	
(8)	996 652 053 00	Compressor		1	
(8)	997 652 051 00	Compressor		1	
(8)	997 652 055 00	Compressor		1	
-	911 361 511 01	Compressed air bottle		1	
-	996 361 521 00	Boot for Impeller		1	
9	911 722 202 00	Tyre pressure gauge Porsche Classic mit Lederhülle		1	
10	911 361 633 01	Clamping bow		1	
10		Clamping bow		1	
11	999 074 106 02	Wing screw M 8 X 25		1	
12	900 151 008 02	Washer B 8,4		1	
13	803 813 583	Washer		1	

Model: 911 78

Model life 1978>>1983

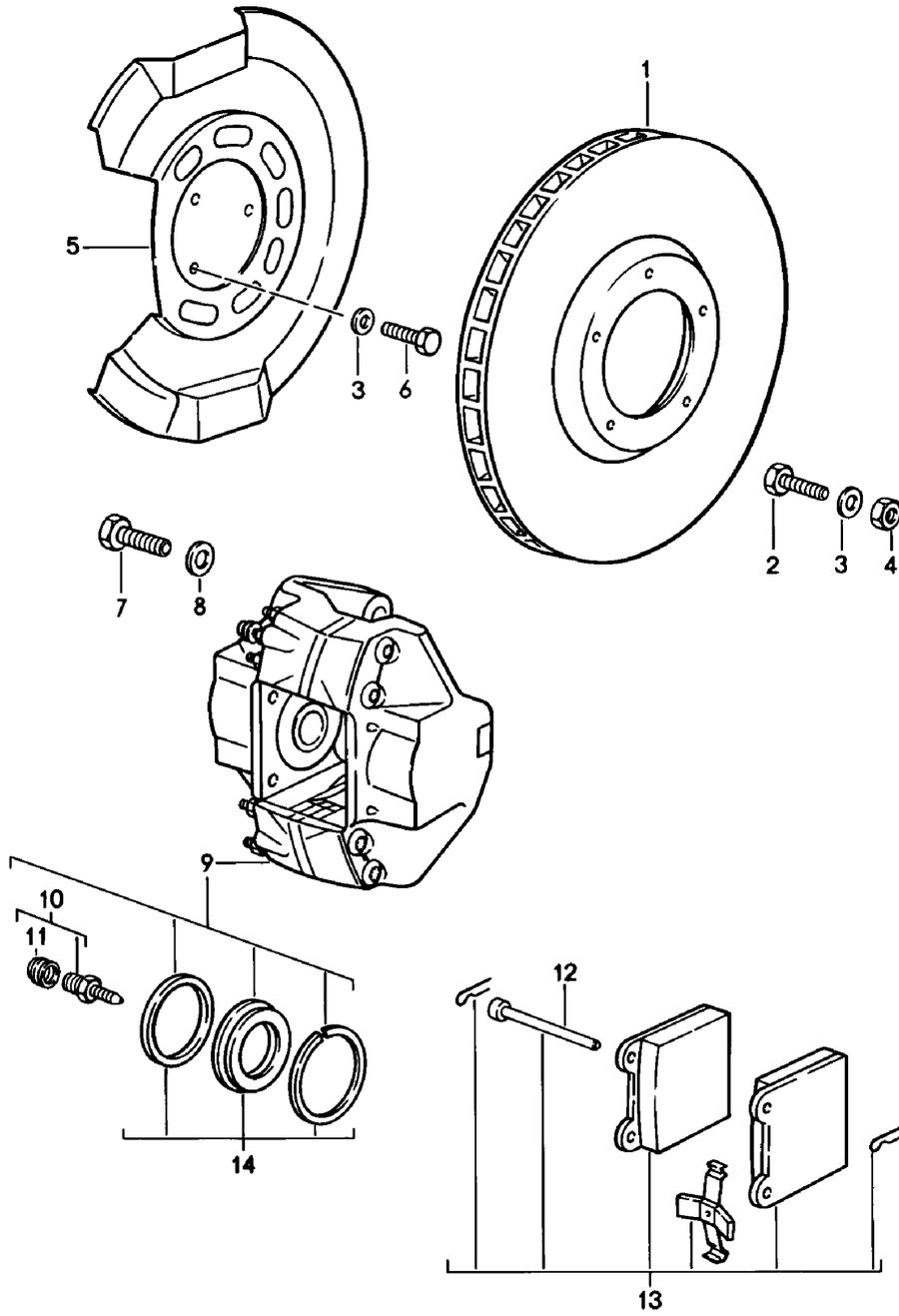

Model: 911 78 Model life 1978>>1983

Pos	Part Number	Description	Remark	Qty	Model
		Disc brake Front axle			SC
1	477 405 083 A	Brake disc		2	
1	477 405 083 D	Brake disc		2	
2	900 075 079 02	Hexagon-head bolt M 8 X 22		10	
3	N 012 241 8	Spring washer B 8		10	
4	900 076 025 02	Hexagon nut M 8		10	
4	900 076 064 02	Hexagon nut M 8		10	
5	901 351 801 17	Protective plate		2	
6	N 010 235 3	Hexagon-head bolt M 8 X 10		6	
7	900 083 023 02	Hexagon-head bolt M 12 X 1,5 X 35		4	
7	900 083 023 03	Hexagon-head bolt M 12 X 1,5 X 35		4	
8	900 028 014 02	Washer B 12		4	
8	900 028 014 03	Washer B 12		4	
9	911 351 425 02	Fixed calliper without pad	/L	1	
9	911 351 426 02	Fixed calliper without pad	/R	1	
10	911 351 919 01	Ventilation valve		2	
11	901 351 927 10	Dust boot		2	
12	911 351 951 00	Parts kit		4	
13	911 351 949 01	Brake pad repair set Complete without asbestos		1	
(13)	911 351 950 01	Brake pad repair set without asbestos		1	
(13)	911 351 950 02	Brake pad repair set without asbestos		1	
(13)	911 351 950 06	Brake pad repair set		1	
(13)	911 351 950 08	Brake pad repair set		1	
(13)	911 351 951 00	Parts kit		1	
14	911 351 946 00	Gasket set		1	

Model: 911 78

Model life 1978>>1983

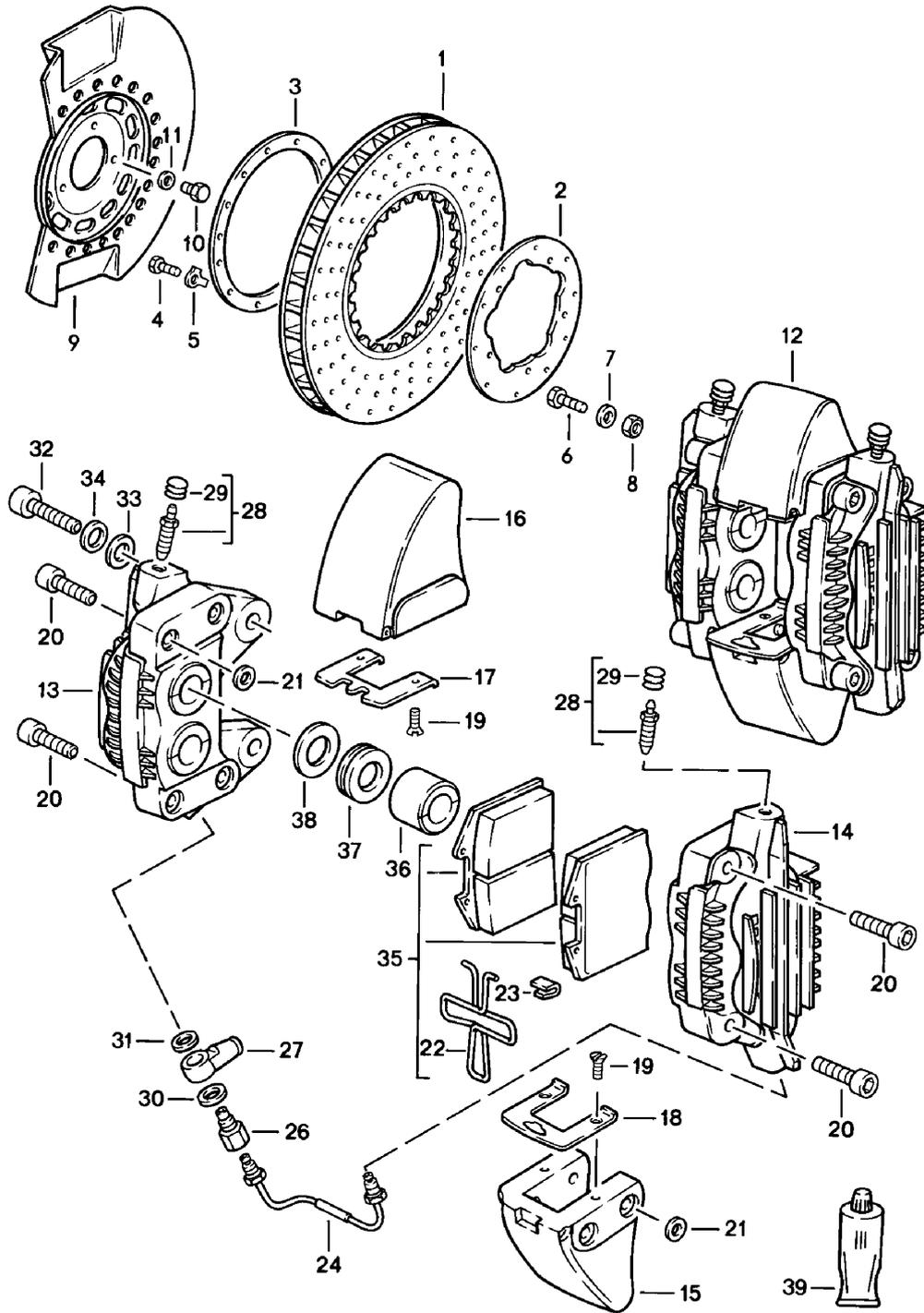

Model: 911 78

Model life 1978>>1983

Pos	Part Number	Description	Remark	Qty	Model
		Disc brake Front axle			TURBO
1	930 351 047 00	Brake disc	/L -80	1	
1	930 351 047 01	Brake disc	/L 81-	1	
(1)	930 351 048 00	Brake disc	/R -80	1	
(1)	930 351 048 01	Brake disc	/R 81-	1	
2	930 351 457 01	Brake flange	-80	2	
3	930 351 423 00	Ring		2	
4	900 075 057 02	Hexagon-head bolt M 6 X 16	-80	24	
4	900 075 057 03	Hexagon-head bolt M 6 X 16		24	
5	900 039 002 02	Tab washer	-80	24	
6	900 075 079 02	Hexagon-head bolt M 8 X 22		10	
7	N 012 241 8	Spring washer B 8 X 15		10	
7		Spring washer B 8		10	
8	900 076 025 02	Hexagon nut M 8		10	
8	900 076 064 02	Hexagon nut M 8		10	
9	930 351 803 01	Protective plate		2	
9		Protective plate		2	
10	N 010 235 3	Hexagon-head bolt M 8 X 10		6	
11	N 012 241 8	Spring washer B 8		6	
12	930 351 091 03	Brake calliper without Brake pad	/L	1	
(12)	930 351 092 03	Brake calliper without Brake pad	/R	1	
13	930 351 951 01	Fixed calliper	/L	1	
13	930 351 952 02	Brake calliper	/L	1	
13	930 351 951 02	Fixed calliper	/L	1	
14	930 351 951 01	Fixed calliper	/R	2	
14	930 351 952 02	Brake calliper	/R	2	
15	930 351 563 02	Bridge 1		2	
15	930 351 563 04	Bridge 1		2	
16	930 351 564 02	Bridge 2		2	
16	930 351 564 03	Bridge 2		2	
17	930 351 541 03	Spring plate 1		2	
18	930 351 542 02	Spring plate 2		2	
19	900 269 017 02	Countersunk-head screw M 5 X 12		8	
20	900 067 170 02	Pan-head screw M 12 X 1,5 X 40		16	
21	930 351 580 01	Spacer sleeve		16	
22	951 352 950 00	Expanding spring		2	
23	930 351 559 00	Tab washer	-79	2	
24	930 355 061 01	F >>93087 00379 F >>93088 00216 F >>93087 09550 Connecting line	/L	1	

Model: 911 78

Model life 1978>>1983

Pos	Part Number	Description	Remark	Qty	Model
24	930 355 061 04	Connecting line	/L	1	
(24)	930 355 061 01	Connecting line	/L	1	
(24)	930 355 061 04	Connecting line	/L	1	
(24)	930 355 062 01	Connecting line	/R	1	
(24)	930 355 062 04	Connecting line	/R	1	
26	914 355 534 00	Banjo bolt		2	
27	914 355 531 00	Ring fitting		2	
28	930 355 517 00	Bleeder screw		4	
28	930 351 919 00	Ventilation valve		1	
29	901 351 927 10	Dust boot		4	
30	900 123 005 20	Sealing ring		2	
		A 12 X 16			
31	N 013 808 3	Sealing ring		2	
		A 10 X 16			
32	900 067 170 02	Pan-head screw		4	
		M 12 X 1,5 X 40			
33	930 351 553 01	Spacer		4	
34	900 028 014 02	Washer		4	
		B 12			
34	900 028 014 03	Washer		4	
		B 12			
34	900 028 014 02	Washer		4	
		B 12			
34	900 028 014 03	Washer		4	
		B 12			
(35)	930 351 938 05	Brake pad repair set		1	
(35)	951 351 939 04	Brake pad repair set		1	
(35)	964 351 939 02	Brake pad repair set		1	
(35)	964 351 939 03	Brake pad repair set		1	
(35)	951 351 939 03	Brake pad repair set without asbestos		1	
36	930 351 551 04	Piston		8	
		38 \$			
37	930 351 547 00	Scraper ring		8	
38	930 351 555 01	Sealing ring		8	
39	000 043 020 00	Optimoly		1	

Model: 911 78

Model life 1978>>1983

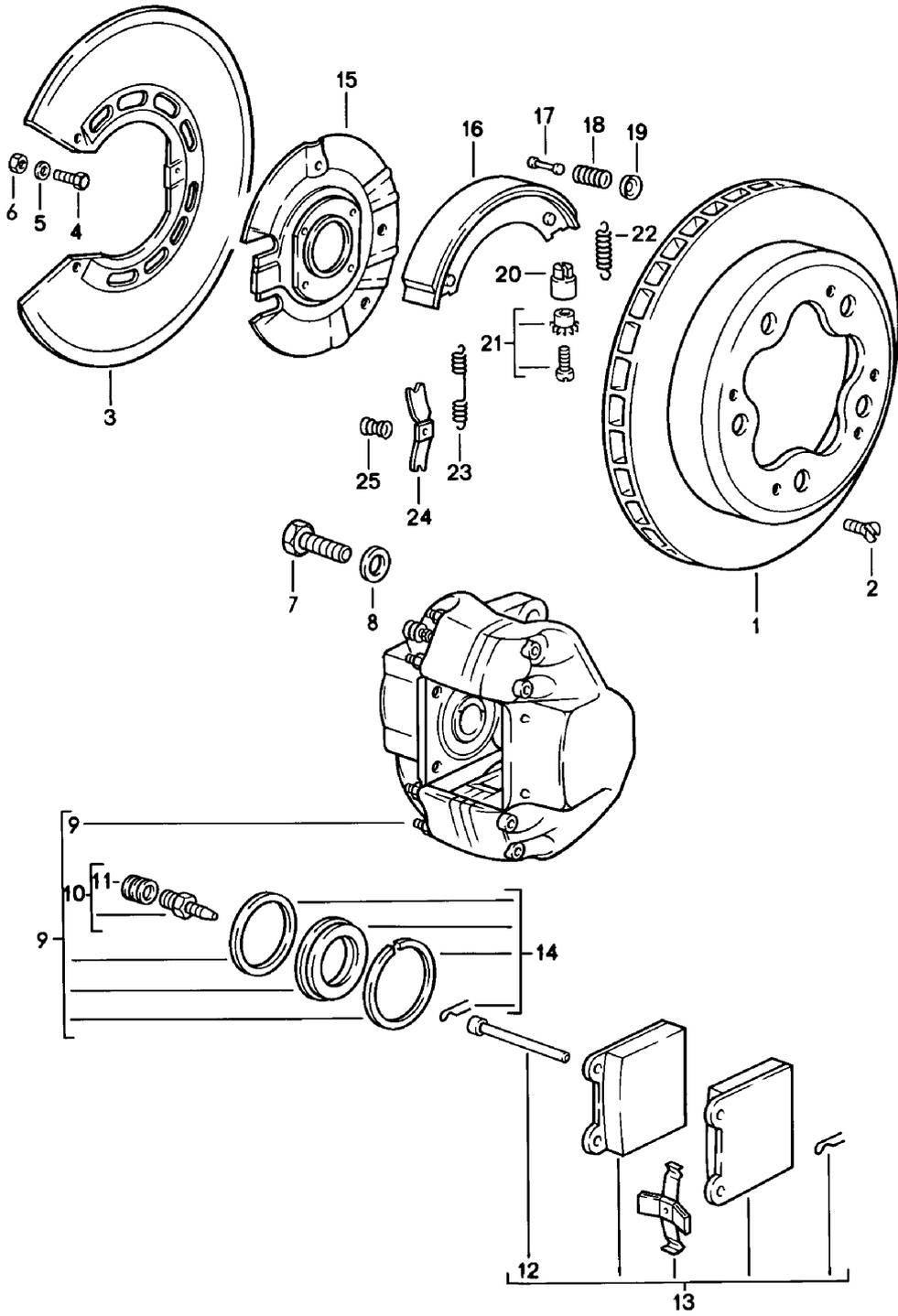

Model: 911 78

Model life 1978>>1983

Pos	Part Number	Description	Remark	Qty	Model
		Disc brake			SC
		Rear axle			
1	901 352 041 14	Brake disc		2	
2	N 033 167 1	Countersunk-head screw		4	
		AM 6 X 12			
2	900 269 047 01	Countersunk-head screw		4	
		AM 6 X 12			
3	911 352 801 20	Protective plate		2	
4	900 075 087 02	Hexagon-head bolt		4	
		M 8 X 16			
4	900 075 087 03	Hexagon-head bolt		4	
		M 8 X 16			
4	900 075 087 02	Hexagon-head bolt		4	
		M 8 X 16			
4	900 075 087 03	Hexagon-head bolt		4	
		M 8 X 16			
(4)	N 010 235 3	Hexagon-head bolt		2	
		M 8 X 10			
5	N 012 241 8	Spring washer		6	
		B 8			
6	900 076 025 02	Hexagon nut		4	
		M 8			
6	900 076 064 02	Hexagon nut		4	
		M 8			
7	N 010 137 2	Hexagon-head bolt		4	
		M 12 X 1,5 X 35			
7	900 083 073 01	Hexagon-head bolt		4	
		M 12 X 1,5 X 35			
8	900 027 017 02	Lock ring		4	
		B 12			
9	911 352 907 00	Fixed calliper	/L	1	
		without pad			
(9)	911 352 908 00	Fixed calliper	/R	1	
		without pad			
10	901 352 977 10	Bleeder valve		2	
11	901 351 927 10	Dust boot		2	
12	901 352 991 01	Retaining pin		4	
(13)	911 352 950 03	Brake pad repair set		1	
		- textar -			
		- textar -			
(13)	911 352 950 05	Brake pad repair set		1	
		- textar -			
(13)	911 352 951 00	Parts kit		1	
		1 set			
14	911 352 998 00	Gasket set		2	
		Handbrake			
-	PCG 352 097 12	Set of fastening parts		1	
		Handbrake			
		Comprising:			
-	900 079 012 02	Castle nut		2	
-	911 352 090 01	Expanding bow		4	
-	901 352 932 10	Return spring		2	
-	911 352 944 00	Support bush		2	
-	901 352 953 12	Compression spring		2	
-	901 352 955 10	Concave washer		4	
-	901 352 957 10	Compression spring		4	
-	901 352 959 11	Roll pin		4	
-	N 012 507 1	Cotter pin		2	
15	911 352 081 30	Brake mounting plate		2	
16	911 352 097 10	Brake shoe		4	
17	901 352 959 10	Roll pin		4	
17	901 352 959 11	Roll pin		4	
18	901 352 957 10	Compression spring		4	

Model: 911 78

Model life 1978>>1983

Pos	Part Number	Description	Remark	Qty	Model
19	901 352 955 10	Concave washer		4	
20	911 352 944 00	Support bush		2	
21	911 352 098 00	Adjusting screw		2	
21	911 352 098 01	Adjusting screw		2	
22	901 352 932 10	Return spring		2	
23	901 352 954 10	Return spring		2	
24	911 352 090 00	Expanding bow		4	
24	911 352 090 01	Expanding bow		4	
25	901 352 953 10	Compression spring		2	
25	901 352 953 11	Compression spring		2	
25	901 352 953 12	Compression spring		2	

Model: 911 78

Model life 1978>>1983

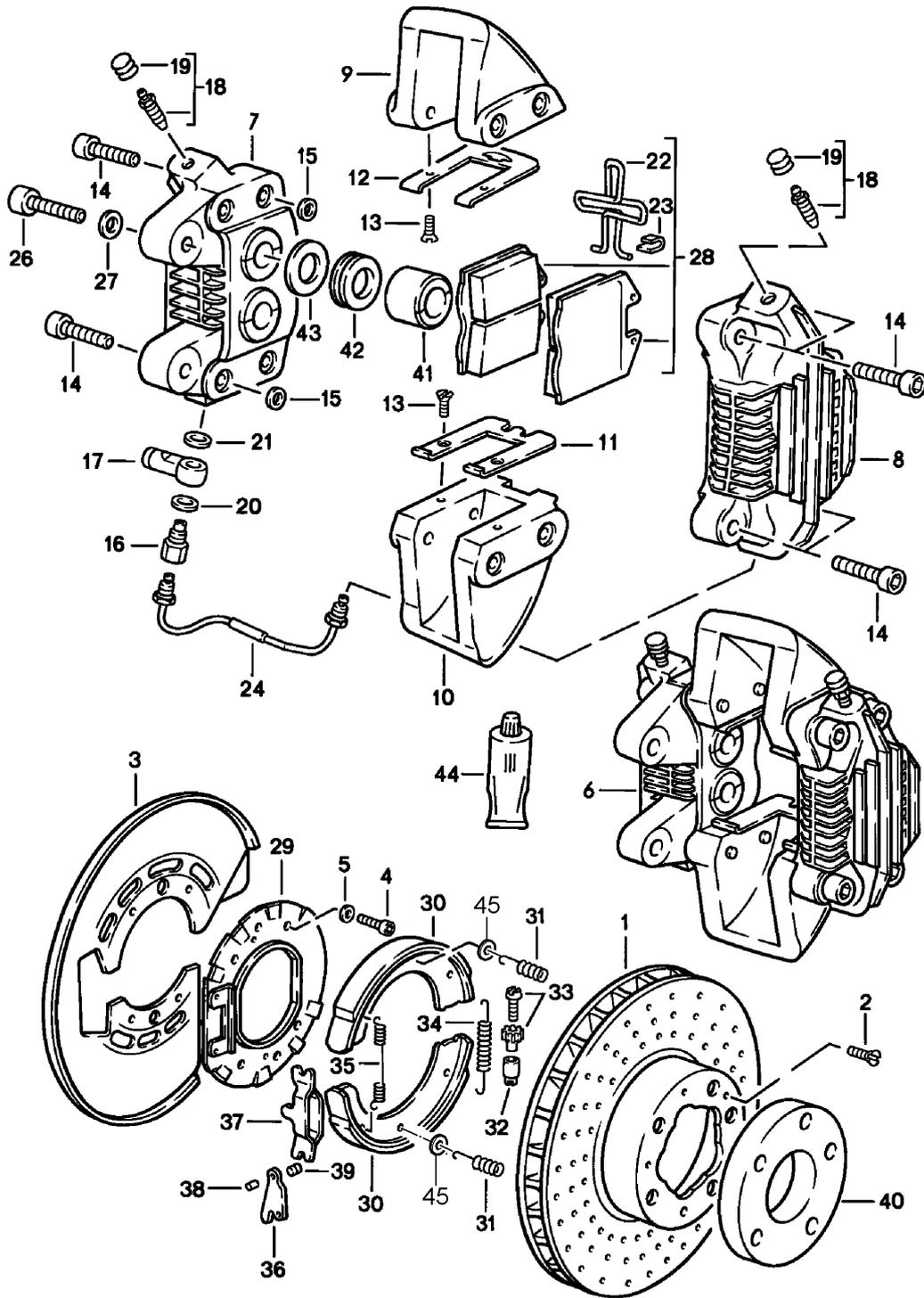

Model: 911 78 Model life 1978>>1983

Pos	Part Number	Description	Remark	Qty	Model
		Disc brake Rear axle			TURBO
1	930 352 045 00	Brake disc	/L	1	
1	930 352 045 01	Brake disc	/L	1	
(1)	930 352 046 00	Brake disc	/R	1	
(1)	930 352 046 01	Brake disc	/R	1	
2	N 033 167 1	Countersunk-head screw M 6 X 12		4	
2	900 269 047 01	Countersunk-head screw M 6 X 12		4	
3	930 352 801 04	Protective plate		2	
4	900 067 057 02	Pan-head screw M 8 X 20		8	
11C	900 067 057 03	Pan-head screw M 8 X 20		8	
5	N 012 241 8	Spring washer B 8		8	
6	930 352 091 03	Brake calliper without pad	/L	1	
(6)	930 352 092 03	Brake calliper without pad	/R	1	
7	930 352 951 00	Brake calliper		2	
7	930 352 951 01	Brake calliper		2	
8	930 352 953 00	Brake calliper		2	
8	930 352 953 01	Brake calliper		2	
9	930 352 563 03	Bridge 1		2	
9		Bridge 1		2	
10	930 352 564 02	Bridge 2		2	
10	930 352 564 04	Bridge 2		2	
11	930 351 539 02	Spring plate 1		2	
12	930 351 540 02	Spring plate 2		2	
13	900 269 017 02	Countersunk-head screw M 5 X 12		8	
14	900 067 170 02	Pan-head screw M 12 X 1,5 X 40		16	
15	930 351 580 01	Spacer sleeve		16	
16	914 355 534 00	Banjo bolt		2	
17	914 355 531 00	Ring fitting		2	
18	930 351 919 00	Ventilation valve		4	
19	901 351 927 10	Dust boot		4	
20	900 123 005 20	Sealing ring A 12 X 16		2	
21	N 013 808 3	Sealing ring A 10 X 16		2	
22	951 352 950 00	Expanding spring		2	
23	930 351 559 00	Tab washer F >>93087 00379 F >>93088 00216 F >>93087 09550	-79	2	
24	930 355 061 01	Connecting line	/L	1	
24	930 355 061 04	Connecting line	/L	1	
(24)	930 355 062 01	Connecting line	/R	1	
(24)	930 355 062 04	Connecting line	/R	1	
26	900 067 170 02	Pan-head screw M 12 X 1,5 X 40		4	
27	900 028 014 02	Washer B 12		4	

Model: 911 78

Model life 1978>>1983

Pos	Part Number	Description	Remark	Qty	Model
27	900 028 014 03	Washer B 12		4	
28	930 351 938 02	Brake pad repair set F >>93087 00379 F >>93088 00216 F >>93087 09550		1	
28	930 351 938 04	Brake pad repair set F 93087 00380>> F 93088 00217>> F 93087 09551>>		1	
(28)	930 351 938 05	Brake pad repair set without asbestos		1	
(28)	951 351 939 04	Brake pad repair set without asbestos		1	
(28)	964 351 939 02	Brake pad repair set without asbestos		1	
(28)	964 351 939 03	Brake pad repair set without asbestos		1	
(28)	951 351 939 03	Brake pad repair set without asbestos Handbrake		1	
29	930 352 081 03	Brake mounting plate		2	
30	928 352 097 00	Brake shoe		4	
30	996 352 993 00	Repair kit without asbestos		4	
30	997 352 993 02	Brake shoe 1 set Only together with Washer 928.352.963.00 Adjusting screw 993.352.071.00		1	
31	930 352 957 00	Compression spring		4	
32	911 352 944 00	Support bush		2	
33	911 352 098 00	Adjusting screw		2	
33	911 352 098 01	Adjusting screw		2	
34	901 352 932 10	Return spring		2	
35	901 352 954 10	Return spring		2	
36	993 352 073 00	Push-button lock		2	
37		Push-button lock		2	
38	993 352 737 00	Bolt		2	
39	928 352 447 00	Articulated bolt		2	
40	930 331 611 04	Spacer ring		2	
40	930 331 611 06	Spacer ring 28 mm		2	
41	930 352 555 01	Piston 30 \$		8	
42	930 352 554 00	Scraper ring		8	
43	930 352 553 02	Sealing ring		8	
44	000 043 020 00	Optimoly - TA -		1	
45	928 352 963 00	Washer Only together with Brake shoe 997.352.993.02		4	

Model: 911 78

Model life 1978>>1983

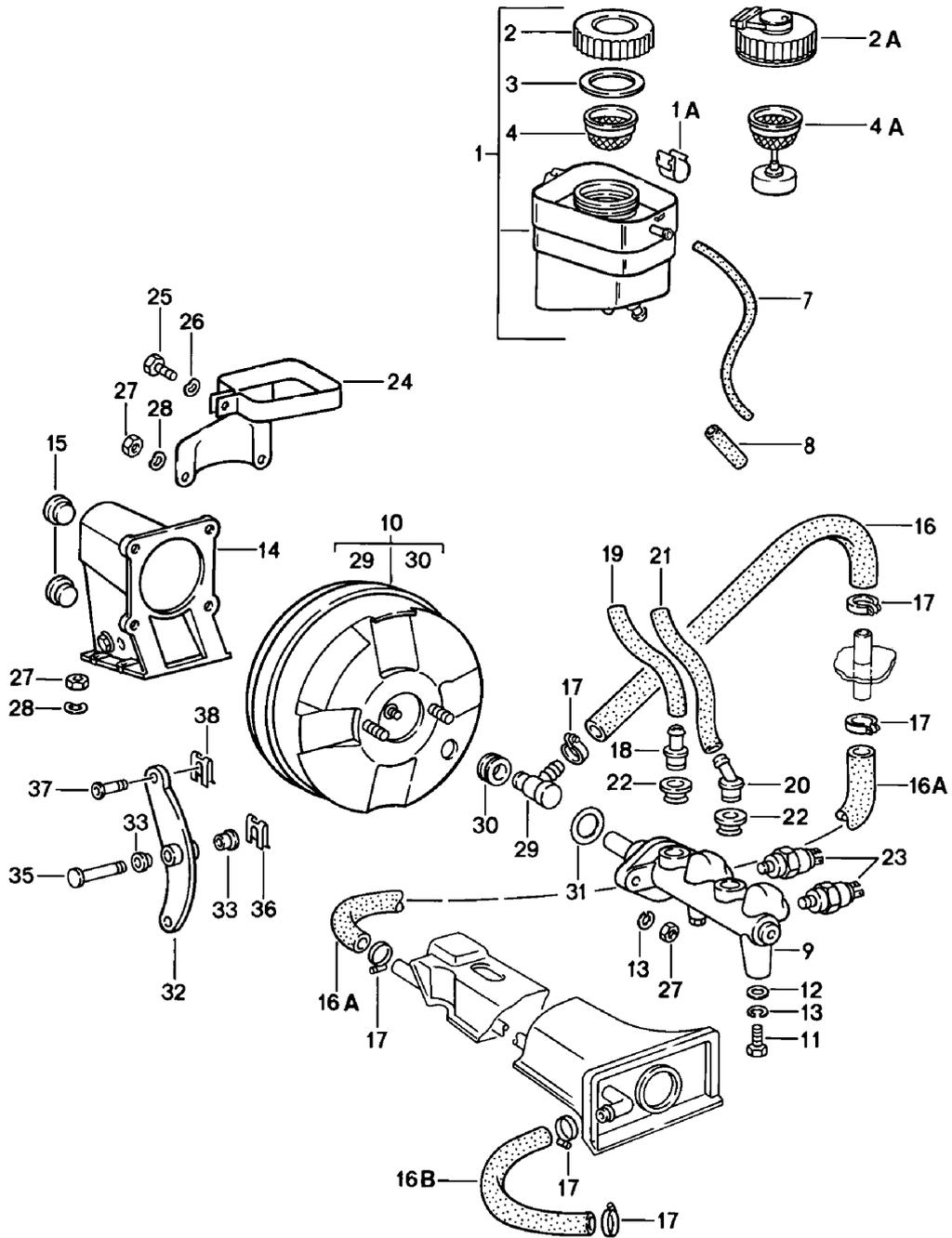

Model: 911 78 Model life 1978>>1983

Pos	Part Number	Description	Remark	Qty	Model
1	911 355 013 13	Brake fluid reservoir Brake master cylinder Brake fluid reservoir Use also:	/RL (AUS) (J) /RL	1	
		911.355.419.02 911.355.420.01			
1A	477 971 939	Cable terminal		1	
1A	PCG 971 939	Cable terminal		1	
2	911 355 905 02	Lid		1	
2A	911 355 419 02	Threaded joint with Warning contact		1	M592
3	901 355 908 00	Gasket		1	
4	211 611 381 B	Strainer		1	
4		Strainer		1	
4A	911 355 420 01	Float		1	M592
-	N 020 361 2	Hose 4 X 1,5 900 MM	/LL	*	
7		1500 MM	/RL	1	
(7)				1	
8	911 355 155 00	Pipe 5 X 3 X 1280		1	
9	911 355 011 11	Brake master cylinder		1	SC
9	911 355 011 12	Brake master cylinder		1	SC
(9)	930 355 011 03	Brake master cylinder		1	TURBO
10	930 355 027 00	Vacuum booster		1	SC
11	N 010 237 6	Hexagon-head bolt M 8 X 12		1	
11	N 010 237 14	Hexagon-head bolt M 8 X 12		1	
12	900 151 008 02	Washer A 8,4		1	
13	900 027 015 02	Lock ring B 8		3	
13	900 027 015 03	Lock ring B 8		3	
14	911 355 381 01	Bearing bracket	/LL	1	
(14)	911 355 382 00	Bearing bracket	/RL	1	
15	999 703 056 40	Stopper		2	
16	911 355 609 00	Moulded hose	/LL	1	
-	999 181 022 51	Hose 11,8 X 4 320 MM	/LL	*	
16A		Tunnel Boot floor plate		1	
-		790 MM	/RL	1	
		Tunnel Brake booster			
16B		1430 MM Engine		1	SC
		Tunnel 1700 MM Engine			
16B		Tunnel		1	TURBO
17	900 272 003 02	Hose clamp		6	
17	999 512 554 00	Hose clamp		6	
18	911 355 322 00	Intake socket		1	
-	999 181 021 50	Hose 7,5 X 12,5		*	
19		65 MM		1	
20	911 355 323 00	Intake socket		1	

Model: 911 78 Model life 1978>>1983

Pos	Part Number	Description	Remark	Qty	Model
-	999 181 021 50	Hose 7,5 X 12,5		*	
21		120 MM		1	
22	911 355 922 00	Sealing plug		2	
23	113 945 515 G	Brake light switch		2	
24	911 355 038 01	Retaining strap		1	
25	900 075 057 02	Hexagon-head bolt M 6 X 16		1	
25	900 075 057 03	Hexagon-head bolt M 6 X 16		1	
26	N 011 524 7	Washer		1	
26	N 011 524 27	Washer		1	
27	900 076 025 02	Hexagon nut M 8		10	
27	900 076 064 02	Hexagon nut M 8		10	
28	N 012 241 8	Spring washer B 8		8	
29	191 611 933 F	Check valve		1	
29		Check valve		1	
30	911 355 921 00	Rubber seal		1	
30	955 355 921 00	Rubber seal		1	
31	251 611 243	Sealing ring		1	
32	911 355 084 00	Reverse lever	/RL	1	
(32)	911 355 083 03	Reverse lever	/LL	1	
33	928 423 542 00	Bearing sleeve		2	
35	911 355 511 01	Bearing pin		1	
36	N 012 654 1	Lock washer		1	
37	999 166 049 02	Bolt		1	
37	N 012 654 1	Lock washer		1	
38	999 166 034 02	Sl-lock		1	

Model: 911 78

Model life 1978>>1983

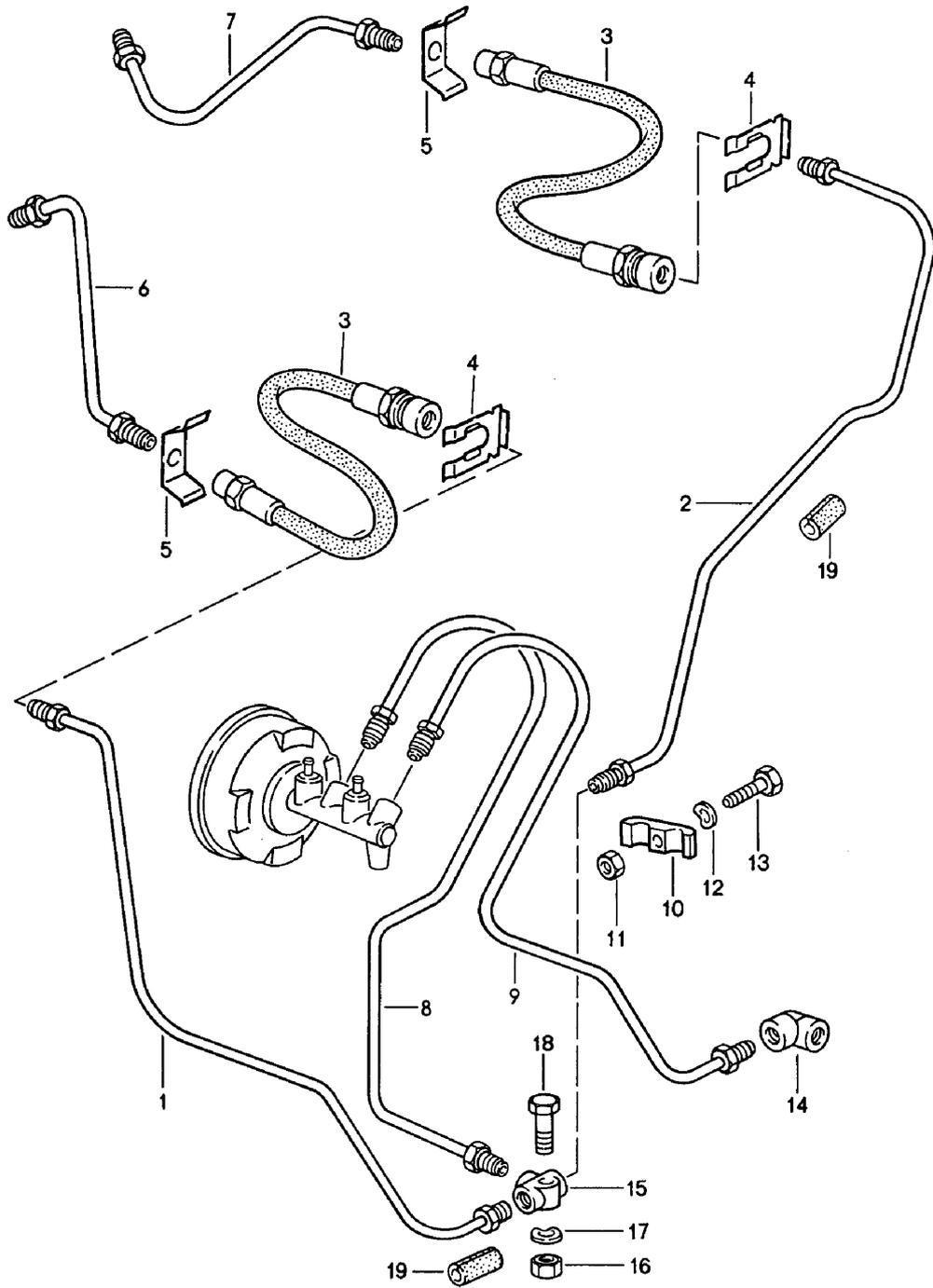

Model: 911 78

Model life 1978>>1983

Pos	Part Number	Description	Remark	Qty	Model
		Brake lines Front			
1	911 355 618 01	Brake line	/L	1	
2	911 355 617 02	Brake line	/R	1	
3	901 355 632 01	Brake hose		2	
3	901 355 632 02	Brake hose		2	
4	113 611 715 A	Brake hose bracket		2	
5	803 611 715	Retainer spring		2	
6	911 355 605 01	Brake line		2	SC
6	930 355 063 00	Brake line	/L	1	TURBO
7	930 355 064 00	Brake line	/R	1	TURBO
8	911 355 608 03	Connecting line	/LL	1	
8	911 355 065 00	Connecting line	/RL	1	
9	911 355 607 03	Connecting line	/LL	1	
9	911 355 066 00	Connecting line	/RL	1	
10	999 511 112 40	Dual clip		1	
11	999 084 018 02	Lock nut M 6		1	
12	N 012 226 5	Spring washer A 6		1	
13	900 075 016 02	Hexagon-head bolt M 6 X 22		1	
13	900 075 016 03	Hexagon-head bolt M 6 X 22		1	
14	901 355 615 00	Angled pipe		1	
14	901 355 615 01	Angled pipe		1	
15	914 355 667 00	Distributor		1	
16	900 076 010 02	Nut M 6		1	
16	900 076 010 0B	Nut M 6		1	
17	N 011 524 7	Washer		1	
17	N 011 524 27	Washer		1	
18	900 075 017 02	Hexagon-head bolt M 6 X 25		1	
18	900 075 017 03	Hexagon-head bolt M 6 X 25		1	
18	900 075 341 02	Combination screw M 6 X 25		1	
18	900 075 341 01	Combination screw M 6 X 25		1	
19	914 355 691 00	Protective tube		3	

Model: 911 78

Model life 1978>>1983

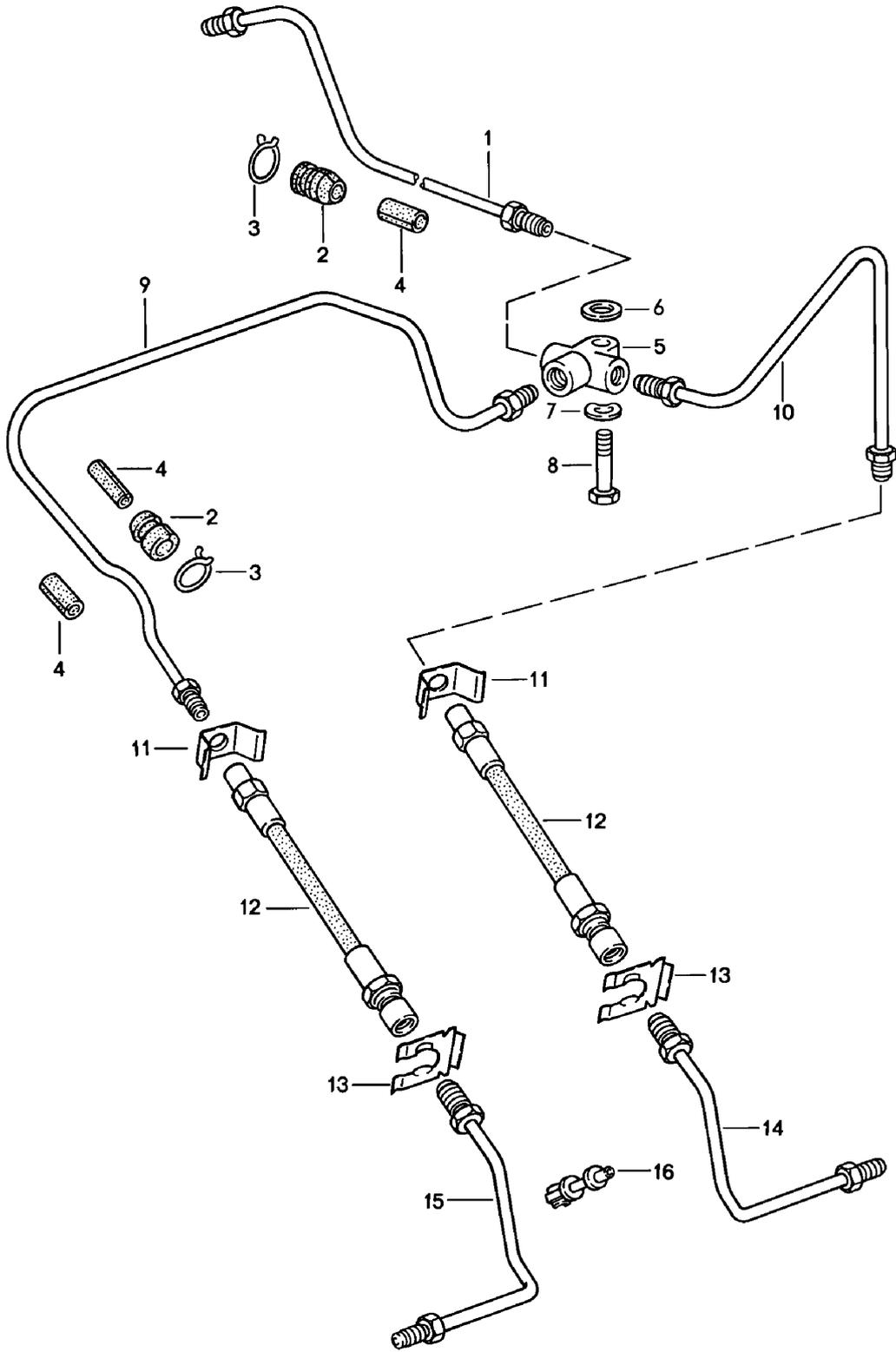

Model: 911 78

Model life 1978>>1983

Pos	Part Number	Description	Remark	Qty	Model
		Brake lines Rear			
1	911 355 611 01	Brake line		1	
2	914 355 651 00	Rubber sleeve		2	
3	914 355 652 00	Clamp		2	
4	914 355 691 00	Protective tube		3	
5	914 355 667 00	Distributor		1	
6	900 151 006 09	Washer B 6,4		1	
6	N 011 666 7	Washer B 6,4		1	
7	N 011 524 7	Washer		1	
7	N 011 524 27	Washer		1	
8	900 075 341 02	Combination screw M 6 X 25		1	
8	900 075 341 01	Combination screw M 6 X 25		1	
9	911 355 627 04	Connecting line	/L	1	SC
9	930 355 627 04	Connecting line	/L	1	TURBO
9		Connecting line	/L	1	TURBO
10	911 355 653 05	Connecting line	/R	1	SC
10	930 355 653 02	Connecting line	/R	1	TURBO
10	930 355 653 05	Connecting line	/R	1	TURBO
11	803 611 715	Retainer spring		2	
12	901 355 631 01	Brake hose		2	
12	901 355 631 02	Brake hose		2	
13	113 611 715 A	Brake hose bracket		2	
(14)	911 355 621 02	Brake line		2	SC
14	930 355 066 00	Brake line	/R	1	TURBO
15	930 355 065 00	Brake line	/L	1	TURBO
16	999 507 235 40	Pipe clip		2	TURBO

Model: 911 78

Model life 1978>>1983

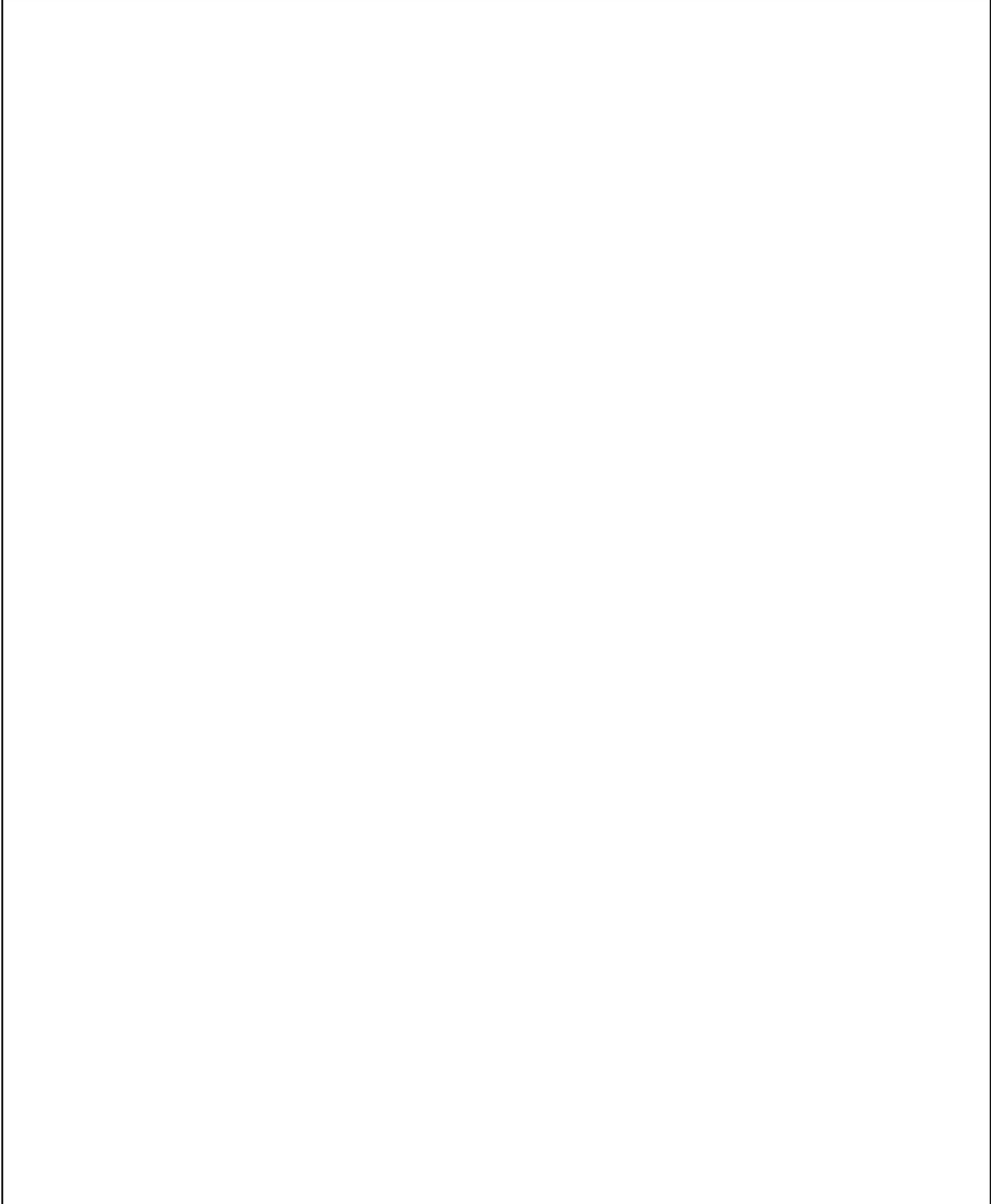

Model: 911 78

Model life 1978>>1983

Pos	Part Number	Description	Remark	Qty	Model
>>	911 351 950 06	Repair kits Front axle Brake pad repair set Comprising:		1	SC
		Brake pad		4	
>>	911 351 950 08	Brake pad repair set Comprising:		1	SC
		Brake pad		4	
>>	911 351 951 00	Parts kit Comprising:		1	SC
		Expanding spring		2	
		Retaining pin		4	
>>	911 351 946 00	Gasket set for Fixed calliper 911.351.425/426.01 Comprising:		2	SC
		Gasket		2	
		Protection cap		2	
		Clamping ring		2	
>>	911 352 950 03	Rear axle Brake pad repair set Comprising:		1	SC
		Brake pad		4	
>>	911 352 950 05	Brake pad repair set Comprising:		1	
		Brake pad		4	
>>	911 352 951 00	Parts kit Comprising:		1	SC
		Expanding spring		2	
		Retaining pin		4	
>>	911 352 998 00	Safety seal Gasket set for Fixed calliper 1 set Comprising:		4	SC
		Gasket		2	
		for Piston			
		Protection cap		2	
		Clamping ring		2	
		Safety seal		1	
		Safety seal		1	
>>	930 351 938 05	Front axle Rear axle Brake pad repair set Comprising:		2	TURBO
		Brake pad		4	
>>	951 351 939 04	Brake pad repair set Comprising:		2	TURBO
		Brake pad		4	
>>	964 351 939 02	Brake pad repair set Comprising:		2	TURBO
		Brake pad		4	
>>	964 351 939 03	Brake pad repair set Comprising:		2	TURBO
		Brake pad		4	
>>	951 351 939 03	Brake pad repair set without asbestos Comprising:		2	TURBO
		Brake pad		4	
>>	911 355 925 00	Repair kit		1	SC

Model: 911 78

Model life 1978>>1983

Pos	Part Number	Description	Remark	Qty	Model
		Brake master cylinder 911.355.011.10 20,64 MM Comprising: Support ring		1	
		Boot		1	
		Washer		1	
		Piston		1	
		Boot		2	
		Sealing ring		1	
		Support ring		1	
		Boot		1	
		Washer		1	
		Piston		1	
		Washer		2	
		Boot		2	
		Intermediate ring		1	
		Circlip	25 X 1,2	1	
		O-ring		1	
>>	928 355 913 00	Repair kit		1	TURBO
		Brake master cylinder 930.355.011.01 23,81 MM Comprising: Support ring		1	
		Boot		1	
		Washer		1	
		Piston		1	
		Boot		2	
		Sealing ring		1	
		Support ring		1	
		Boot		1	
		Washer		1	
		Piston		1	
		Washer		2	
		Boot		2	
		Intermediate ring		1	
		Circlip		1	
		O-ring		1	

Model: 911 78

Model life 1978>>1983

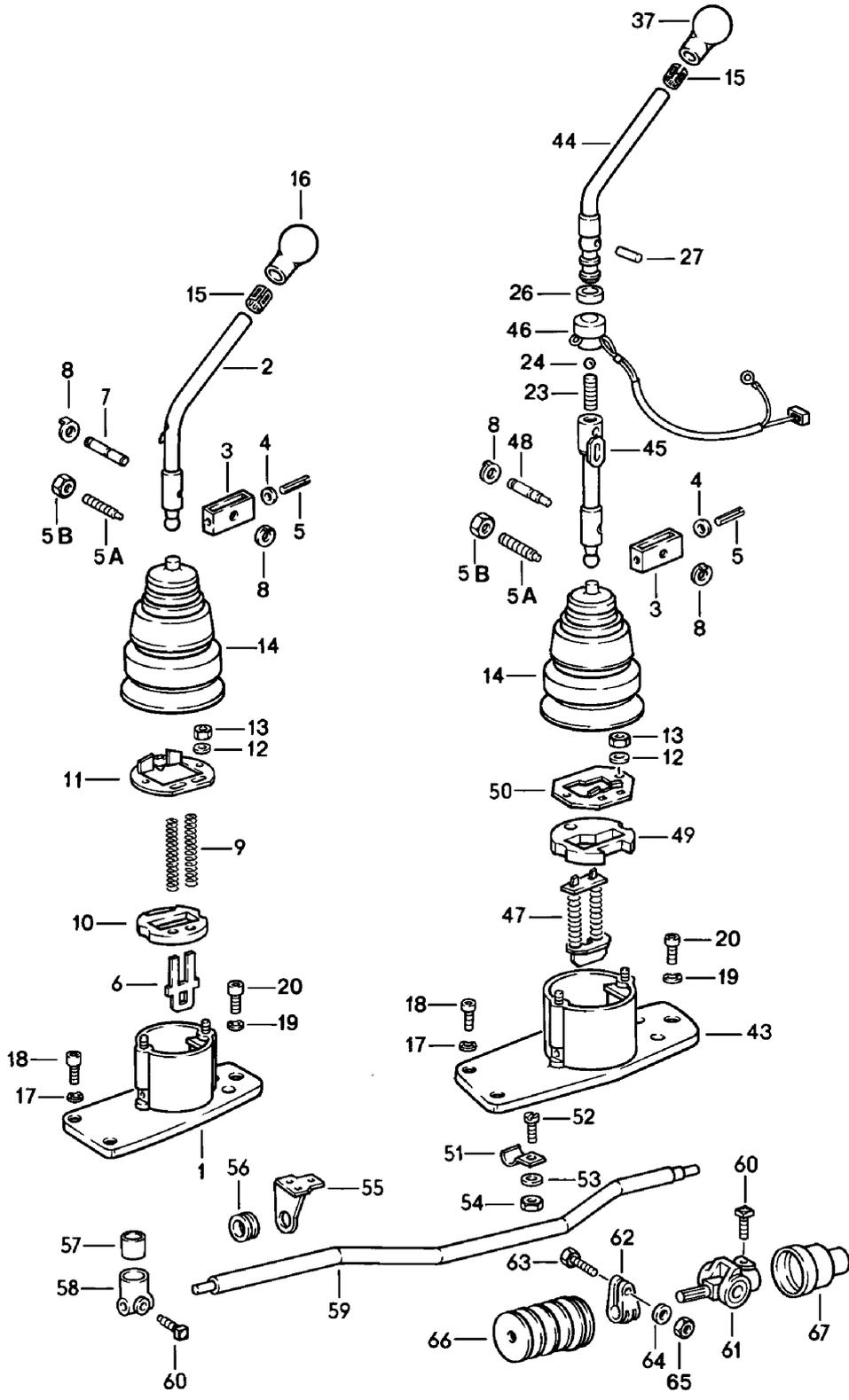

Model: 911 78

Model life 1978>>1983

Pos	Part Number	Description	Remark	Qty	Model
		Transmission control			
1	911 424 019 06	Gearshift bracket		1	
2	911 424 017 07	Gearshift lever		1	SC
(2)	930 424 017 00	Gearshift lever		1	TURBO
3	911 424 124 02	Shift-lever bearing		1	SC
(3)	930 424 071 00	Fork		1	TURBO
-	930 424 125 00	Leaf spring		1	TURBO
-	900 234 041 01	Shim 10 X 16 X 1,3		1	TURBO
-	900 116 007 01	Lock washer 8		1	TURBO
-	N 012 439 1	Lock washer 8		1	TURBO
-	N 012 439 2	Lock washer 8		1	TURBO
4	900 025 007 02	Washer A 8,4		1	SC
4	900 025 007 03	Washer A 8,4		1	SC
4	911 424 187 01	Shim 0,2 MM		1	TURBO
5	900 197 035 01	Tensioning sleeve 8 X 28		1	
5	900 197 035 0B	Tensioning sleeve 8 X 28		1	
5A	911 424 335 00	Threaded pin		1	
5B	N 011 113 3	Hexagon nut M 14		1	
6	911 424 144 00	Guide plate		1	SC
7	911 424 129 06	Bearing pin		1	SC
8	999 166 027 02	Circlip		2	SC
9	911 424 131 01	Compression spring		2	SC
10	911 424 147 00	Buffer plate		1	SC
(10)	930 424 147 00	Buffer plate		1	TURBO
-	930 424 165 01	Retainer plate		1	TURBO
11	911 424 063 04	Pawl carrier plate 5-speed		1	SC
12	N 012 006 4	Lock ring B 6		2	
13	900 076 010 02	Nut M 6		2	
13	900 076 010 0B	Nut M 6		2	
14	911 424 181 01	Sleeve		1	
15	999 532 003 00	Retainer		1	
16	930 424 069 01	Gearshift knob 4-speed		1	TURBO
(16)	911 424 071 01	Gearshift knob 5-speed		1	SC
17	N 012 241 1	Spring washer B 8		3	
18	900 067 057 02	Pan-head screw M 8 X 20		3	
18	900 067 057 03	Pan-head screw M 8 X 20		3	
19	900 028 008 01	Lock ring B 6		2	
20	900 067 011 02	Pan-head screw M 6 X 20		2	
20	900 067 011 03	Pan-head screw M 6 X 20		2	
23	905 424 111 02	Compression spring		1	SC/SPM
24	900 108 012 00	Ball		1	SC/SPM

Model: 911 78 Model life 1978>>1983

Pos	Part Number	Description	Remark	Qty	Model
26	925 424 234 00	Stop ring		1	SC/SPM
27	905 424 107 02	Straight pin		1	SC/SPM
-	999 513 021 40	Tie-wrap		2	SC/SPM
37	911 424 073 01	Gearshift knob 3 speed		1	SC/SPM
43	925 424 019 01	Gearshift bracket		2	SC/SPM
44	925 424 023 02	Gearshift lever		3	SC/SPM
45	925 424 024 02	Gearshift lever		3	SC/SPM
46	905 613 039 00	Contacts		1	SC/SPM
46	905 613 039 01	Contacts		1	SC/SPM
47	930 424 029 00	Guide plate		1	SC/SPM
48	925 424 129 01	Bearing pin		1	SC/SPM
49	925 424 147 00	Buffer plate		1	SC/SPM
50	925 424 165 00	Stop plate		1	SC/SPM
51	900 171 008 02	Cable clip		1	SC/SPM
52	900 015 003 10	Pan-head screw M 4 X 10		1	SC/SPM
53	900 114 014 01	Shake-proof washer		1	SC/SPM
54	900 076 002 10	Hexagon nut M 4		1	SC/SPM
55	930 424 031 00	Bearing bracket	-82	1	SC
55	930 424 031 01	Bearing bracket		1	SC
55	930 424 031 00	Bearing bracket	83-	1	SC
55	930 424 031 01	Bearing bracket	83-	1	SC
55	930 424 031 00	Bearing bracket		1	TURBO
55	930 424 031 01	Bearing bracket		1	TURBO
56	914 424 224 00	Friction ring		1	
57	911 424 139 00	Ball socket		1	
57	911 424 139 01	Ball socket		1	
(58)	930 424 241 00	Head shift rod		1	
59	911 424 020 00	Gear shift rod		1	
-	PCG 424 020 00	Repair kit Gear shift rod Comprising:		1	
-	911 424 024 04	Shift rod coupling		1	
-	911 424 139 01	Ball socket		1	
-	914 424 224 00	Friction ring		1	
-	901 424 229 00	Conical screw		2	
60		Conical screw		2	
61	911 424 024 04	Shift rod coupling		1	
-	964 424 223 00	Bush		2	
62	914 424 214 00	Clamp		1	
63	N 010 335 5	Hexagon-head bolt M 8 X 35		1	
63	900 075 032 03	Hexagon-head bolt M 8 X 35		1	
64	999 523 102 02	Washer		1	
64	999 523 102 0B	Washer		1	
65	900 076 025 02	Hexagon nut M 8		1	
65	900 076 064 02	Hexagon nut M 8		1	
66	911 424 292 00	Sealing sleeve		1	
67	911 424 294 00	Sealing sleeve		1	

Model: 911 78

Model life 1978>>1983

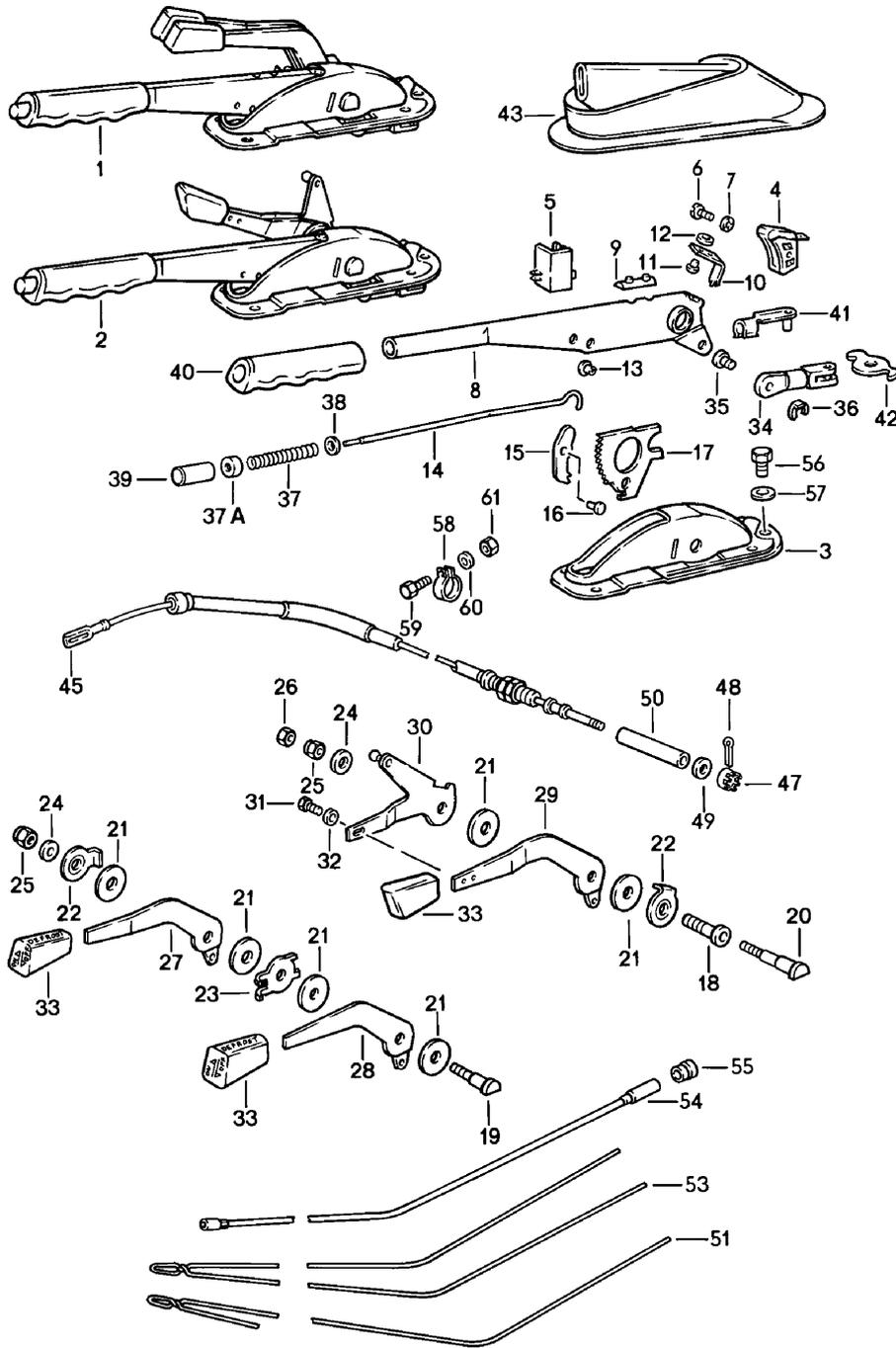

Model: 911 78

Model life 1978>>1983

Pos	Part Number	Description	Remark	Qty	Model
1	911 424 051 08	Parking-brake lever Actuating lever for Heating	-81	1	SC
1	911 424 051 13	Parking-brake lever with bearing bracket	82-	1	SC
2	911 424 051 14	Parking-brake lever with bearing bracket Heating	-81	1	
2		Automatic Parking-brake lever with bearing bracket Heating		1	
3	901 424 058 02	Bearing bracket		1	
4	901 613 521 20	Contact switch		1	
5	911 613 525 00	Heating lever contact		1	SC
6	900 015 025 02	Oval-head screw AM 4 X 15		1	
7	900 115 005 02	Washer A 4,3		1	
8	911 424 059 00	Parking-brake lever		1	
9	901 424 509 01	Stop		1	
10	901 613 523 20	Contact bow		1	
11	900 055 001 20	Buttonhead rivet		2	
12	900 031 012 10	Washer 2,8		2	
13	900 206 003 00	Tubular rivet 5 X 0,5 X 10		1	
14	901 424 567 03	Push rod		1	
15	901 424 508 00	Pawl		1	
16	901 424 511 00	Bolt		1	
17	914 424 541 00	Locking segment		1	
18	911 424 717 00	Tensioning sleeve	-81	1	
18	911 424 717 01	Tensioning sleeve	82-	1	
19	911 424 515 00	Collar bolt		1	SC
20	911 424 519 02	Collar bolt		1	
21	911 424 737 00	Washer		4	
22	911 424 735 04	Disc		1	
22		Disc		1	
23	911 424 735 03	Disc		1	SC
23	911 424 735 06	Disc		1	SC
24	999 523 006 00	Cup spring		2	
25	999 084 019 02	Lock nut		1	
26	999 084 043 02	Hexagon nut M 5		1	
27	911 424 711 02	Actuating lever		1	SC
28	911 424 711 03	Actuating lever		1	SC
29	911 424 711 04	Lever for Control mechanism	-81	1	
30	911 424 075 00	Connecting lever Heating	-81	1	
30	911 424 075 02	Automatic Connecting lever Heating	82-	1	
31	900 075 276 02	Automatic Pan-head screw M 5 X 6		1	TURBO
31		Pan-head screw M 5 X 6		1	TURBO

Model: 911 78

Model life 1978>>1983

Pos	Part Number	Description	Remark	Qty	Model
32	N 012 225 2	Spring washer B 5		1	TURBO
33	911 424 792 03	Control button		2	
34	901 424 569 01	Fork		1	
35	999 166 010 02	Bolt A 6 X 16 X 3		1	
36	999 166 008 02	Safety clip		1	
37	901 424 543 00	Compression spring		1	
37A	914 424 258 00	Guide sleeve		1	
38	901 424 593 01	Ring		1	
39	901 424 523 01	Push button		1	
40	901 424 521 01	Handle		1	
41	999 166 001 02	Bolt 6 X 24		1	
42	901 424 568 00	Turnbuckle		1	
43	911 424 591 03	Sleeve for Parking-brake lever		1	SC
45	911 424 551 02	Parking-brake cable		2	SC
45	911 424 551 03	Parking-brake cable		2	SC
45	911 424 551 04	Parking-brake cable		2	SC
45	930 424 051 02	Parking-brake cable		2	TURBO
45	930 424 051 03	Parking-brake cable		2	TURBO
47	900 079 012 02	Castle nut M 6 1,5 X 15		2	
48	N 012 507 1	Cotter pin 1,5 X 15		2	
49	900 151 006 09	Washer B 6,4		4	
49	N 011 666 7	Washer B 6,4		4	
50	901 424 557 01	Spacer tube		2	SC
51	911 424 701 01	Wire pull		2	SC
53	911 424 701 02	Wire pull Heating Automatic		1	M424
54	901 424 704 01	Guide		2	
55	914 504 319 00	Grommet		2	
56	900 075 087 02	Hexagon-head bolt M 8 X 16		3	
56	900 075 087 03	Hexagon-head bolt M 8 X 16		3	
56	900 075 087 02	Hexagon-head bolt M 8 X 16		3	
56	900 075 087 03	Hexagon-head bolt M 8 X 16		3	
57	900 027 015 02	Lock ring B 8		3	
57	900 027 015 03	Lock ring B 8		3	
57	900 027 015 02	Lock ring B 8		3	
57	900 027 015 03	Lock ring B 8		3	
58	999 706 009 80	Suspension strap	-82	1	
58	911 424 341 01	Suspension strap	-82	1	
58	911 424 341 03	Suspension strap		1	
59	900 075 057 02	Hexagon-head bolt M 6 X 16	-82	1	
59	900 075 057 03	Hexagon-head bolt M 6 X 16		1	
60	N 011 524 7	Washer	-82	1	

Model: 911 78

Model life 1978>>1983

Pos	Part Number	Description	Remark	Qty	Model
60	N 011 524 27	Washer		1	
61	900 076 010 02	Nut M 6	-82	1	
61	900 076 010 0B	Nut M 6	-82	1	

Model: 911 78

Model life 1978>>1983

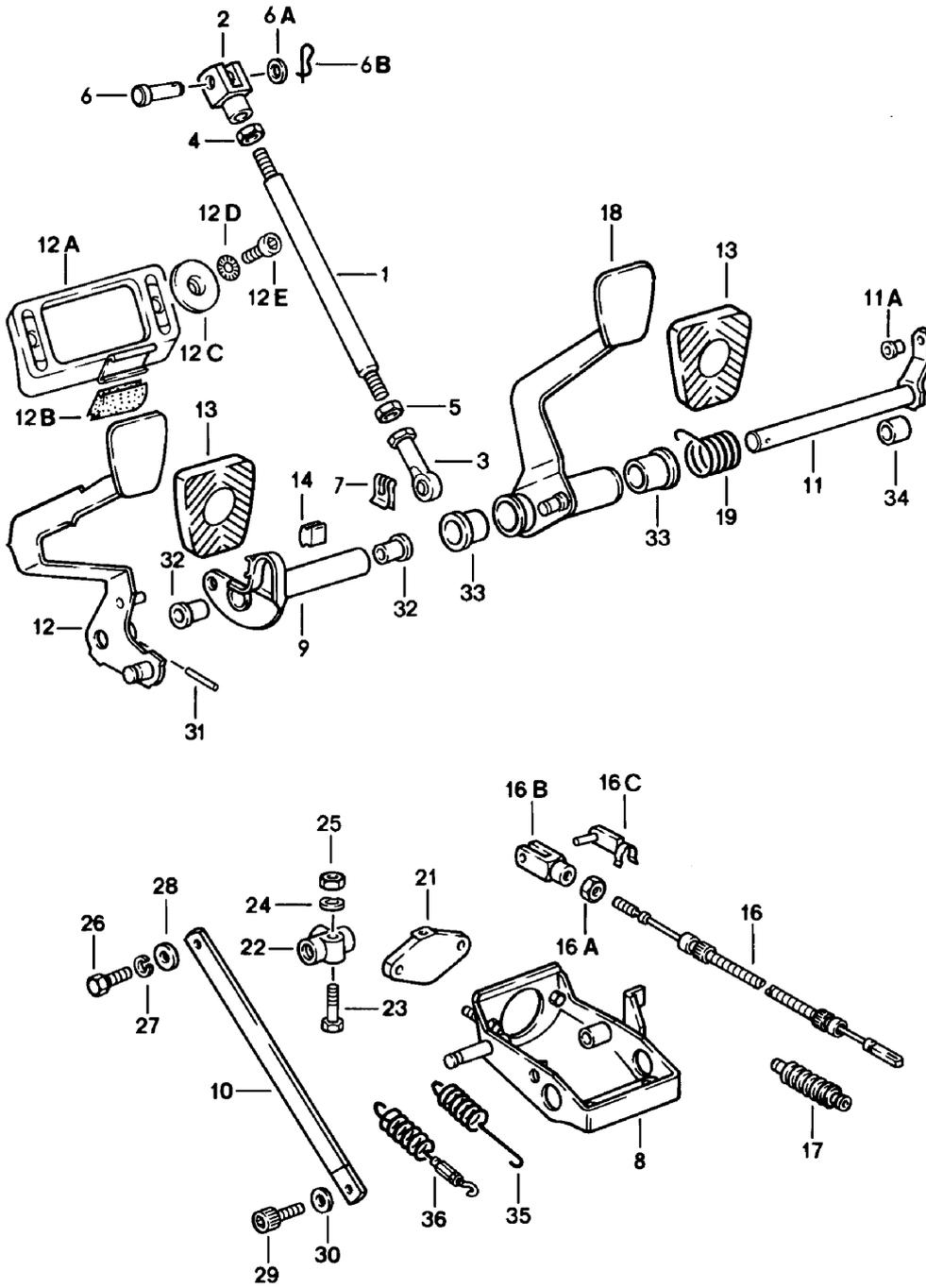

Model: 911 78 Model life 1978>>1983

Pos	Part Number	Description	Remark	Qty	Model
1	911 423 523 01	Pedals	/LL	1	
-	PCG 911 423 00	Push rod		1	
		Kit		1	
		Bush			
		Pedals			
		Comprising:			
-	900 021 008 00	Cotter pin		1	
-	900 021 008 0A	Cotter pin		1	
-	999 166 001 02	Bolt		1	
-	900 309 002 00	Roll pin		1	
-	901 423 193 00	Rubber stop		1	
-	914 423 210 00	Rubber pad		2	
-	901 423 253 00	Bearing sleeve		2	
-	911 423 341 01	Bush		2	
-	901 423 343 00	Bush		2	
-	901 423 391 00	Rubber stop		1	
-	911 423 542 00	Bush		2	
2	999 166 039 02	Clevis		1	
3	999 593 116 02	Swivel head		1	
4	900 157 002 02	Hexagon nut		1	
		M 10			
4	900 157 002 03	Hexagon nut		1	
		M 10			
5	900 157 003 02	Hexagon nut		1	
		M 10			
6	900 087 037 02	Bolt		1	
		10 H 11 X 28 X 23,5			
6A	900 031 005 02	Washer		1	
		10,5			
6A	900 031 005 03	Washer		1	
		10,5			
6B	999 021 001 07	Connector		1	
7	999 166 034 02	Sl-lock		1	
8	911 423 065 04	Bearing bracket		1	
9	911 423 062 00	Bearing tube		1	
(9)	925 423 035 00	Bearing tube		1	SC/SPM
10	911 423 082 00	Tension strut		1	
11	930 423 027 01	Clutch pedal shaft		1	SC
(11)	930 423 027 04	Clutch pedal shaft		1	TURBO
11A	901 423 343 00	Bush		1	
12	911 423 077 05	Clutch pedal	-81	1	
12		Clutch pedal		1	
12A	901 423 036 00	Stop		1	
12B	901 423 391 00	Rubber stop		1	
12C	901 423 368 00	Desk pad		2	
12D	N 012 130 2	Shake-proof washer		2	TURBO
12E	900 119 025 02	Pan-head screw		2	
		M 5X15			
13	914 423 210 00	Rubber pad		2	
13	905 423 511 00	Rubber pad		1	SC/SPM
14	911 423 391 02	Protective strip		1	
16	930 423 401 06	Clutch cable		1	TURBO
		F >>93087 00316			
		F >>93087 09547			
16	930 423 401 10	Clutch cable		1	TURBO
		F >>93087 00316			
		F >>93087 09547			
16	930 423 401 05	Clutch cable		1	
		F 93087 00317>>			
		F 93087 09548>>			
16	930 423 401 09	Clutch cable		1	
		F 93087 00317>>			
		F 93087 09548>>			

Model: 911 78

Model life 1978>>1983

Pos	Part Number	Description	Remark	Qty	Model
16	930 423 401 05	Clutch cable		1	SC
16	930 423 401 09	Clutch cable		1	SC
16A	900 076 010 02	Nut M 6		2	
16A	900 076 010 0B	Nut M 6		2	
16B	900 166 002 02	Clevis G 6 X 24		1	
16B	900 166 002 01	Clevis G 6 X 24		1	
16C	999 166 001 02	Bolt 6 X 24		1	
-	999 512 291 02	Hose clamp		1	
17	311 713 269 A	Bellows		1	
18	911 423 053 05	Brake pedal		1	
18	925 423 053 01	Brake pedal		1	SC/SPM
19	911 423 531 03	Return spring		1	
21	911 423 153 00	Cover plate	-79	1	
22	914 355 667 00	Distributor		1	
23	900 075 341 02	Combination screw M 6 X 25		1	
23	900 075 341 01	Combination screw M 6 X 25		1	
24	N 011 524 7	Washer		1	
24	N 011 524 27	Washer		1	
25	900 076 010 02	Nut M 6		1	
25	900 076 010 0B	Nut M 6		1	
26	N 010 253 7	Hexagon-head bolt M 10 X 22		1	
27	900 027 016 02	Lock ring B 10		1	
27	900 027 016 03	Lock ring B 10		1	
28	900 025 008 09	Washer 10,5		1	
28	900 025 008 04	Washer 10,5		1	
29	900 067 063 02	Pan-head screw M 10 X 20		1	
30	999 523 103 02	Lock washer 10		1	
31	900 309 002 00	Roll pin 6 X 28		1	
32	911 423 341 01	Bush		2	
33	911 423 542 00	Bush		2	
34	911 423 219 03	Spacer sleeve		1	
35	911 423 305 06	Return spring		1	SC
36	930 423 005 00	Clutch spring		1	TURBO

Model: 911 78

Model life 1978>>1983

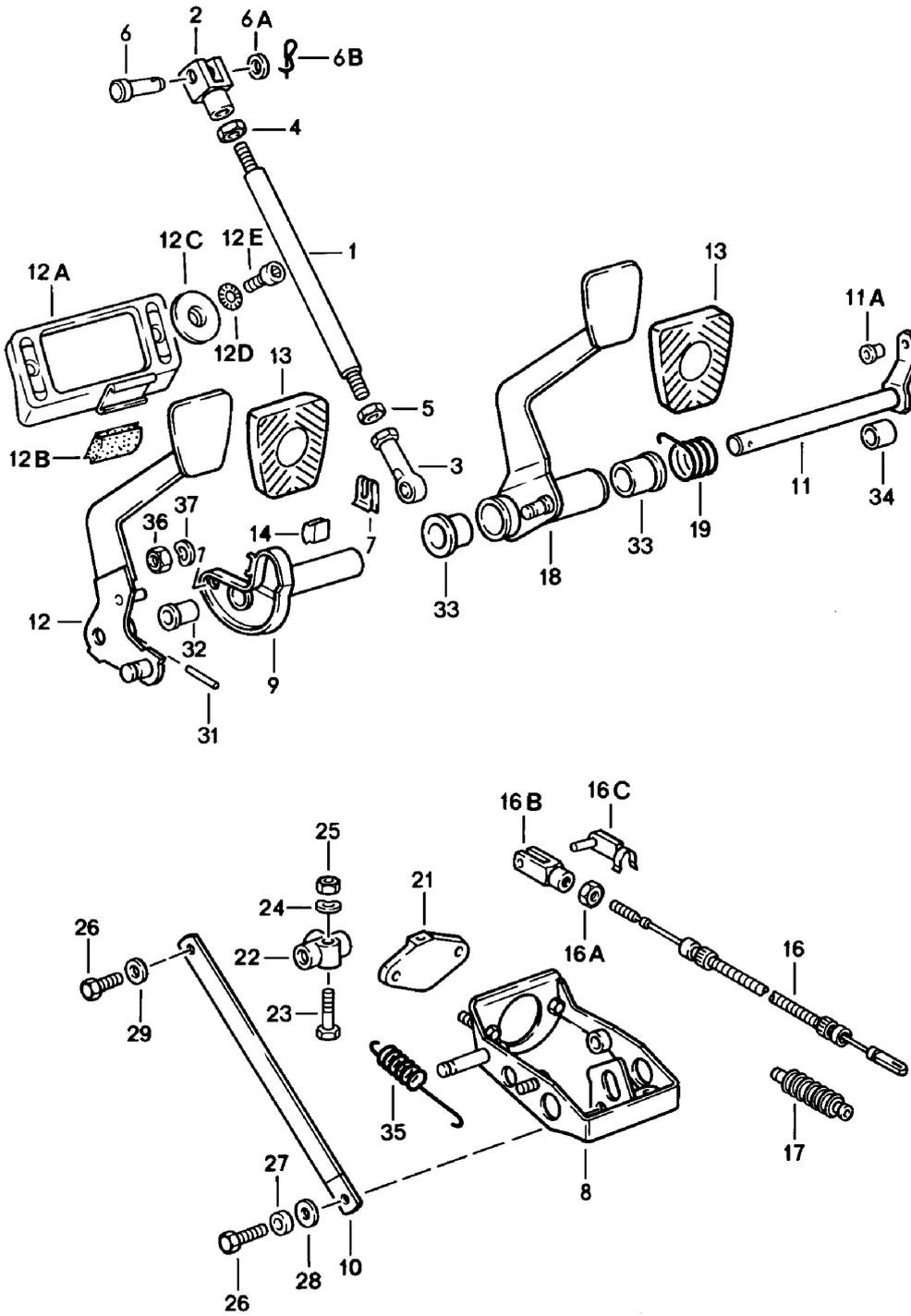

Model: 911 78

Model life 1978>>1983

Pos	Part Number	Description	Remark	Qty	Model
		Pedals	/RL		
1	911 423 523 01	Push rod		1	
2	999 166 039 02	Clevis		1	
3	999 593 116 02	Swivel head		1	
4	900 157 002 02	Hexagon nut M 10		1	
4	900 157 002 03	Hexagon nut M 10		1	
5	900 157 003 02	Hexagon nut M 10		1	
6	900 087 037 02	Bolt 10 H 11 X 28 X 23,5		1	
6A	900 031 005 02	Washer 10,5		1	
6A	900 031 005 03	Washer 10,5		1	
6B	999 021 001 07	Connector		1	
7	999 166 034 02	Sl-lock		1	
8	911 423 066 01	Bearing bracket		1	
-	PCG 911 423 00	Kit Bush Pedals Comprising:		1	
-	900 021 008 00	Cotter pin		1	
-	900 021 008 0A	Cotter pin		1	
-	999 166 001 02	Bolt		1	
-	900 309 002 00	Roll pin		1	
-	901 423 193 00	Rubber stop		1	
-	914 423 210 00	Rubber pad		2	
-	901 423 253 00	Bearing sleeve		2	
-	911 423 341 01	Bush		2	
-	901 423 343 00	Bush		2	
-	901 423 391 00	Rubber stop		1	
-	911 423 542 00	Bush		2	
9	901 423 034 00	Bearing tube		1	
(9)	925 423 035 00	Bearing tube		1	SC/SPM
10	911 423 086 00	Tension strut		1	
11	911 423 028 06	Clutch pedal shaft		1	
11A	901 423 343 00	Bush		1	
12	911 423 078 03	Clutch pedal		1	
12A	901 423 036 00	Stop		1	
12B	901 423 391 00	Rubber stop		1	
12C	901 423 368 00	Desk pad		2	
12D	N 012 130 2	Shake-proof washer		2	
12E	900 119 001 02	Pan-head screw M 5 X 12		2	
12E	900 976 003 01	Pan-head screw M 5 X 12		2	
13	914 423 210 00	Rubber pad		2	
13	905 423 511 00	Rubber pad		1	SC/SPM
14	901 423 391 00	Rubber stop		1	
16	930 423 401 05	Clutch cable		1	SC
16	930 423 401 09	Clutch cable		1	SC
16	930 423 401 06	Clutch cable		1	TURBO
16	930 423 401 10	Clutch cable		1	TURBO
16A	900 076 010 02	Nut M 6		2	
16A	900 076 010 0B	Nut M 6		2	
16B	900 166 002 02	Clevis G 6 X 24		1	
16B	900 166 002 01	Clevis G 6 X 24		1	

Model: 911 78

Model life 1978>>1983

Pos	Part Number	Description	Remark	Qty	Model
16C	999 166 001 02	Bolt 6 X 24		1	
-	999 512 291 02	Hose clamp		1	
17	311 713 269 A	Bellows		1	
18	911 423 054 01	Brake pedal		1	
18	925 423 054 00	Brake pedal		1	SC/SPM
19	911 423 532 01	Return spring		1	
19	911 423 532 02	Return spring		1	
21	911 423 153 00	Cover plate	-79	1	
22	914 355 667 00	Distributor		1	
23	900 075 341 02	Combination screw M 6 X 25		1	
23	900 075 341 01	Combination screw M 6 X 25		1	
24	N 011 524 7	Washer		1	
24	N 011 524 27	Washer		1	
25	900 076 010 02	Nut M 6		1	
25	900 076 010 0B	Nut M 6		1	
26	900 075 072 02	Hexagon-head bolt M 10 X 18		2	
27	900 027 016 02	Lock ring B 10		1	
27	900 027 016 03	Lock ring B 10		1	
28	900 025 008 09	Washer 10,5		1	
28	900 025 008 04	Washer 10,5		1	
29	900 028 032 02	Spring washer B 10		1	
31	900 309 002 00	Roll pin 6 X 28		1	
32	911 423 341 01	Bush		1	
33	911 423 542 00	Bush		2	
34	911 423 219 03	Spacer sleeve		1	
35	911 423 306 01	Tension spring		1	TURBO
(35)	911 423 306 02	Tension spring		1	SC
36	N 011 118 11	Hexagon nut M 8		1	
36	900 034 001 05	Hexagon nut M 8		1	
37	900 027 015 02	Lock ring B 8		1	
37	900 027 015 03	Lock ring B 8		1	

Model: 911 78

Model life 1978>>1983

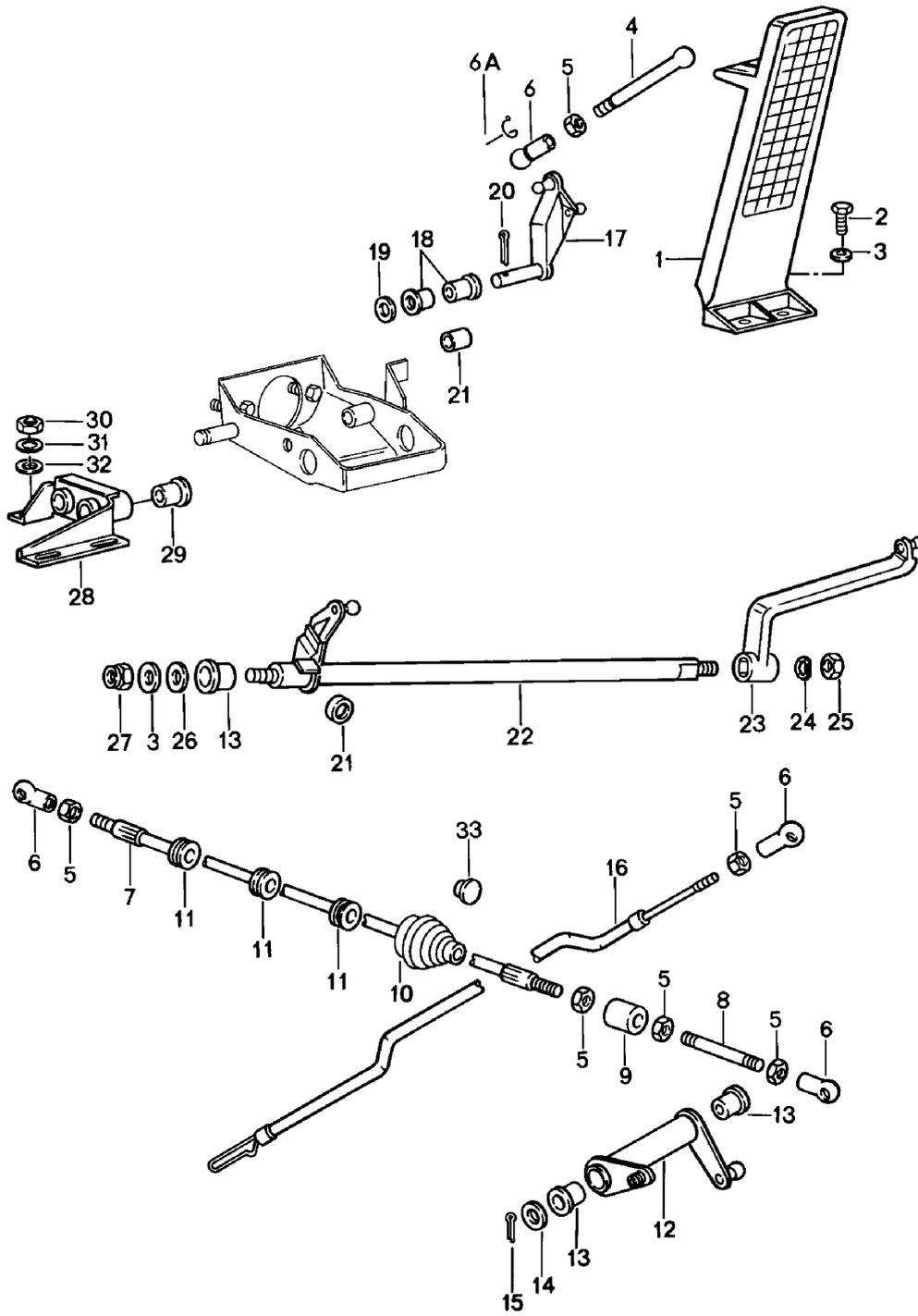

Model: 911 78 Model life 1978>>1983

Pos	Part Number	Description	Remark	Qty	Model
		Pedals			
		Accelerator control			
1	911 423 111 02	Accelerator pedal		1	
1	911 423 111 03	Accelerator pedal		1	
2	N 010 215 13	Hexagon-head bolt		2	
		M 6 X 15			
3	N 011 666 7	Washer		2	
		B 6,4			
4	914 423 227 00	Push rod		1	
4	914 423 227 01	Push rod		1	
5	900 076 027 02	Nut		6	
		M 5			
5	N 011 005 14	Hexagon nut		6	
		M 5			
5	900 076 091 01	Hexagon nut		6	
		M 5			
6	911 423 147 00	Ball socket		4	
6A	900 169 014 02	Securing clip		1	
6A	900 169 014 01	Securing clip		1	
7	PCG 423 024 00	Throttle linkage		1	
8	901 423 223 01	Extension rod		1	
9	911 423 081 02	Housing		1	
10	911 423 593 01	Sealing sleeve		1	
11	901 423 227 00	Bush		3	
12	911 423 017 01	Reverse lever		1	SC
		Use also:			
		911.423.227.00			
		900.910.096.02			
(12)	930 423 017 01	Reverse lever		1	TURBO
13	914 423 211 00	Bearing sleeve		2	
14	900 025 008 02	Washer		1	
		10,5			
14	900 025 008 09	Washer		1	
		A 10,5			
14	900 025 008 04	Washer		1	
		A 10,5			
15	N 012 530 1	Cotter pin		1	
		3,2 X 15			
16	911 423 043 00	Throttle linkage		1	SC
(16)	930 423 019 02	Throttle linkage		1	TURBO
(16)	925 423 026 01	Throttle linkage		1	SC/SPM
17	901 423 250 02	Reverse lever		1	
18	901 423 253 00	Bearing sleeve		2	
19	900 025 007 02	Washer		1	
		8,4			
19	900 025 007 03	Washer		1	
		8,4			
20	900 021 008 00	Cotter pin		1	
20	900 021 008 0A	Cotter pin		1	
21	901 423 193 00	Rubber stop		1	
22	901 423 556 00	Shaft	/RL	1	
23	901 423 022 00	Lever	/RL	1	
24	N 011 524 7	Washer	/RL	1	
24	N 011 524 27	Washer	/RL	1	
25	900 076 010 02	Nut	/RL	1	
		M 6			
25	900 076 010 0B	Nut	/RL	1	
		M 6			
26	911 423 225 00	Washer	/RL	3	
27	900 084 010 02	Lock nut	/RL	1	
		M 6			
28	901 423 013 00	Bearing bracket	/RL	1	
29	911 423 341 01	Bush	/RL	1	

Model: 911 78

Model life 1978>>1983

Pos	Part Number	Description	Remark	Qty	Model
30	900 076 025 02	Hexagon nut M 8	/RL	5	
30	900 076 064 02	Hexagon nut M 8	/RL	5	
31	900 027 015 02	Lock ring B 8	/RL	5	
31	900 027 015 03	Lock ring B 8	/RL	5	
32	900 025 007 02	Washer 8,4	/RL	6	
32	900 025 007 03	Washer 8,4	/RL	6	
33	999 703 005 40	Stopper Clutch tube		1	SC/SPM
33	999 703 058 40	Stopper for Clutch tube		1	SC/SPM

Model: 911 78

Model life 1978>>1983

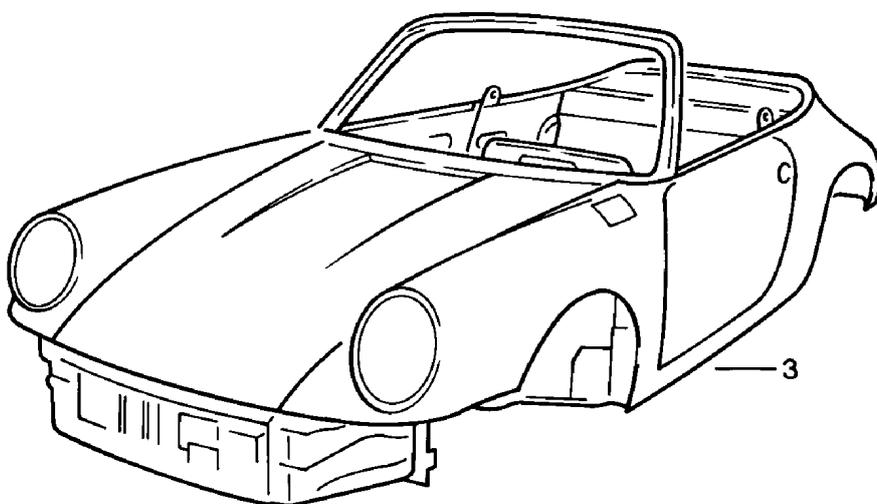
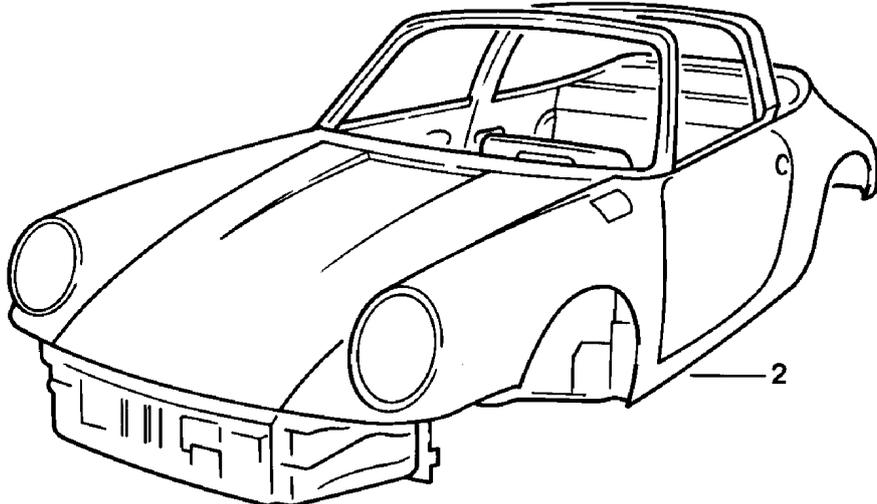
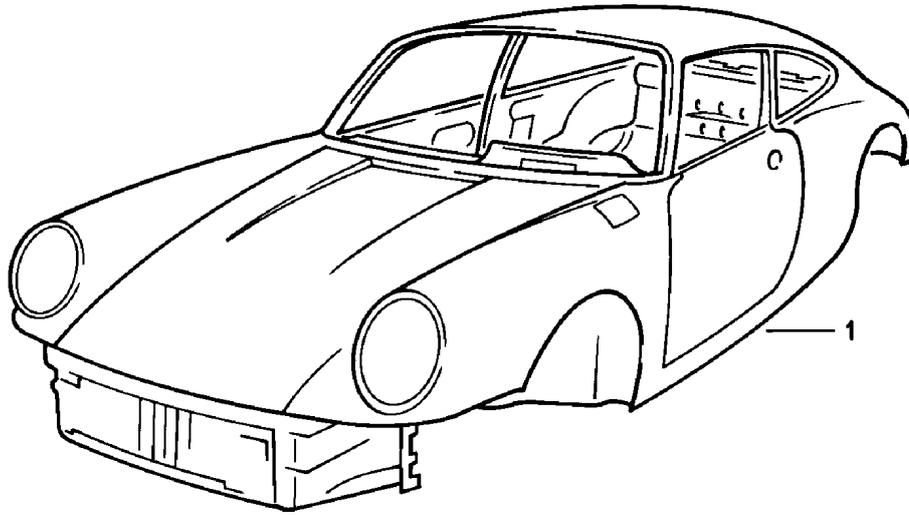

Model: 911 78

Model life 1978>>1983

Pos	Part Number	Description	Remark	Qty	Model
		Body in white Prime coated Sealed with Underbody protection Bodyshells can only only available from current			
1	911 500 921 27	Body in white	/LL	1	CARRERA COUPE
(1)	911 500 921 28	Body in white	/RL	1	CARRERA COUPE
(1)	930 500 921 06	Body in white	/LL	1	TURBO COUPE
(1)	930 500 921 07	Body in white	/RL	1	TURBO COUPE
2	911 500 921 64	Body in white	/LL	1	TARGA
(2)	911 500 921 65	Body in white	/RL	1	TARGA
3	911 500 921 67	Body in white	/LL	1	CABRIO
(3)	911 500 921 68	Body in white	/RL	1	CABRIO

Model: 911 78

Model life 1978>>1983

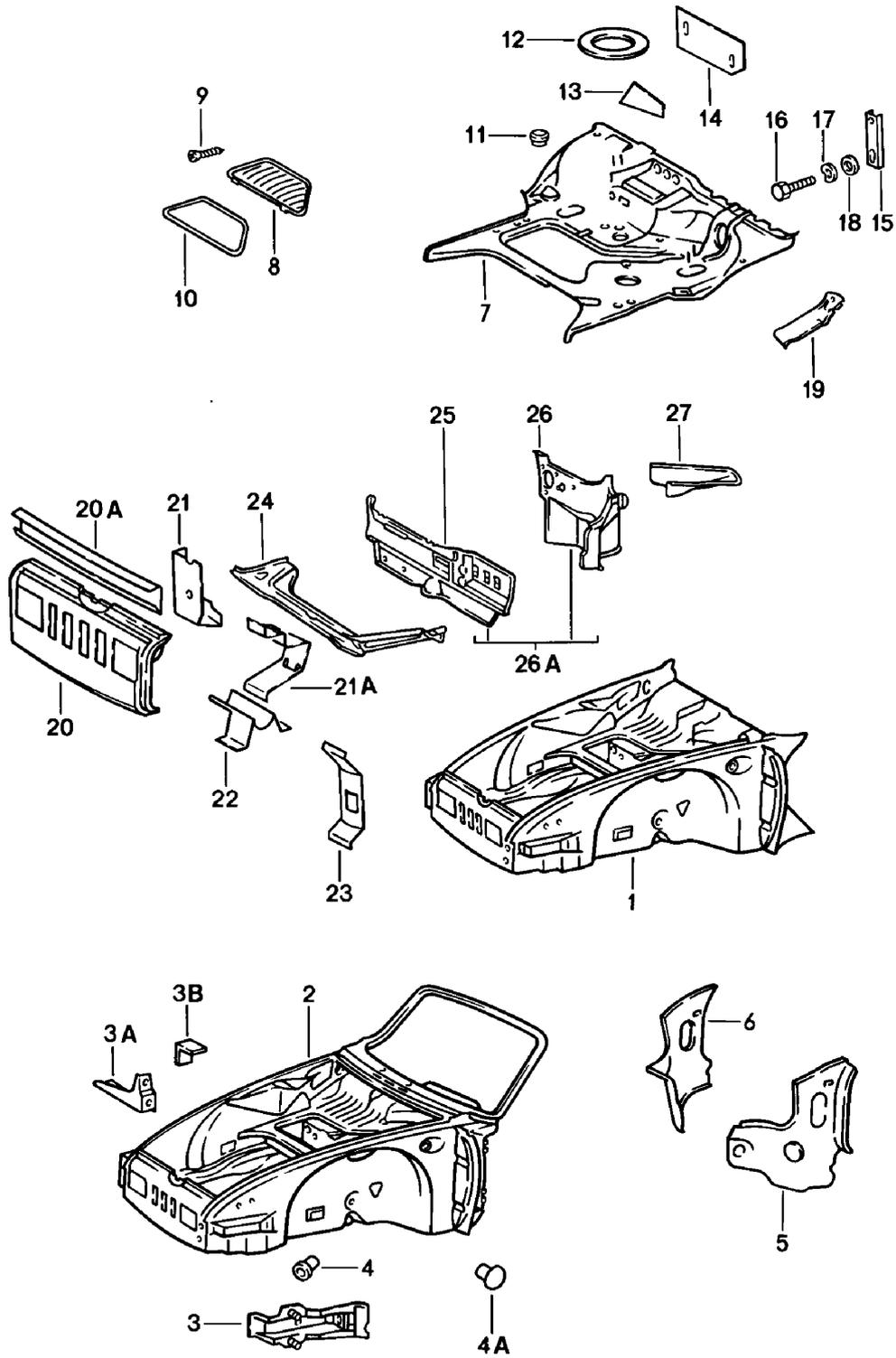

Model: 911 78 Model life 1978>>1983

Pos	Part Number	Description	Remark	Qty	Model
1	911 501 005 31	Frame Front Body front section See technical information NR. 19	/LL	1	SC COUPE
(1)	930 501 005 06	Body front section See technical information NR. 19	/LL	1	TURBO
(1)	911 501 005 32	Body front section	/RL	1	SC COUPE
(1)	930 501 005 07	Body front section	/RL	1	TURBO
2	911 501 005 50	Body front section	/LL	1	TARGA CABRIO
(2)	911 501 005 51	Body front section	/RL	1	TARGA CABRIO
3	911 501 149 00	Support	/L	1	
3	911 501 149 02	Support	/L	1	
3		Impact absorber			
3		Support	/L	1	
	911 501 149 02 GRV	Prime coated			
		Impact absorber			
(3)	911 501 150 00	Support	/R	1	
(3)	911 501 150 02	Support	/R	1	
		Impact absorber			
(3)		Support	/R	1	
	911 501 150 02 GRV	Prime coated			
		Impact absorber			
3A	911 501 490 01	Bracket	80-	1	
		Lower			
3A		Bracket	80-	1	
	911 501 490 01 GRV	Prime coated			
		Lower			
3B	911 503 492 01	Bracket	80-	1	
		Upper			
3B	911 503 292 00	Bracket	80-	1	
	911 503 292 00 GRV	Prime coated			
		Upper			
4	111 971 911 A	Grommet		1	
		15 \$			
5	901 501 917 43	Gusset plate	/LL /L	1	TARGA CABRIO
6	901 501 918 43	Gusset plate	/LL /R	1	TARGA CABRIO
(6)	911 501 130 41	Gusset plate	/RL /R	1	TARGA CABRIO
7	911 501 035 13	Boot floor plate	/LL	1	
7		Boot floor plate	/LL	1	
	911 501 035 13 GRV	Prime coated			
(7)	911 501 036 06	Boot floor plate	/RL	1	
8	901 504 043 02	Cover	/LL	1	
8	911 504 043 01	Lid	/LL	1	
8		Lid	/LL	1	
	911 504 043 01 GRV				
(8)	911 504 044 00	Lid	/RL	1	
(8)		Lid	/RL	1	
	911 504 044 00 GRV	Prime coated			
9	900 144 034 07	Tapping screw		4	
9	900 144 034 0G	Tapping screw		4	
9	900 144 034 07	Tapping screw		4	
		B 4,2 X 16			
9	900 144 034 0G	Tapping screw		4	
		B 4,2 X 16			
10	911 504 491 02	Gasket	/LL	1	
(10)	901 504 491 32	Gasket	/RL	1	

Model: 911 78 Model life 1978>>1983

Pos	Part Number	Description	Remark	Qty	Model
11	999 703 103 40	Stopper 23,5 \$		1	
12	911 504 405 00	Covering		1	
13	911 556 229 00	Desk pad	/RL	1	
14	911 504 118 00	Cover	/RL	1	
15	911 501 347 00	Cowl panel support	/LL	1	
(15)	911 501 409 00	Cowl panel support	/RL	1	
16	900 075 260 02	Hexagon-head bolt M 6 X 16		2	
17	N 012 006 4	Lock ring B 6		2	
18	N 011 524 7	Washer		2	
18	N 011 524 27	Washer		2	
18	N 011 524 7	Washer 6,4		2	
18	N 011 524 27	Washer 6,4		2	
19	911 501 411 00	Connecting piece	/L	1	SC COUPE
19	901 501 411 21	Connecting piece Boot floor plate Wheel housing	/L	1	SC COUPE
(19)	901 501 412 21	Connecting piece Boot floor plate Wheel housing	/R	1	SC COUPE
(19)	901 501 411 41	Connecting piece Boot floor plate Wheel housing	/L	1	TARGA CABRIO
(19)	901 501 412 41	Connecting piece Boot floor plate Wheel housing	/R	1	TARGA CABRIO
20	911 501 099 04	Cross panel		1	
20	911 501 099 06	Cross panel		1	
20	911 501 099 06 GRV	Cross panel Prime coated		1	
(20)	911 501 099 07	Cross panel		1	M559
(20)	911 501 099 07 GRV	Cross panel Prime coated		1	M559
20A	911 501 395 00	Sealing rail		1	
20A	911 501 395 00 GRV	Sealing rail Prime coated		1	
21	911 501 397 00	Support Jack	/R	1	
21	911 501 397 00 GRV	Support Prime coated Jack	/R	1	
21A	911 501 387 01	Support Jack Centre		1	
21A	911 501 387 01 GRV	Support Prime coated Jack Centre		1	
22	911 501 273 00	Mounting Water pump	-79	1	SC M559
22	911 501 273 00 GRV	Mounting Prime coated for Water pump		1	SC M559
23	911 501 275 00	Support Water pump	-79	1	SC M288

Model: 911 78

Model life 1978>>1983

Pos	Part Number	Description	Remark	Qty	Model
23		Support		1	SC
	911 501 275 00 GRV	Prime coated Water pump			M288
24	911 501 117 02	Fuel tank support holder		1	
24		Fuel tank support holder		1	
	911 501 117 02 GRV	Prime coated			
25	911 501 213 01	Cross panel	/LL	1	
25	901 501 041 35	Cross panel	/LL	1	
26	901 501 043 33	Box wall	/LL	1	
26A	911 501 132 00	Cross panel	/RL	1	
26A		Cross panel	/RL	1	
	911 501 132 00 GRV	Prime coated			
27	901 501 354 32	Cup	/LL	1	
(27)	911 501 356 00	Cup	/RL	1	
(27)		Cup	/RL	1	
	911 501 356 00 GRV	Prime coated			
-	927 631 224 01	Grommet Deleted Oxygen sensor	80-	1	SC

Model: 911 78

Model life 1978>>1983

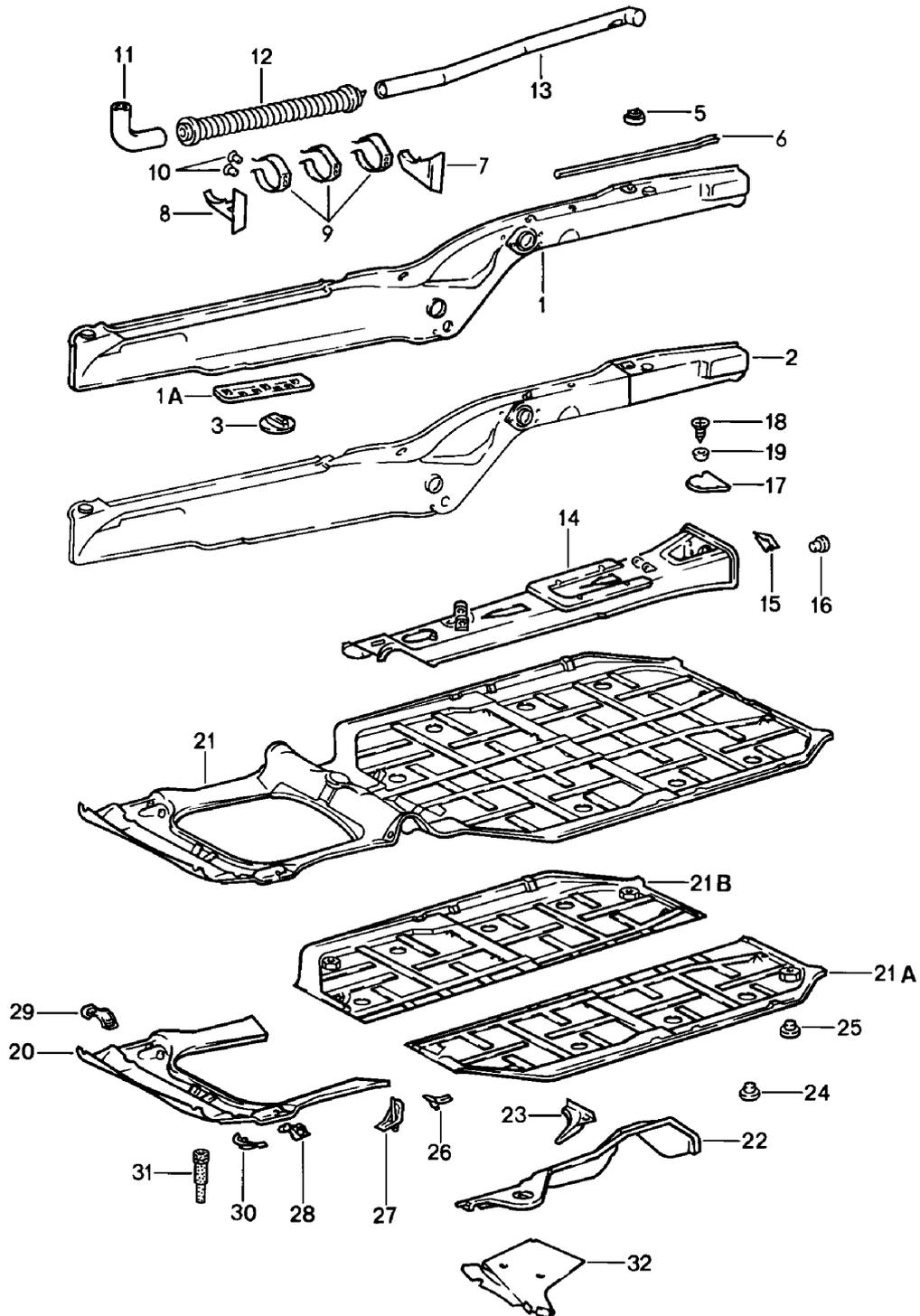

Model: 911 78 Model life 1978>>1983

Pos	Part Number	Description	Remark	Qty	Model
1	911 501 962 26	Frame Centre Side member	/R	1	COUPE
(1)	911 501 962 46	Inner Side member	/R	1	TARGA
(1)	901 501 962 43	Side member	/R	1	
(1)	911 501 961 25	Inner Side member	/L	1	COUPE
(1)	911 501 961 45	Inner Side member	/L	1	TARGA
(1)	901 501 961 43	Side member	/L	1	
1A	911 501 266 00	Inner Seat rail support	/R	1	
1A	911 501 268 02	Seat rail support	/R	1	
(1A)	911 501 265 00	Outer Seat rail support	/L	1	
(1A)	911 501 267 02	Seat rail support	/L	1	
2	911 501 962 03	Outer Side member	/R	1	
(2)	911 501 961 03	Inner Sub-part Side member	/L	1	
(2)	911 501 961 05	Side member	/L	1	
(2)	911 501 961 05 GRV	Inner Sub-part Side member	/L	1	
3	111 801 177	Prime coated Inner Sub-part Rubber valve		3	
5	901 501 117 20	Mounting plate		2	
6	901 501 796 20	Profile rail	/R	1	SC
6	901 501 796 20 GRV	Profile rail	/R	1	SC
(6)	930 501 792 00	Prime coated Profile rail	/R	1	TURBO
(6)	930 501 792 00 GRV	Profile rail	/R	1	TURBO
(6)	901 501 795 20	Prime coated Profile rail	/L	1	SC
(6)	901 501 795 20 GRV	Profile rail	/L	1	SC
(6)	930 501 791 00	Prime coated Profile rail	/L	1	TURBO
(6)	930 501 791 00 GRV	Profile rail	/L	1	TURBO
7	901 501 263 20	Prime coated Pipe bracket		2	
8	901 501 264 20	Pipe bracket		2	
9	901 501 128 20	Retainer spring		6	
9	901 501 128 20 GRV	Retainer spring		6	
10	N 013 411 1	Prime coated Rivet		12	
10		Rivet		12	
11	911 572 211 01	3 X 6 Hot air duct		2	
11		Hot air duct		2	
(12)	911 572 025 02	Muffler		2	
13	911 572 024 00	Not Closed Hot air duct	/R	1	
13	911 572 222 02	Hot air duct	/R	1	
(13)	911 572 221 02	Hot air duct	/L	1	
(13)		Hot air duct	/L	1	
14	911 501 061 47	Tunnel	/LL	1	
(14)	911 501 062 46	with tubes Tunnel	/RL	1	

Model: 911 78 Model life 1978>>1983

Pos	Part Number	Description	Remark	Qty	Model
15	911 501 661 00	with tubes Cross tube reinforcement	/L	1	
(15)	911 501 662 00	Cross tube reinforcement	/R	1	
16	914 552 233 10	Filler piece		1	SC
16		Filler piece		1	SC
	914 552 233 10 01C	Black			
16	914 552 233 10	Filler piece		1	SC
	914 552 233 10 01C	Black			
		10 \$			
16	914 552 233 10	Filler piece		1	SC
	914 552 233 10 01C	Black			
		10 \$			
17	901 504 731 30	Lid		1	
18	900 143 019 07	Oval-head sheetmetal screw		4	
		B 4,8 X 22			
19	900 031 006 07	Washer		4	
		5,3			
-	999 591 329 02	Prestole cage		4	
		B 4,8			
(20)	911 501 955 00	Tank compartment floor		1	
(20)		Tank compartment floor		1	
	911 501 955 00 GRV	Prime coated			
21A	911 501 935 00	Floorpan	/LL /L	1	
21A		Floorpan	/LL /L	1	
	911 501 935 00 GRV	Prime coated			
21B	911 501 936 00	Floorpan	/LL /R	1	
21B		Floorpan	/LL /R	1	
	911 501 936 00 GRV	Prime coated			
21	911 501 051 12	Floorpan	/LL 83	1	SC
21		Floorpan	/LL 83-	1	SC
		Complete			
	911 501 051 12 GRV	Prime coated			
21	930 501 051 04	Floorpan	/LL	1	TURBO
21	911 501 052 12	Floorpan	/RL	1	SC
21	930 501 052 05	Floorpan	/RL	1	TURBO
21		Floorpan	/RL	1	TURBO
		Complete			
	930 501 052 05 GRV	Prime coated			
22	911 501 111 02	Fuel tank support holder	/L	1	
22		Fuel tank support holder	/L	1	
	911 501 111 02 GRV	Prime coated			
(22)	911 501 114 04	Fuel tank support holder	/R	1	
(22)		Fuel tank support holder	/R	1	
	911 501 114 04 GRV	Prime coated			
23	901 501 457 20	Bracket	/L	1	
23		Bracket	/L	1	
	901 501 457 20 GRV	Prime coated			
(23)	901 501 458 20	Bracket	/R	1	
(23)		Bracket	/R	1	
	901 501 458 20 GRV	Prime coated			
24	999 703 121 40	Stopper		20	
		8 \$			
25	999 703 125 40	Stopper		4	
		8,9 \$			
26	901 501 063 23	Bracket		2	
27	901 501 359 01	Axle mounting	/V /L	1	SC
27		Axle mounting	/V /L	1	SC
		Left			
	901 501 359 01 GRV	Prime coated			
(27)	930 501 359 01	Axle mounting	/V /L	1	TURBO
(27)	901 501 360 01	Axle mounting	/V /R	1	SC
(27)		Axle mounting	/V /R	1	SC
		Right			

Model: 911 78 Model life 1978>>1983

Pos	Part Number	Description	Remark	Qty	Model
	901 501 360 01 GRV	Prime coated			
(27)	930 501 360 01	Axle mounting	/V /R	1	TURBO
28	901 501 409 23	Reinforcement plate	/L	1	
28		Reinforcement plate	/L	1	
	901 501 409 23 GRV	Prime coated			
(28)	901 501 410 23	Reinforcement plate	/R	1	
(28)		Reinforcement plate	/R	1	
	901 501 410 23 GRV	Prime coated			
29	901 501 427 21	Reinforcement		2	
	901 501 427 21 GRV	Prime coated			
		Axle mounting			
30	901 501 407 22	Corner reinforcement	/L	1	
30		Corner reinforcement	/L	1	
	901 501 407 22 GRV	Prime coated			
(30)	901 501 408 22	Corner reinforcement	/R	1	
(30)		Corner reinforcement	/R	1	
	901 501 408 22 GRV	Prime coated			
31	911 025 612 00	Grommet		2	
32	911 501 285 00	Carrier plate for battery		1	
32		Carrier plate for battery		1	
	911 501 285 00 GRV	Prime coated			

Model: 911 78

Model life 1978>>1983

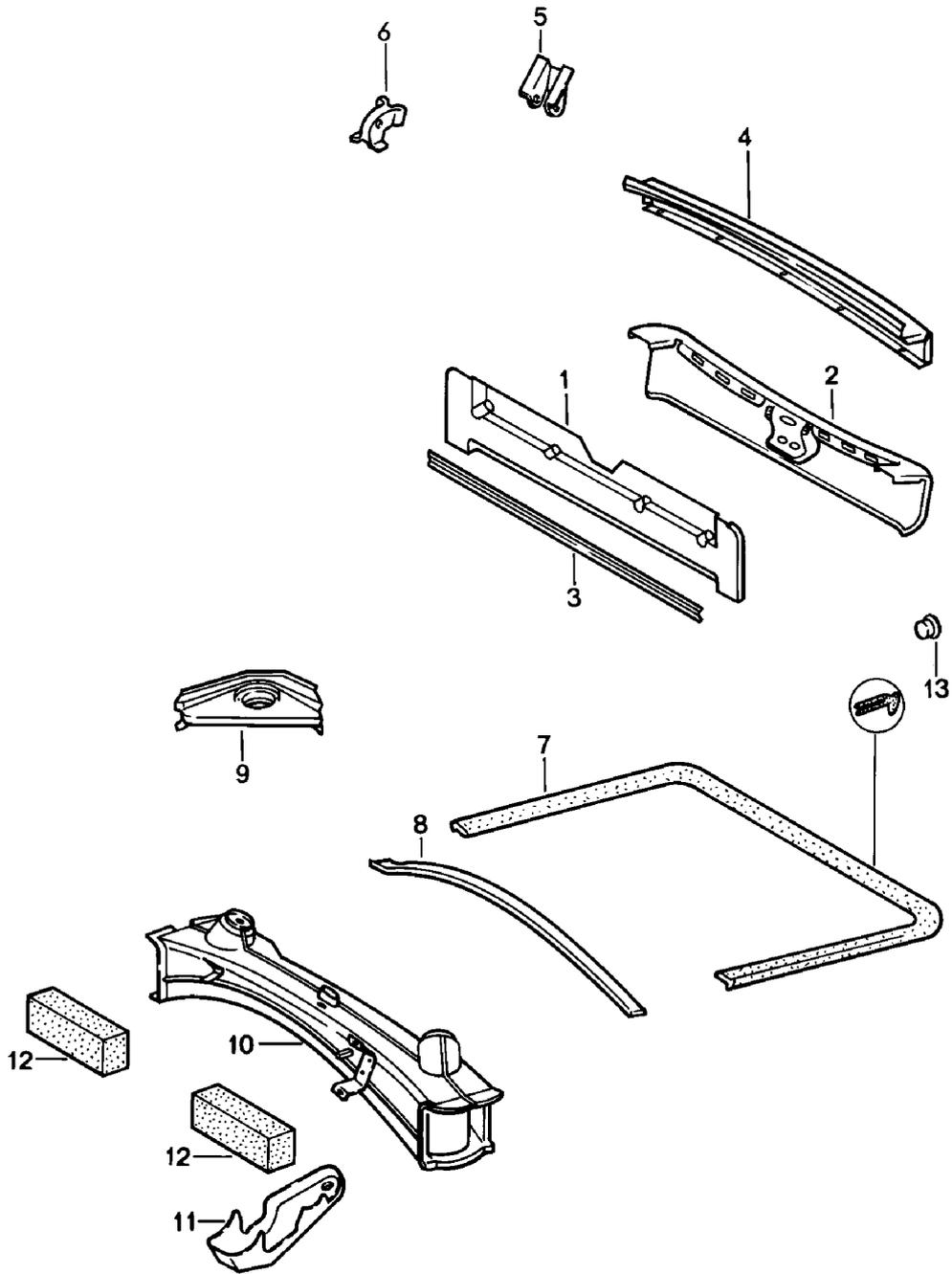

Model: 911 78 Model life 1978>>1983

Pos	Part Number	Description	Remark	Qty	Model
		Frame			
		Rear			
1	911 501 830 01	Cross member		1	SC
(1)	911 507 080 00	Cross member		1	SC
(1)	911 507 080 01	Cross member		1	SC
(1)		Cross member		1	SC
	911 507 080 01 GRV	Prime coated			
(1)	930 501 085 00	Cross member		1	TURBO
(1)	930 501 080 00	Cross member		1	TURBO
2	901 501 087 22	Cross member		1	SC
(2)	911 507 080 00	Cross member		1	SC
(2)	911 507 080 01	Cross member		1	SC
(2)		Cross member		1	SC
	911 507 080 01 GRV	Prime coated			
(2)	930 501 086 00	Cross member		1	TURBO
(2)	930 501 080 00	Cross member		1	TURBO
3	901 501 797 20	Profile rail		1	SC
(3)		It is necessary to rework			TURBO
		Profile rail		1	TURBO
4	911 503 151 00	End plate		1	
4		End plate		1	
	911 503 151 00 GRV	Prime coated			
5	911 501 729 00	Bracket	-82	2	
5	911 501 729 01	Pneumatic spring mount		2	
5		Pneumatic spring mount		2	
	911 501 729 01 GRV	Prime coated			
6	911 501 041 00	Bearing		1	COUPE/TARGA
6	911 501 041 60	Bearing		1	CABRIO
7	911 504 111 02	Engine compartment seal		1	SC
(7)	930 504 170 01	Engine compartment seal		1	TURBO
8	911 504 113 02	Engine compartment seal		1	SC
(8)	911 504 115 02	Engine compartment seal	-80	1	TURBO
(8)		Engine compartment seal	81-	1	TURBO
9	901 501 083 21	Engine mounting		2	
9		Engine mounting		2	
	901 501 083 21 GRV	Prime coated			
10	911 501 075 06	Cross member		1	
10	911 501 075 07	Cross member		1	
10		Cross member		1	
		Rear			
		for			
		Suspension strut mounting			
	911 501 075 07 GRV	Prime coated			
11	911 501 023 02	Bracket		1	TURBO
		Fuel pump			
11		Bracket		1	TURBO
	911 501 023 02 GRV	Prime coated			
		Fuel pump			
12	911 504 930 00	Strap		2	
13	999 703 098 40	Stopper		2	
		19 \$			

Model: 911 78

Model life 1978>>1983

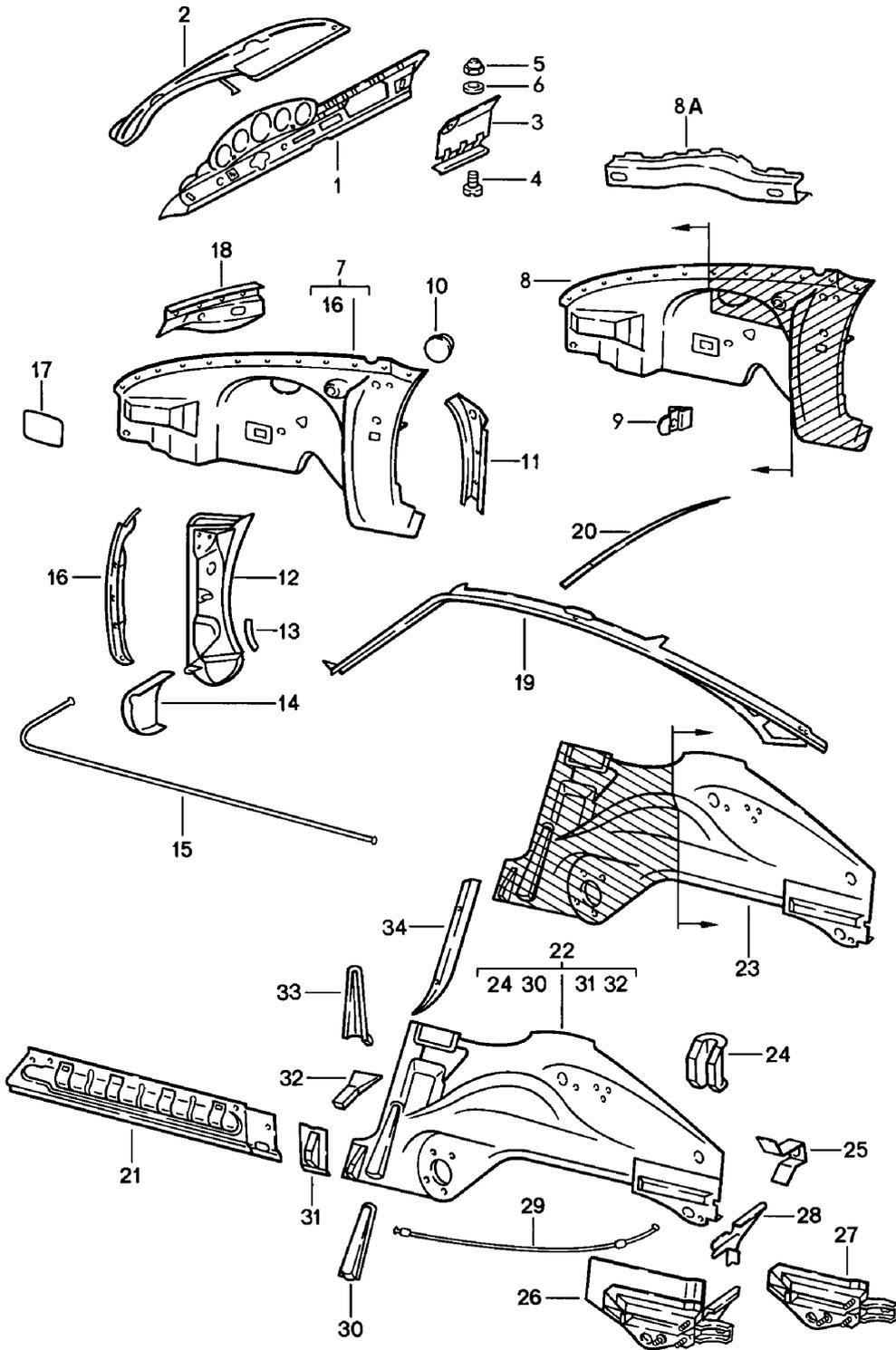

Model: 911 78 Model life 1978>>1983

Pos	Part Number	Description	Remark	Qty	Model
1	911 502 021 02	Interior panelling Dashboard	/LL	1	
(1)	911 502 022 34	Lower part Dashboard	/RL	1	
(1)	911 502 022 34 GRV	Lower part Dashboard Prime coated	/RL	1	
2	911 502 025 40	Lower part Dashboard	/LL	1	
2	901 502 023 44	Dashboard Upper part	/LL	1	
(2)	911 502 026 40	Dashboard	/RL	1	
(2)	901 502 024 26	Dashboard Upper part	/RL	1	
3	911 552 010 02	Glove compartment cover		1	
3	911 552 010 04	Glove compartment cover		1	
4	900 146 003 02	Oval-head screw AM 5 X 10		2	
5	N 021 196 1	Lock nut		4	
5	N 021 196 3	Hexagon nut		4	
5	N 021 196 1	Lock nut		4	
5	N 021 196 3	M 5 Hexagon nut		4	
6	900 025 003 02	M 5 Washer		4	
6		Washer 5,3		4	
7	911 501 967 00	Wheel housing	/L	1	
(7)	911 501 968 00	Wheel housing	/R	1	
8	911 501 995 02	Wheel housing	/L	1	
8	911 501 967 02	Wheel housing	/L	1	
8		Wheel housing Left	/L	1	
(8)	911 501 967 02 GRV	Prime coated			
(8)	911 501 996 02	Wheel housing	/R	1	
(8)	911 501 968 02	Wheel housing without POS. 12,16,18 See group 8/01/05 POS. 19	/R	1	
(8)	911 501 968 02 GRV	Wheel housing Prime coated without POS. 12,16,18 See group 8/01/05 POS. 19	/R	1	
9	901 501 419 00	Tab Brake hose		2	
10	999 703 031 40	Stopper 30 \$		2	
10	999 703 031 4A	Stopper 30 \$		2	
11	901 501 217 21	Post bracket	/L	1	COUPE
(11)	901 501 218 21	Post bracket	/R	1	COUPE
12	911 501 039 02	Hinge pillar	/L	1	
(12)	911 501 040 02	Hinge pillar	/R	1	
13	901 501 305 20	Angular bracket	/L	1	
13		Angular bracket	/L	1	
(13)	901 501 305 20 GRV	Prime coated			
(13)	901 501 306 20	Angular bracket	/R	1	
(13)		Angular bracket	/R	1	

Model: 911 78 Model life 1978>>1983

Pos	Part Number	Description	Remark	Qty	Model
	901 501 306 20 GRV	Prime coated			
14	911 501 439 00	Filler plate	/L	1	
14		Filler plate	/L	1	
	911 501 439 00 GRV	Prime coated			
(14)	911 501 440 00	Filler plate	/R	1	
(14)		Filler plate	/R	1	
	911 501 440 00 GRV	Prime coated			
15	911 502 181 00	Guide tube		1	COUPE
		Lid-release cable			
16	911 501 053 00	Wing joining plate	/L	1	
	911 501 053 00 GRV	Prime coated			
16	911 501 053 01	Wing joining plate	/L	1	
	911 501 053 01 GRV	Prime coated			
(16)	911 501 054 00	Wing joining plate	/R	1	
	911 501 054 00 GRV				
17	911 504 101 00	Cover plate		2	
18	911 501 223 01	Reinforcing support	/L	1	
18	911 501 223 02	Reinforcement bracket	/L	1	
18		Reinforcement bracket	/L	1	
	911 501 223 02 GRV	Prime coated			
(18)	911 501 226 01	Reinforcing support	/R	1	
(18)	911 501 226 00	Reinforcing support	/R	1	
(18)		Reinforcing support	/R	1	
	911 501 226 00 GRV	Prime coated			
19	911 502 029 00	Roof frame	/L	1	COUPE
(19)	911 502 030 00	Roof frame	/R	1	COUPE
20	911 502 220 00	Cross piece for windscreen		1	
20		Cross piece for windscreen		1	
	911 502 220 00 GRV	Prime coated			
21	911 501 123 03	Side member	/L	1	
(21)	911 501 124 03	Side member	/R	1	
(21)	911 501 124 04	Side member	/R	1	
(21)	964 501 136 00	Side member	/R	1	
(21)		Side member	/R	1	
		Floor			
		Right			
		Outer			
	964 501 136 00 GRV	Prime coated			
22	911 501 017 20	Side member	/L	1	COUPE
22	911 501 017 21	Side member	/L	1	COUPE
		Wheel housing			
23	911 501 997 02	Side member	/L	1	COUPE
23	911 501 997 03	Side member	/L	1	COUPE
(22)	911 501 018 30	Side member	/R	1	COUPE
		Wheel housing			
(23)	911 501 998 02	Side member	/R	1	COUPE
24	911 501 115 00	Reinforcement		2	
24		Reinforcement		2	
	911 501 115 00 GRV	Prime coated			
25	911 501 125 00	Threaded support		6	
25		Threaded support		6	
	911 501 125 00 GRV	Prime coated			
26	911 501 921 01	Mounting	/L	1	
(26)	911 501 922 00	Mounting	/R	1	
27	911 501 167 00	Mounting	/L -82	1	
27	911 501 167 03	Mounting	/L 83-	1	
27		Mounting	/L 83-	1	
	911 501 167 03 GRV	Prime coated			
(27)	911 501 168 00	Mounting	/R	1	
(27)		Mounting	/R	1	
	911 501 168 00 GRV	Prime coated			
28	911 501 313 00	Corner reinforcement	/L	1	
(28)	911 501 314 00	Corner reinforcement	/R	1	

Model: 911 78 Model life 1978>>1983

Pos	Part Number	Description	Remark	Qty	Model
(28)		Corner reinforcement	/R	1	
	911 501 314 00 GRV	Prime coated			
29	911 502 483 00	Guide tube		1	
		Lid-release cable			
30	901 501 145 23	Bracket	/L	1	
30		Bracket	/L	1	
	901 501 145 23 GRV	Prime coated			
(30)	901 501 146 23	Bracket	/R	1	
(30)		Bracket	/R	1	
	901 501 146 23 GRV	Prime coated			
31	901 501 151 22	Mounting		1	
31		Mounting		1	
	901 501 151 22 GRV	Prime coated			
32	911 501 195 00	Jacking point		1	
33	901 501 141 21	Bracket	/L	1	COUPE
(33)	911 501 823 00	Bracket	/L	1	COUPE
(33)		Bracket	/L	1	COUPE
		Left			
	911 501 823 00 GRV	Prime coated			
(33)	901 501 142 21	Bracket	/R	1	COUPE
(33)	911 501 824 00	Bracket	/R	1	COUPE
(33)		Bracket	/R	1	COUPE
	911 501 824 00 GRV	Prime coated			
34	901 502 245 00	Profile	/L	1	COUPE
(34)	901 502 246 00	Profile	/R	1	COUPE

Model: 911 78

Model life 1978>>1983

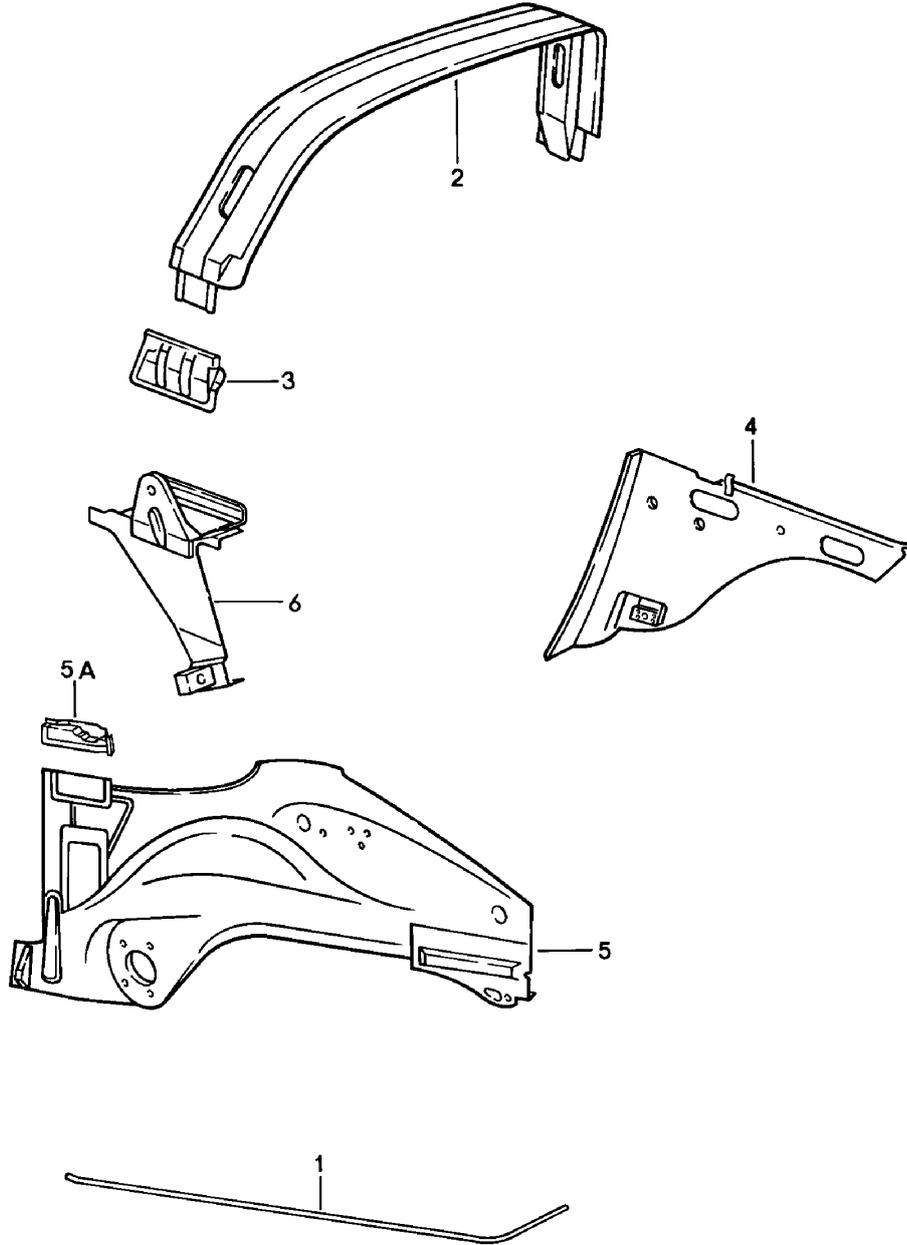

Model: 911 78 Model life 1978>>1983

Pos	Part Number	Description	Remark	Qty	Model
1	911 502 181 40	Interior panelling Guide tube	/V	1	TARGA/CABRIO
1	911 502 181 40 GRV	Lid-release cable Guide tube Prime coated	/V	1	
2	911 565 001 40	Lid-release cable Roll bar		1	TARGA
3	911 501 203 40	Filler plate	/L	1	TARGA
3	911 501 203 40 GRV	Filler plate Prime coated	/L	1	TARGA
(3)	911 501 204 40	Filler plate	/R	1	TARGA
(3)	911 501 204 40 GRV	Filler plate Prime coated	/R	1	TARGA
4	911 501 205 41	Rear bulkhead	/L	1	TARGA
4	911 501 205 41 GRV	Rear bulkhead Prime coated	/L	1	TARGA
(4)	911 501 205 60	Rear bulkhead	/L	1	CABRIO
(4)	911 501 205 60 GRV	Rear bulkhead Prime coated	/L	1	CABRIO
(4)	911 501 206 41	Rear bulkhead	/R	1	TARGA
(4)	911 501 206 41 GRV	Rear bulkhead Prime coated	/R	1	TARGA
(4)	911 501 206 60	Rear bulkhead	/R	1	CABRIO
(4)	911 501 206 60 GRV	Rear bulkhead Prime coated	/R	1	CABRIO
5	911 501 017 56	Side member	/L	1	TARGA
5	911 501 017 57	Side member	/L	1	TARGA
(5)	911 501 017 60	Wheel housing Side member	/L	1	CABRIO
(5)	911 501 017 61	Side member	/L	1	CABRIO
(5)	911 501 018 70	Wheel housing Side member	/R	1	TARGA
(5)	911 501 018 60	Wheel housing Side member	/R	1	CABRIO
5A	911 501 465 60	Wheel housing Insert	/L	1	CABRIO
5A	911 501 465 60 GRV	Insert Prime coated	/L	1	CABRIO
(5A)	911 501 466 60	Insert	/R	1	CABRIO
(5A)	911 501 466 60 GRV	Insert Prime coated	/R	1	CABRIO
6	911 501 431 60	Convertible top support	/L	1	CABRIO
6	911 501 431 60 GRV	Convertible top support Prime coated	/L	1	CABRIO
(6)	911 501 432 60	Convertible top support	/R	1	CABRIO

Model: 911 78

Model life 1978>>1983

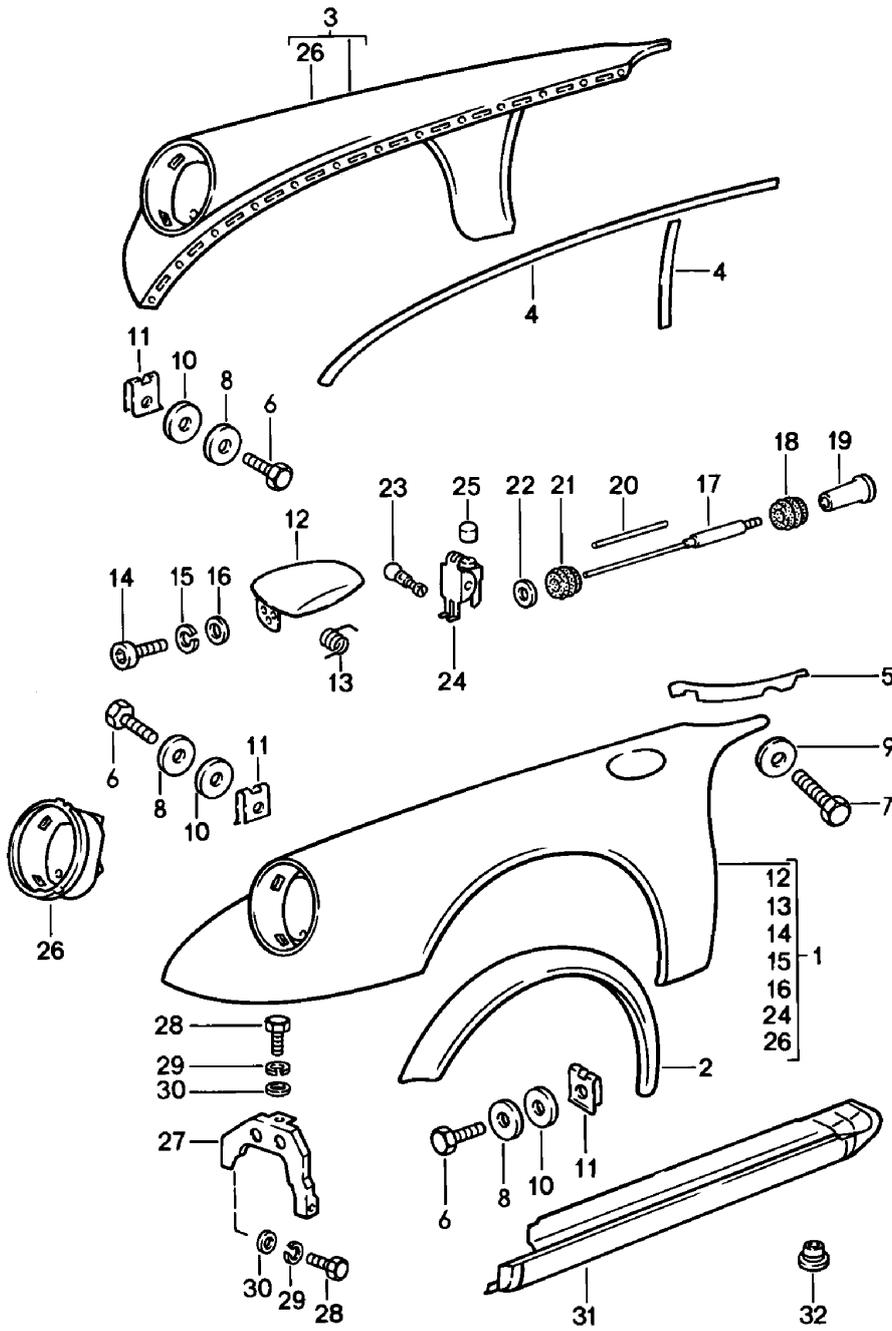

Model: 911 78 Model life 1978>>1983

Pos	Part Number	Description	Remark	Qty	Model
		Exterior panelling			
		Front			
1	911 503 031 07	Wing	/L -80	1	SC
1	911 503 031 10	Wing	/L -80	1	SC
-	911 201 077 02	Order also: Expansion tank with	81-	1	
		Bore for			
(1)	911 503 031 06	Direction indicator light Wing	/L 81- 82	1	SC
(1)	911 503 031 08	Wing	/L 81-	1	SC
(1)	911 503 031 09	Wing	/L 81-	1	SC
-	911 201 077 02	Order also: Expansion tank		1	
1	930 503 031 09	Wing with	/L -80	1	TURBO
		POS.2			
1	930 503 031 11	Wing with	/L -80	1	TURBO
		POS.2 with	81-		
		Bore for			
(1)	930 503 031 04	Direction indicator light Wing with	/L 81-	1	TURBO
		POS.2			
(1)	930 503 031 08	Wing with	/L 81-	1	TURBO
		POS.2			
2	930 503 307 00	Wing joining plate	/L	1	TURBO
(2)	930 503 308 00	Wing joining plate	/R	1	TURBO
3	911 503 032 02	Wing	/R -80	1	SC
3	911 503 032 05	Wing with	/R -80 81-	1	SC
		Bore for			
(3)	911 503 032 03	Direction indicator light Wing	/R 81-	1	SC
(3)	911 503 032 04	Wing	/R 81-	1	
3	930 503 032 09	Wing with	/R -80	1	TURBO
		POS.(2) with	81-		
		Bore for			
(3)	930 503 032 08	Direction indicator light Wing with	/R 81-	1	TURBO
		POS.(2)			
4	000 043 129 00	Sealing strap 25 X 2 MM		*	
5	901 503 394 22	Piping		2	
6	900 187 010 02	Hexagon-head tapping screw BZ 6,3 X 19		32	
6	900 187 010 03	Hexagon-head tapping screw BZ 6,3 X 19		32	
7	N 010 217 9	Hexagon-head bolt M 6 X 20		4	
(7)	900 067 011 02	Pan-head screw		4	
(7)	900 067 011 03	Pan-head screw		4	

Model: 911 78 Model life 1978>>1983

Pos	Part Number	Description	Remark	Qty	Model
(7)	900 067 011 02	Pan-head screw M 6 X 20		4	
(7)	900 067 011 03	Pan-head screw M 6 X 20		4	
8	N 011 666 7	Washer B 6,4		32	
9	N 011 550 1	Washer		4	
9		Washer B 6,5		4	
10	999 704 157 40	Washer		32	
11	999 591 327 02	Speed nut B 6,3		32	
11	999 501 327 01	Speed nut B 6,3		32	
11	999 591 327 01	Speed nut B 6,3		32	
12	911 504 031 00	Lid		1	
12		Lid		1	
		Tank filler neck			
	911 504 031 00 GRV	Prime coated			
13	911 504 331 00	Spring		1	
13		Spring		1	
14	900 067 051 02	Pan-head screw M 5 X 10		3	
15	N 012 005 3	Lock ring		3	
15		Lock ring B 5		3	
16	900 025 003 02	Washer 5,3		3	
17	901 504 317 21	Lid-release cable with Threaded piece		1	
18	911 504 385 00	Rubber washer		1	
19	901 552 822 00	Knob		1	
20	901 504 385 20	Connecting tube		1	
21	999 702 020 50	Rubber sleeve		1	
22	914 504 319 00	Grommet		1	
23	999 230 002 02	Screw nipple		1	
24	901 504 034 20	Bearing		1	
24		Bearing		1	
	901 504 034 20 GRV	Prime coated			
25	911 025 679 00	Buffer		1	
26	911 503 015 00	Headlamp casing	/L	1	
(26)	911 503 016 00	Headlamp casing	/R	1	
27	911 503 079 00	Wing strut	/L	1	
27	911 503 079 01	Wing strut	/L	1	
27		Wing strut	/L	1	
	911 503 079 01 GRV	Prime coated			
(27)	911 503 080 00	Bracket	/R	1	
(27)	911 504 080 00	Bracket	/R	1	
	911 504 080 00 GRV	Prime coated			
		When required order also:			
-	911 635 107 00	Support		1	
-	900 076 010 0B	Nut		2	
-	N 042 121 3	Shake-proof washer		2	
-	N 011 525 13	Washer		1	
-	900 076 064 02	Hexagon nut		1	
28	900 075 087 02	Hexagon-head bolt M 8 X 16		4	
28	900 075 087 03	Hexagon-head bolt M 8 X 16		4	
29	900 027 015 02	Lock ring		4	
29	900 027 015 03	Lock ring		4	

Model: 911 78

Model life 1978>>1983

Pos	Part Number	Description	Remark	Qty	Model
29	900 027 015 02	Lock ring B 8		4	
29	900 027 015 03	Lock ring B 8		4	
30	900 025 007 02	Washer		4	
30	900 025 007 03	Washer		4	
31	911 503 401 04	Door sill	/L	1	
31	911 503 401 05	Door sill	/L	1	
	911 503 401 05 GRV	Prime coated			
31	911 503 401 05	Door sill	/L	1	
	911 503 401 05 GRV	Prime coated			
(31)	911 503 402 04	Door sill	/R	1	
32	411 837 111	Cap		4	

Model: 911 78

Model life 1978>>1983

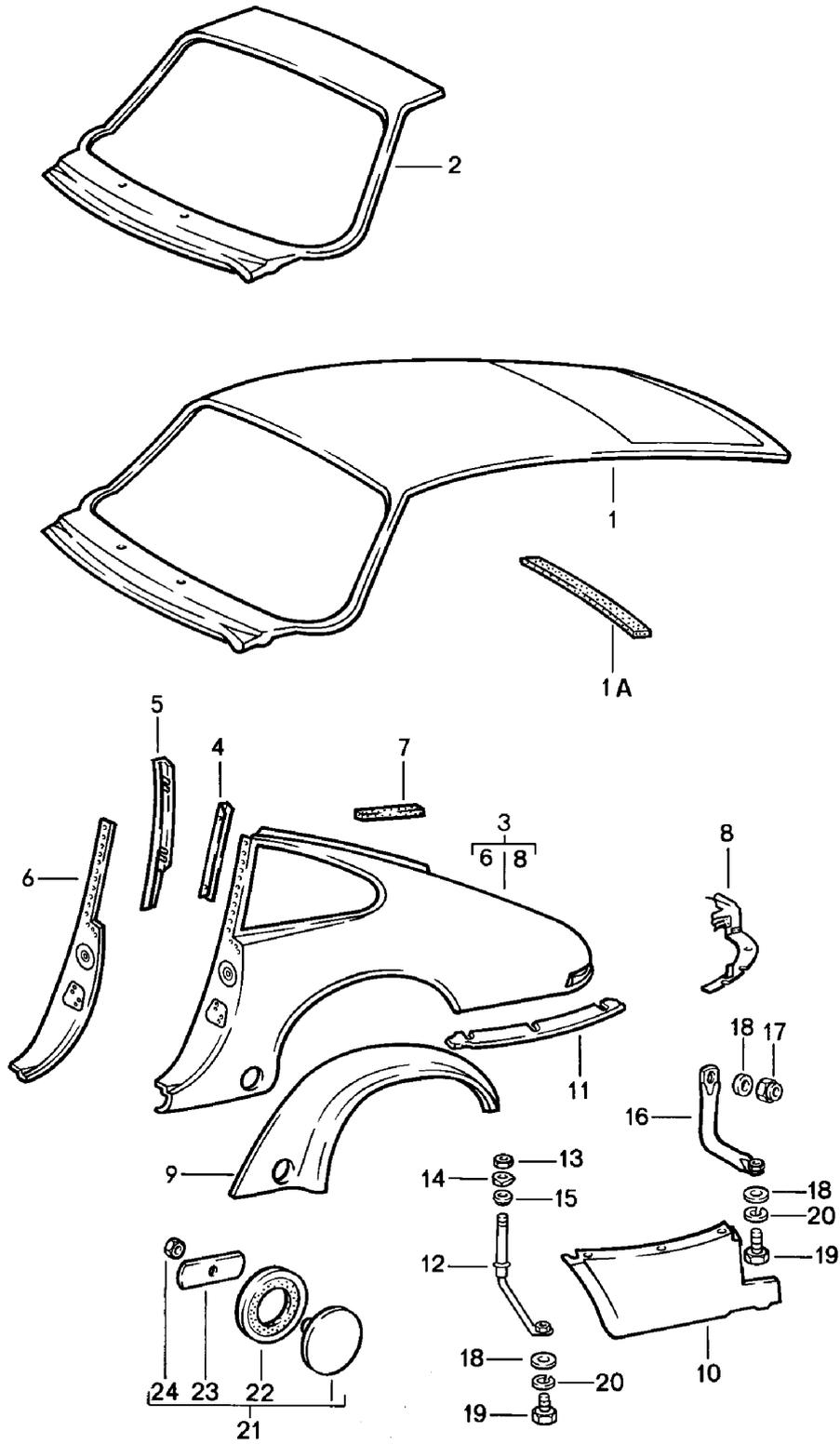

Model: 911 78 Model life 1978>>1983

Pos	Part Number	Description	Remark	Qty	Model
		Exterior panelling Rear			
1	911 503 087 04	It is necessary to rework Outer roof panel		1	COUPE
1	911 503 087 08	Outer roof panel		1	COUPE
		Order also:			
-	928 628 077 00	Nozzle		2	
(1)	911 503 087 05	Outer roof panel		1	M650
(1)	911 503 087 09	Outer roof panel		1	M650
		Order also:			
-	928 628 077 00	Nozzle		2	
1A	911 503 507 01	Plastic foam strip Bleeding		1	COUPE
2	901 503 090 21	Windscreen frame part		1	COUPE
2	911 503 987 00	Windscreen frame part		1	COUPE
2	911 503 987 01	Windscreen frame part		1	COUPE
		Order also:			
2		Windscreen frame part		1	COUPE
		Order also:			
-	911 503 987 01 GRV	Prime coated			
-	928 628 077 00	Nozzle		2	
3	911 503 061 06	Wing	/L	1	COUPE
3	911 503 061 10	Side section	/L	1	COUPE
3		Side section	/L	1	COUPE
		It is necessary to rework			
	911 503 061 10 GRV	Prime coated			
-	911 504 471 00	Cap Behind	/L	1	
(3)	930 503 061 00	Lock pillar Wing with POS.9	/L	1	TURBO
		It is necessary to rework			
-	911 504 471 00	Cap Behind	/L	1	
(3)	911 503 062 06	Lock pillar Wing	/R	1	COUPE
(3)	911 503 062 10	Side section	/R	1	COUPE
(3)		Side section	/R	1	COUPE
	911 503 062 10 GRV	Prime coated			
(3)	930 503 062 00	Wing	/R	1	TURBO
(3)	930 503 062 01	Side section with POS.9	/R	1	TURBO
(3)		Side section with POS.9	/R	1	TURBO
	930 503 062 01 GRV	Prime coated			
4	911 503 193 00	Retaining strip Sealing frame		2	COUPE
5	911 502 043 02	Lock pillar Inner panel	/L	1	
(5)	911 502 044 02	Lock pillar Inner panel	/R	1	
6	911 502 041 02	Lock pillar	/L	1	
6	911 502 041 03	Lock pillar	/L	1	
(6)	911 502 042 02	Lock pillar	/R	1	
(6)	911 502 042 03	Lock pillar	/R	1	
7	911 504 933 00	Seal	/L	1	
(7)	911 504 934 00	Wheel housing Seal	/R	1	
8	911 503 073 00	Wheel housing Bar	/L	1	

Model: 911 78

Model life 1978>>1983

Pos	Part Number	Description	Remark	Qty	Model
8	911 503 073 00 GRV	Combined lights Bar Prime coated	/L	1	
(8)	911 503 074 00	Combined lights Bar	/R	1	
(8)	911 503 074 00 GRV	Combined lights Bar Prime coated	/R	1	
9	930 503 607 00	Wing joining plate	/L	1	TURBO
9	930 503 607 00 GRV	Wing joining plate Prime coated	/L	1	TURBO
(9)	930 503 608 00	Wing joining plate	/R	1	TURBO
(9)	930 503 608 00 GRV	Wing joining plate Prime coated	/R	1	TURBO
10	911 503 067 03	Lower part	/L	1	SC
10	911 503 067 03 GRV	Lower part Prime coated	/L	1	SC
(10)	930 503 067 00	Side section	/L	1	TURBO
(10)	930 503 067 00 GRV	Lower part Side section Prime coated	/L	1	TURBO
(10)	911 503 068 03	Lower part	/R	1	SC
(10)	911 503 068 03 GRV	Lower part Prime coated	/R	1	SC
(10)	930 503 068 00	Lower part Side section	/R	1	TURBO
(10)	930 503 068 00 GRV	Lower part Prime coated	/R	1	TURBO
(10)	930 503 068 01	Side section	/R	1	TURBO
(10)	930 503 068 01 GRV	Side section Prime coated Lower part	/R	1	TURBO
11	911 503 185 01	Intermediate layer	/L	1	SC
(11)	911 503 186 01	Intermediate layer	/R	1	SC
-	PCG 799 503 07	Set Piping Body Front and rear Comprising:	76-89	1	
-	911 503 185 01	Intermediate layer		1	
-	911 503 186 01	Intermediate layer		1	
-	911 503 325 00	Intermediate layer		2	
-	911 503 326 00	Intermediate layer		2	
-	911 559 511 00	Gasket		2	
-	911 799 503 07	Wing seal		2	
(11)	000 043 204 81	Intermediate layer		*	TURBO
12	911 501 623 02	Support tube	/V	2	
(12)	911 501 623 02	Support tube	/V	2	
13	900 078 009 02	Hexagon nut M 20 X 1,5		2	
14	900 025 021 02	Washer		2	
15	901 501 913 21	Sealing ring		2	
16	911 501 628 01	Support tube	/H	2	
(16)	911 501 628 01	Support tube	/H	2	
17	900 084 003 02	Lock nut		2	
17	900 910 012 02	Lock nut M 6		2	
17	900 910 047 09	Lock nut M 6		2	
18	900 151 006 09	Washer		6	

Model: 911 78

Model life 1978>>1983

Pos	Part Number	Description	Remark	Qty	Model
18	N 011 666 7	Washer 6,4		6	
19	900 074 221 02	Hexagon-head bolt		4	
19	999 072 005 09	Hexagon nut M 6 X 12		4	
19	999 072 005 01	Hexagon nut M 6 X 12		4	
20	N 012 007 2	Lock ring A 6		4	
20	900 027 004 03	Lock ring A 6		4	
21	901 504 079 00	Spring cover		2	
22	901 504 759 01	Desk pad		2	
23	901 504 755 20	Tensioning spring		2	
24	900 076 027 02	Nut		2	
24	N 011 005 14	Hexagon nut M 5		2	
24	900 076 091 01	Hexagon nut M 5		2	

Model: 911 78

Model life 1978>>1983

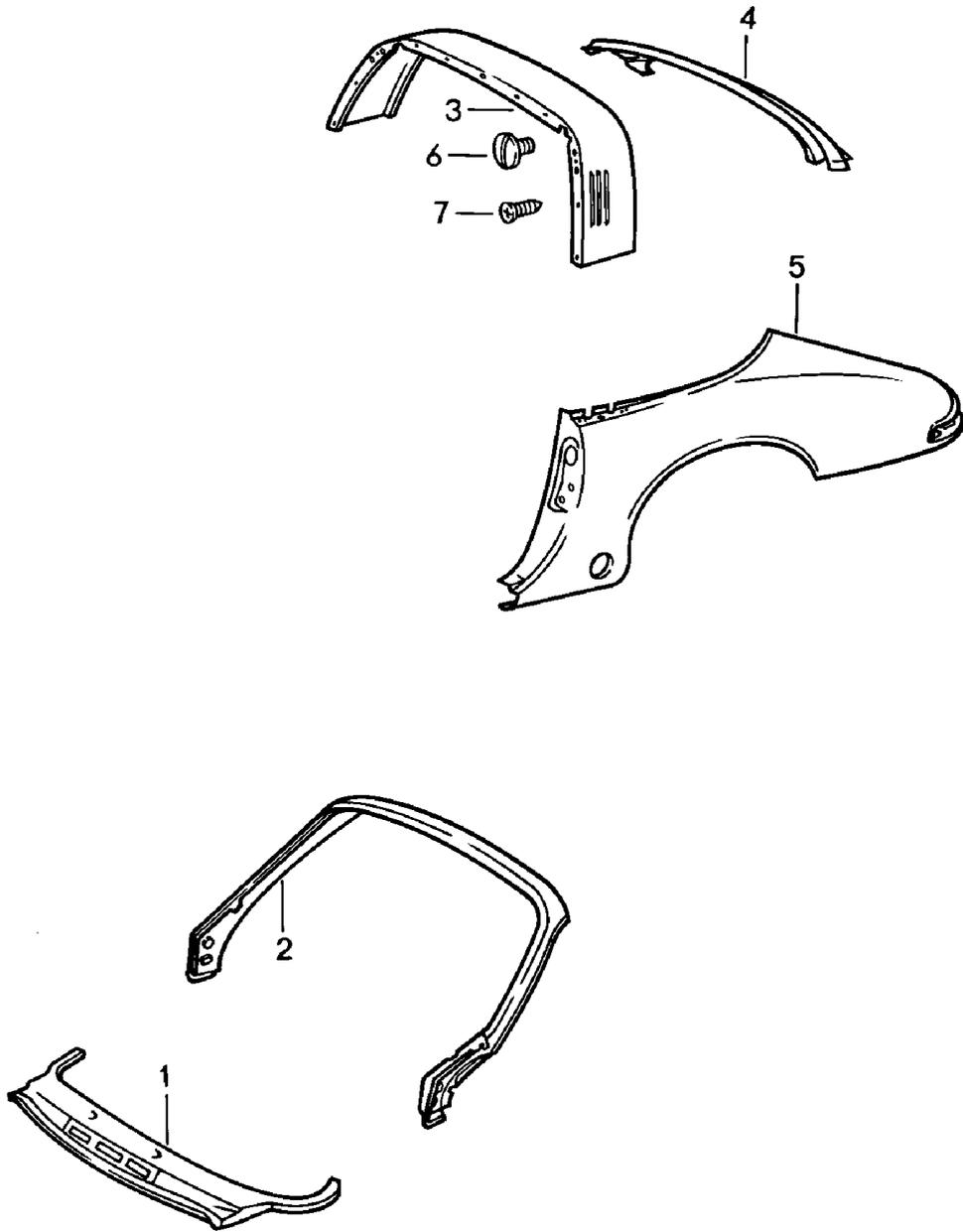

Model: 911 78 Model life 1978>>1983

Pos	Part Number	Description	Remark	Qty	Model
		Exterior panelling			TARGA/CABRIO
		It is necessary to rework			
1	911 503 087 40	Scuttle		1	
2	911 599 503 32	Windscreen frame		1	
3	911 565 043 48	Lining		1	TARGA
4	901 503 322 40	Rear end		1	
5	911 503 061 46	Wing	/L	1	TARGA
5	911 503 061 50	Side section	/L	1	TARGA
5	911 503 061 50 GRV	Side section	/L	1	TARGA
	911 503 061 50 GRV	Prime coated			
(5)	911 503 061 60	Side section	/L	1	CABRIO
(5)	911 503 061 61	Side section	/L	1	CABRIO
(5)	911 503 061 61 GRV	Side section	/L	1	CABRIO
	911 503 061 61 GRV	Prime coated			
(5)	911 503 062 50	Side section	/R	1	TARGA
(5)	911 503 062 50 GRV	Side section	/R	1	TARGA
	911 503 062 50 GRV	Prime coated			
(5)	911 503 062 60	Side section	/R	1	CABRIO
(5)	911 503 062 61	Side section	/R	1	CABRIO
	911 503 062 61 GRV	Prime coated			
6	901 801 153 40	Screw plug		4	TARGA
		Ski rack			
6	999 064 037 40	Screw plug		4	TARGA
		Ski rack			
7	N 013 957 5	Oval-head sheetmetal screw		15	TARGA
		B 3,5 X 9,5			

Model: 911 78

Model life 1978>>1983

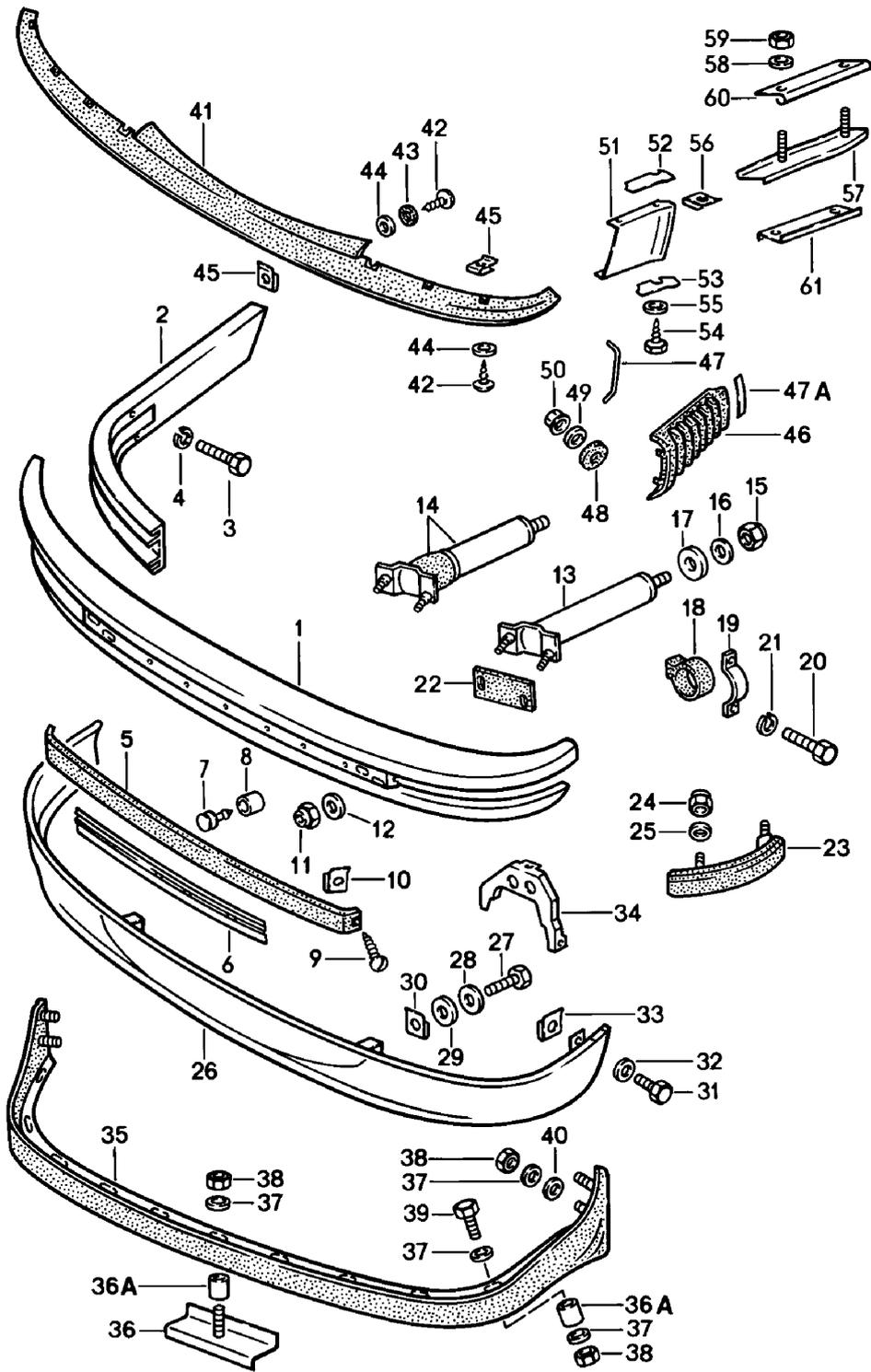

Model: 911 78

Model life 1978>>1983

Pos	Part Number	Description	Remark	Qty	Model
1	911 505 011 10	Bumper	/V	1	
(1)	911 505 011 13	Bumper	-81	1	M288
(1)	930 505 011 02	Bumper	-81	1	
5	911 505 147 03	Bumper	82-	1	
5	911 505 147 03	Protective moulding		1	
5	911 505 147 04	Protective moulding		1	
-	PCG 505 147 03	Set of fastening parts		1	
		Protective moulding			
		Comprising:			
-	900 143 085 07	Tapping screw		2	
-	911 505 417 00	Moulding plug		7	
-	999 507 018 01	Speed nut		2	
6	911 505 149 02	Insert		1	
7	911 505 417 00	Moulding plug		7	
8	911 505 418 00	Grommet		7	
9	900 143 113 07	Oval-head screw	-81	2	
		B 4,2 X 13			
9	900 143 113 0G	Oval-head screw		2	
		B 4,2 X 13			
9	900 143 085 07	Tapping screw	83-	2	
		B 4,2 X 16			
10	999 507 018 02	Speed nut		2	
10	999 507 018 01	Speed nut		2	
11	N 011 185 6	Hexagon nut		4	
		M 10			
12	900 025 008 09	Washer		4	
		10,5			
12	900 025 008 04	Washer		4	
		10,5			
13	911 505 045 03	Impact pipe		2	
14	911 505 279 03	Impact absorber		2	
15	900 084 004 03	Hexagon nut		2	
		M 8			
15	900 084 004 02	Hexagon nut		2	
		M 8			
(15)	999 084 608 02	Hexagon nut		2	M058
		M 12			
16	900 151 008 02	Washer		2	
16		Washer		2	
		A 8,4			
(16)	900 025 009 02	Washer		2	M058
		13			
17	911 505 220 01	Desk pad		2	
(17)	911 505 219 01	Desk pad		2	M058
18	911 505 221 00	Stop		2	
19	911 505 223 00	Supporting bow		2	
20	999 093 010 02	Hexagon-head bolt		4	
		M 8 X 20			
21	N 012 009 3	Lock ring		4	
21	900 027 015 02	Lock ring		4	
		A 8			
21	900 027 015 03	Lock ring		4	
		A 8			
22	911 505 311 00	Desk pad		2	
23	911 505 307 00	Cover	/L	1	
(23)	911 505 308 00	Cover	/R	1	
24	N 021 196 1	Lock nut		4	
24	N 021 196 3	Hexagon nut		4	
24	N 021 196 1	Lock nut		4	
		M 5			
24	N 021 196 3	Hexagon nut		4	
		M 5			
25	900 151 027 02	Washer		4	

Model: 911 78 Model life 1978>>1983

Pos	Part Number	Description	Remark	Qty	Model
25	900 151 027 03	Washer		4	
25	N 011 665 3	Washer A 5,3		4	
25	N 011 665 16	Washer A 5,3		4	
26	911 503 049 00	Front apron		1	SC
(26)	930 503 049 00	Front apron		1	TURBO
(26)	930 503 049 00 GRV	Front apron Prime coated		1	TURBO
27	900 187 010 02	Hexagon-head tapping screw BZ 6,3 X 19		2	
27	900 187 010 03	Hexagon-head tapping screw BZ 6,3 X 19		2	
28	900 151 006 09	Washer		2	
28	N 011 666 7	Washer B 6,4		2	
29	999 704 157 40	Washer		2	
30	999 591 327 02	Speed nut B 6,3		2	
30	999 501 327 01	Speed nut B 6,3		2	
30	999 591 327 01	Speed nut B 6,3		2	
31	900 187 010 02	Hexagon-head tapping screw BZ 6,3 X 19		2	
31	900 187 010 03	Hexagon-head tapping screw BZ 6,3 X 19		2	
32	N 011 666 7	Washer B 6,4		2	
33	999 591 327 02	Speed nut B 6,3		2	
33	999 501 327 01	Speed nut B 6,3		2	
33	999 591 327 01	Speed nut B 6,3		2	
34	911 503 079 01	Wing strut	/L	1	
34	911 503 079 01 GRV	Wing strut Prime coated	/L	1	
(34)	911 503 080 00	Bracket	/R	1	
(34)	911 504 080 00	Bracket	/R	1	
	911 504 080 00 GRV	Bracket Prime coated			
		When required order also:			
-	911 635 107 00	Support		1	
-	N 042 121 3	Shake-proof washer		2	
-	900 076 010 0B	Nut		2	
-	N 011 525 13	Washer		1	
-	900 076 064 02	Hexagon nut		1	
35	911 503 055 00	Front spoiler		1	SC
(35)	930 503 055 01	Front spoiler		1	TURBO
36	911 503 023 00	Shim		7	
36A	911 503 349 00	Spacer sleeve		11	
37	N 011 666 7	Washer B 6,4		11	
38	900 084 010 02	Lock nut		11	
38	900 910 012 02	Lock nut M 6		11	
38	900 910 047 09	Lock nut M 6		11	
39	N 010 217 9	Hexagon-head bolt M 6 X 20		4	
40	901 565 448 40	Spacer		4	
41	911 505 187 01	Sealing strip		1	
42	N 013 968 7	Tapping screw		12	

Model: 911 78 Model life 1978>>1983

Pos	Part Number	Description	Remark	Qty	Model
42	900 143 097 01	B 4,8 X 13 Tapping screw		12	
43	901 503 399 02	B 4,8 X 13 Rubber washer		4	
44	900 151 027 02	Washer		12	
44	900 151 027 03	Washer		12	
44	N 011 665 3	Washer		12	
44	N 011 665 16	A 5,3 Washer		12	
45	999 507 041 09	A 5,3 Speed nut		12	
45		Speed nut		12	
46	911 799 505 63	B 4,8 Bellows	/L	1	
46	911 799 505 13	Bellows	/L	1	
(46)	911 799 505 64	Bellows	/R	1	
(46)	911 799 505 14	Bellows	/R	1	
47	911 505 375 00	Clamp		2	
47A	930 503 329 00	Desk pad	/L	1	TURBO
(47A)	930 503 330 00	Desk pad	/R	1	TURBO
48	901 511 791 21	Rubber washer		8	
49	900 025 003 02	Washer		8	
50	900 910 009 02	A 5,3 Lock nut		8	
50	900 084 026 01	NM 5 Lock nut		8	
51	911 503 315 00	NM 5 Front apron	/L	1	SC
51		Front apron	/L	1	SC
(51)	911 503 315 00 GRV	Prime coated			
(51)	911 503 316 00	Front apron	/R	1	SC
(51)		Front apron	/R	1	SC
52	911 503 316 00 GRV	Prime coated			
52	911 503 326 00	Intermediate layer		2	SC
53	911 503 325 00	Upper Intermediate layer		2	SC
-	PCG 799 503 07	Lower Set	75-89	1	
-		Piping			
-		Body			
-		Front and rear			
-		Comprising:			
-	911 503 185 01	Intermediate layer		1	
-	911 503 186 01	Intermediate layer		1	
-	911 503 325 00	Intermediate layer		2	
-	911 503 326 00	Intermediate layer		2	
-	911 799 503 07	Wing seal		2	
-	911 559 511 00	Gasket		2	
-	PCG 503 394 00	Set	75-89	1	TURBO
-		Piping			
-		Body			
-		Front and rear			
-		Comprising:			
-	930 503 197 00	Piping		2	
-	911 503 325 00	Intermediate layer		2	
-	911 503 326 00	Intermediate layer		2	
-	901 503 394 22	Piping		2	
54	900 187 004 02	Hexagon-head tapping screw		8	
54		Hexagon-head tapping screw		8	
55	N 011 665 3	B 4,8 X 19 Washer		8	
55	N 011 665 16	A 5,3 Washer		8	

Model: 911 78 Model life 1978>>1983

Pos	Part Number	Description	Remark	Qty	Model
56	999 507 041 09	A 5,3 Speed nut		8	
57	930 503 131 00	B 4,8 Plate with screw bolt	/L	1	TURBO
(57)	930 503 132 00	Plate with screw bolt	/R	1	TURBO
58	N 011 665 3	Washer B 5,3		4	
58	N 011 665 16	Washer B 5,3		4	
59	N 011 005 14	Hexagon nut M 5		4	
59	900 076 091 01	Hexagon nut		4	
60	930 503 197 00	Piping		2	
60		Piping		2	
-	PCG 503 394 00	Set Piping Body Front and rear Comprising:	75-89	1	TURBO
-	930 503 197 00	Piping		2	
-	911 503 325 00	Intermediate layer		2	
-	911 503 326 00	Intermediate layer		2	
-	901 503 394 22	Piping		2	
61	930 503 327 01	Plate with pressed-in hole Number plate Mount		2	
-	911 701 057 00	Set of fastening parts Number plate Front and rear Comprising:		1	
-	911 701 201 00	Support		1	
-	999 591 354 02	Prestole cage		2	
-	803 955 637	Sealing washer		2	
-	N 011 524 7	Washer A 6,4		2	
-	N 011 524 27	Washer A 6,4		2	
-	900 187 115 02	Combination screw B 5,5 X 16		2	
-	900 187 115 01	Combination screw B 5,5 X 16		2	
-	999 591 498 40	Special nut		2	
-	N 011 522 8	Washer A 4,3		2	
-	900 143 134 00	Tapping screw BZ 4,2 X 9,5		2	
-	N 100 818 01	Oval-head screw CM 5 X 16		2	
-	900 025 003 02	Washer A 5,3		2	
-	914 571 903 10	Sealing ring		2	
-	911 701 057 01	Set of fastening parts Number plate Front and rear		1	
-	911 701 057 02	(USA)(CDN)(J)(AUS)(A) Set of fastening parts Number plate Front and rear (B)(I)		1	

Model: 911 78

Model life 1978>>1983

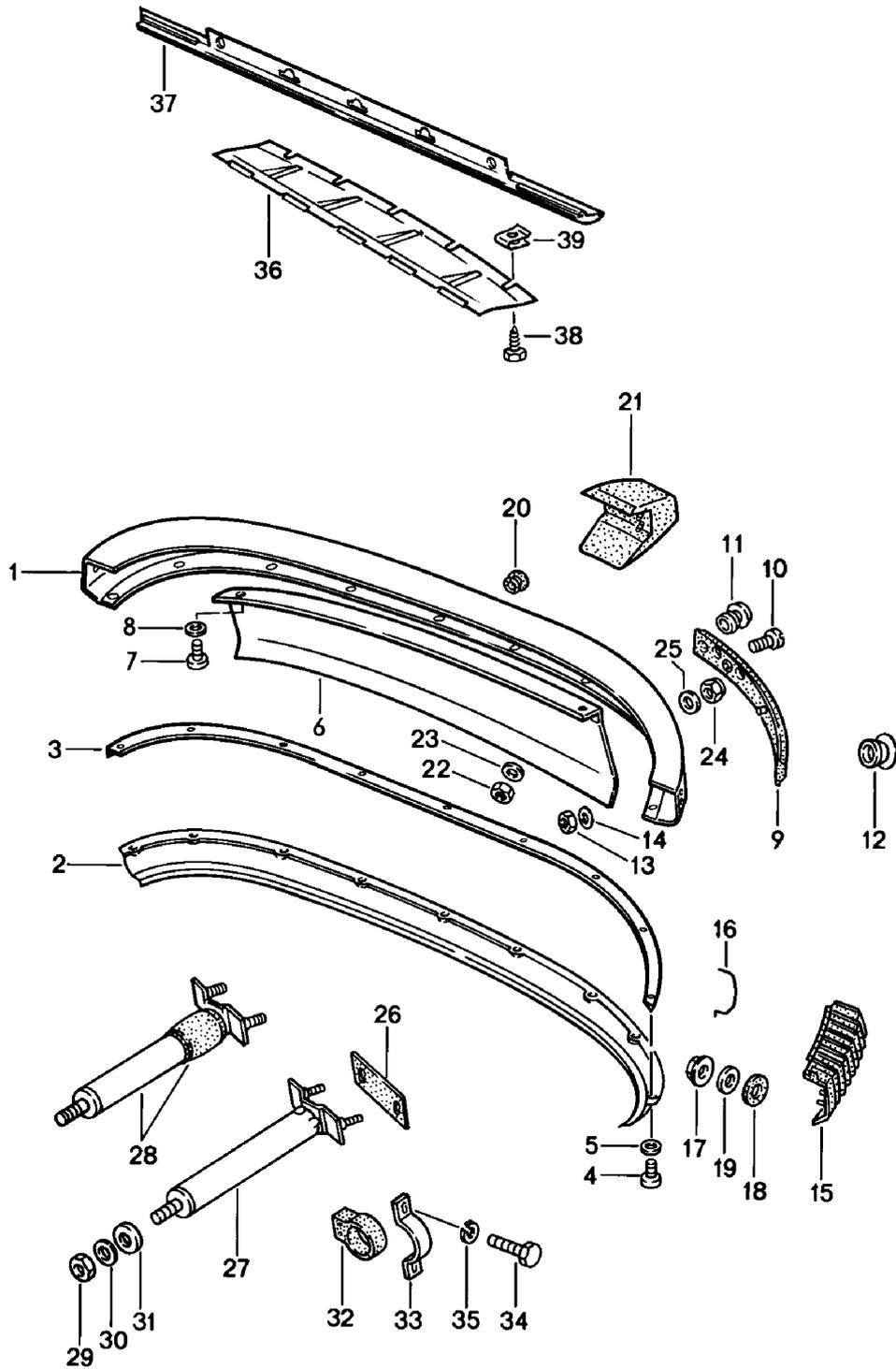

Model: 911 78 Model life 1978>>1983

Pos	Part Number	Description	Remark	Qty	Model
1	911 505 167 10	Bumper	/H	1	SC
(1)	930 505 012 05	Bumper	-82	1	SC
(1)	930 505 012 00	Bumper	83	1	TURBO
(1)	930 505 012 05	Bumper	-82	1	TURBO
(1)	930 505 012 05	Bumper	83-	1	TURBO
2	911 505 171 01	Rear apron		1	SC
2	911 505 171 08	Rear apron		1	SC
2	911 505 171 08 GRV	Rear apron		1	SC
(2)	930 505 077 00	Prime coated		1	TURBO
(2)	930 505 077 04	Rear apron		1	TURBO
(2)	930 505 077 04 GRV	Rear apron		1	TURBO
(3)	911 505 345 03	Prime coated		1	
(3)	911 505 345 03	Piping		1	
(3)	911 505 345 03	Piping		1	
4	900 278 024 09	Screw		8	
		M 6 X 10			
5	N 011 524 7	Washer		8	
		A 6,4			
5	N 011 524 27	Washer		8	
		A 6,4			
6	930 505 511 00	Heat protection		1	TURBO
6	930 505 511 00 GRV	Heat protection		1	TURBO
(6)	930 505 511 02	Heat protection		1	TURBO
7	900 278 024 09	Screw		3	TURBO
		M 6 X 10			
8	N 011 524 7	Washer		6	TURBO
		A 6,4			
8	N 011 524 27	Washer		6	TURBO
		A 6,4			
9	911 505 099 01	Protective moulding	/L -82	1	SC
9	911 505 099 01 70A	Protective moulding	/L	1	SC
(9)	911 505 099 04	Black		1	SC
(9)	911 505 099 04	Protective moulding	/L 83-	1	SC
(9)	911 505 100 01	Protective moulding	/R	1	SC
(9)	930 505 089 00	Protective moulding	/L	1	TURBO
(9)	930 505 090 00	Protective moulding	/R	1	TURBO
	930 505 090 00 70A	Black		1	
10	999 141 001 02	Half-round screw		2	
		M 5 X 12			
10	999 141 001 0B	Half-round screw		2	
		M 5 X 12			
11	911 505 327 00	Stopper		1	
(11)	999 703 181 40	Stopper	83-	1	
12	914 552 233 10	Filler piece		2	
	914 552 233 10 01C	Black		2	
12	914 552 233 10	Filler piece		2	
	914 552 233 10 01C	Black		2	
13	900 910 011 02	Lock nut		3	TURBO
		M 6			
14	900 151 003 02	Washer		3	TURBO
		A 6,4			
14	900 151 006 03	Washer		3	TURBO
		A 6,4			
(14)	999 704 135 70	Washer		3	TURBO
		7 X 17 X 1,5 MONTANIT			
15	911 799 505 65	Bellows	/L	1	
15	911 799 505 15	Bellows	/L	1	
(15)	911 799 505 66	Bellows	/R	1	
(15)	911 799 505 16	Bellows	/R	1	
16	911 505 376 00	Clamp		2	
17	900 910 009 02	Lock nut		8	

Model: 911 78 Model life 1978>>1983

Pos	Part Number	Description	Remark	Qty	Model
17	900 084 026 01	NM 5 Lock nut		8	
18	901 511 791 21	NM 5 Rubber washer		8	
19	900 025 003 02	Washer A 5,3		8	
20	911 505 347 00	Rubber sleeve		2	
21	911 505 341 00	Buffer	/L	1	SC
(21)	930 505 031 00	Buffer	/L	1	TURBO
(21)	911 505 342 00	Buffer	/R	1	SC
(21)	930 505 032 00	Buffer	/R	1	TURBO
22	900 084 004 03	Hexagon nut M 8		4	
22	900 084 004 02	Hexagon nut M 8		4	
22	900 084 004 03	Hexagon nut M 8		4	
22	900 084 004 02	Hexagon nut M 8		4	
23	900 025 007 02	Washer 8,4		4	
23	900 025 007 03	Washer 8,4		4	
24	N 011 185 6	Hexagon nut M 10		4	
25	900 025 008 09	Washer		4	
25	900 025 008 04	Washer		4	
25	900 025 008 09	Washer 10,5		4	
25	900 025 008 04	Washer 10,5		4	
26	911 505 311 00	Desk pad		2	
27	911 505 046 03	Impact pipe		2	
28	911 505 280 03	Impact absorber		2	
29	999 084 608 02	Hexagon nut M 12		2	
30	900 025 009 02	Washer 13		2	
31	911 505 220 01	Desk pad		2	
(31)	911 505 219 01	Desk pad		2	M058
32	911 505 221 00	Stop		2	
33	911 505 223 00	Supporting bow		2	
34	999 093 010 02	Hexagon-head bolt M 8 X 20		4	
35	N 012 009 3	Lock ring		4	
35	900 027 015 02	Lock ring A 8		4	
35	900 027 015 03	Lock ring A 8		4	
36	911 503 157 01	Heat protection		1	SC
36		Heat protection		1	SC
(36)	930 503 157 01	Heat protection		1	TURBO
(36)		Heat protection		1	TURBO
37	911 503 085 05	Seal		1	
38	N 013 970 5	Oval-head sheetmetal screw B 4,8 X 9,5		5	
38	N 106 568 02	Oval-head sheetmetal screw B 4,8 X 9,5		5	
39	999 507 041 09	Speed nut B 4,8		5	

Model: 911 78

Model life 1978>>1983

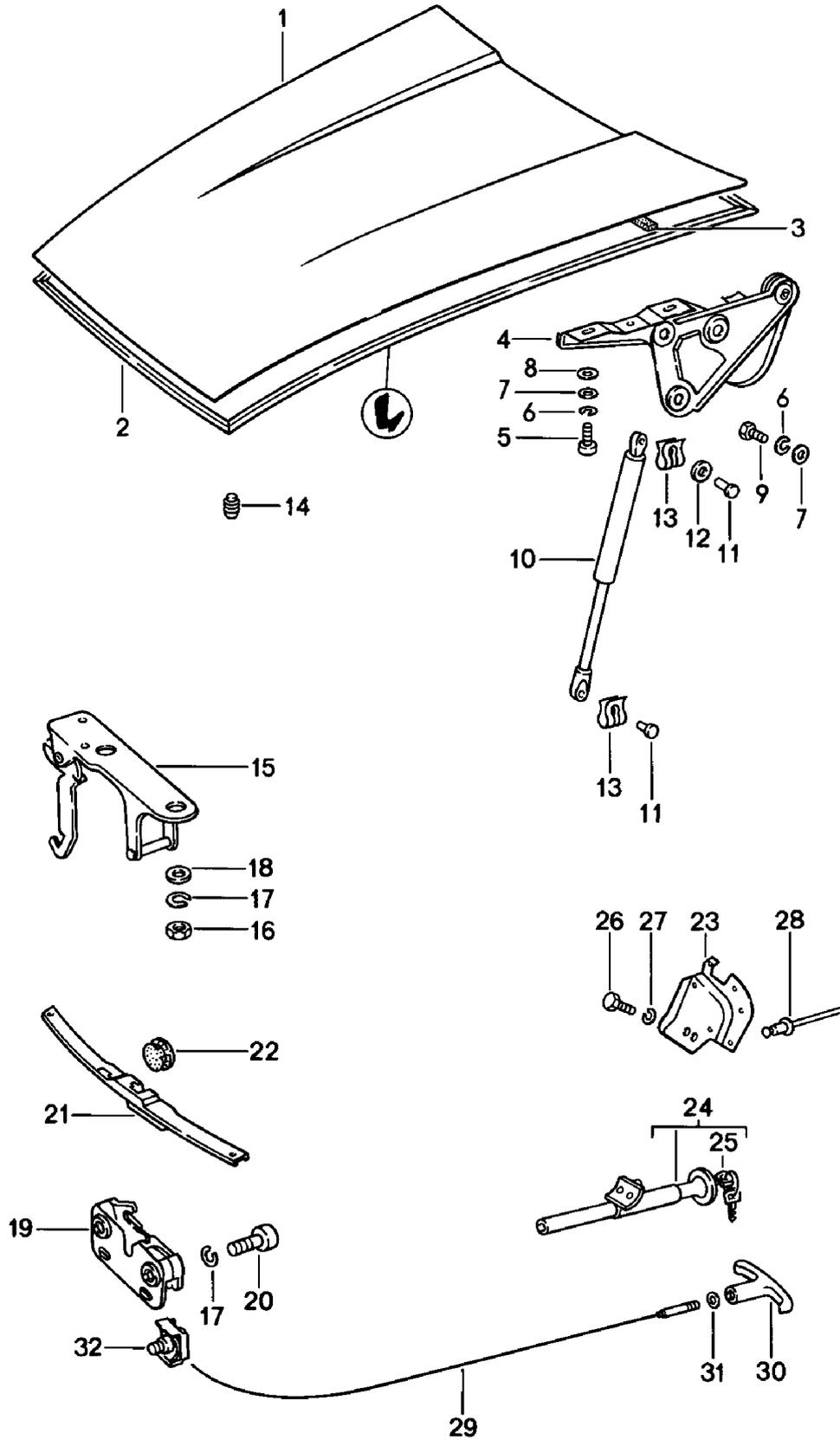

Model: 911 78

Model life 1978>>1983

Pos	Part Number	Description	Remark	Qty	Model
		Lid	/V		
1	911 511 010 01	Lid		1	
1	911 511 010 03	Lid		1	
	911 511 010 03 GRV	Prime coated			
		Use also:			
-	997 632 201 00	Light		1	
2	911 511 923 02	Sealing frame		1	
3	911 511 127 00	Sealing frame		1	TARGA
		Protective strip			
		Targa			
		Soft top			
4	901 511 031 20	Hinge	/L	1	
4	911 511 031 00	Hinge	/L	1	
(4)	901 511 032 20	Hinge	/R	1	
(4)	911 511 032 00	Hinge	/R	1	
5	900 067 057 02	Pan-head screw		4	
		M 8 X 20			
5	900 067 057 03	Pan-head screw		4	
		M 8 X 20			
6	900 027 015 02	Lock ring		10	
		B 8			
6	900 027 015 03	Lock ring		10	
		B 8			
7	900 025 007 02	Washer		10	
		8,4			
7	900 025 007 03	Washer		10	
		8,4			
8	900 151 008 02	Washer		X	
		8,4			
9	900 075 085 02	Hexagon-head bolt		6	
		M 8 X 20			
10	911 511 331 01	Gas-pressure spring		2	
10	911 511 331 00	Gas-pressure spring		2	
10		Gas-pressure spring		2	
10		Gas-pressure spring		2	
11	999 166 043 02	Bolt		4	
12	911 511 332 00	Spacer		2	
13	N 012 645 2	Lock washer		4	
14	999 703 036 50	Rubber stop		2	
15	911 511 051 02	Lock upper part		1	
16	900 076 010 02	Nut		2	
		M 6			
16	900 076 010 0B	Nut		2	
		M 6			
17	N 012 007 2	Lock ring		4	
		A 6			
17	900 027 004 03	Lock ring		4	
		A 6			
18	N 011 666 7	Washer		2	
		B 6,4			
19	911 511 052 01	Lock lower part		1	
20	N 014 743 2	Pan-head screw		2	
		M 6 X 30			
20	900 067 012 03	Pan-head screw		2	
		M 6 X 30			
21	911 555 085 00	Cover		1	
		Cross panel			
22	999 703 119 40	Stopper		2	
23	911 511 725 43	Support		1	TARGA
		Lock			CABRIO
24	911 511 903 00	Lock		1	TARGA
		with 2 secondary keys			TARGA
		W/o stipulated lock number			CABRIO

Model: 911 78

Model life 1978>>1983

Pos	Part Number	Description	Remark	Qty	Model
24	911 511 904 00	Lock with 2 secondary keys with stipulated lock number		1	TARGA CABRIO
25		See group 8/04/00			
26	900 075 001 03	Hexagon-head bolt M 5 X 8		2	TARGA CABRIO
27	900 027 011 01	Lock ring A 5		2	TARGA CABRIO
28	999 190 123 02	Blind rivet 3,2 X 7,37		4	TARGA CABRIO
29	901 511 073 20	Lid-release cable		1	
29	901 511 073 21	Lid-release cable		1	
30	901 552 813 20	Handle		1	COUPE
31	901 511 791 21	Rubber washer		1	COUPE
32	911 511 067 00	Clamp		1	COUPE

Model: 911 78

Model life 1978>>1983

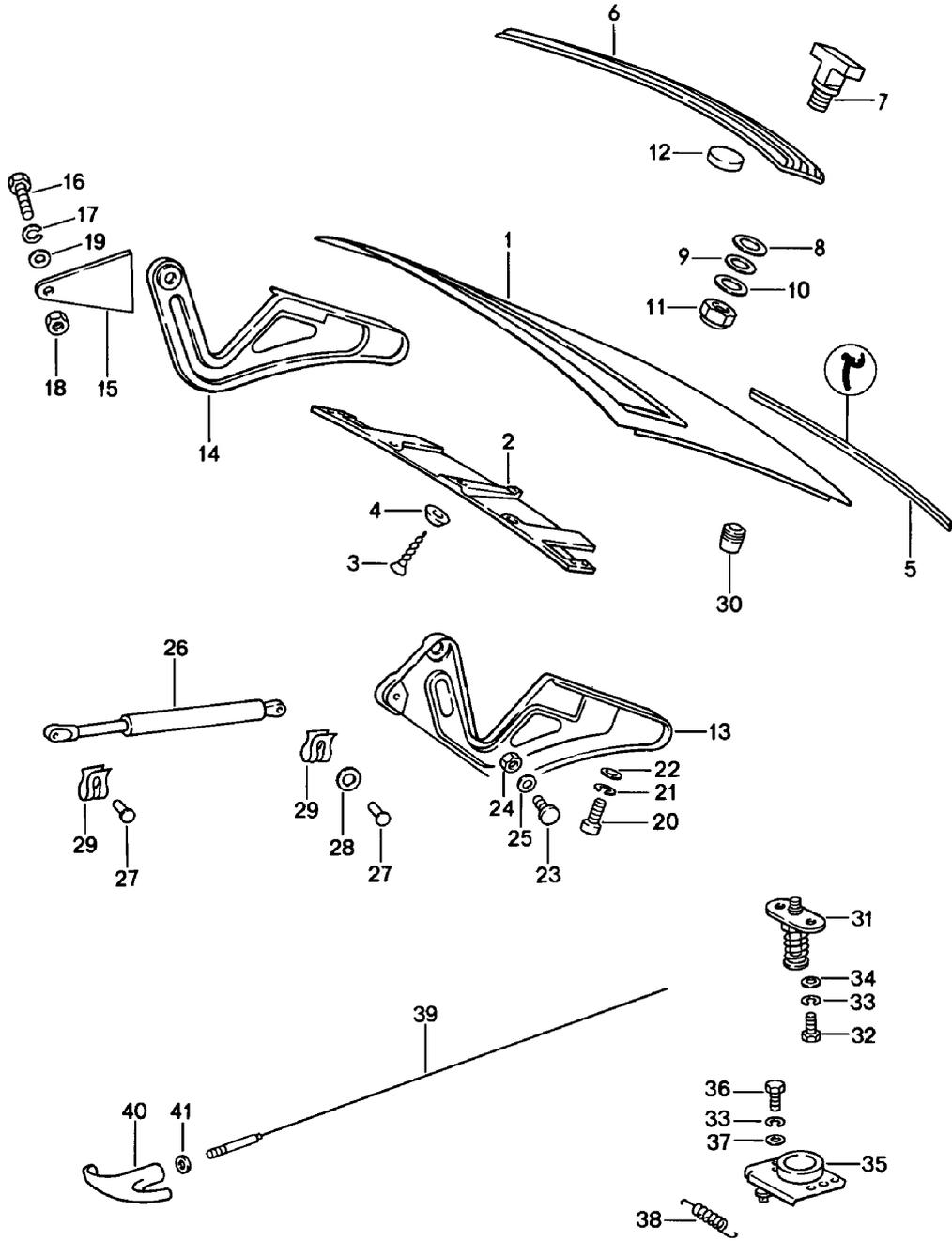

Model: 911 78 Model life 1978>>1983

Pos	Part Number	Description	Remark	Qty	Model
		Lid	/H		
1	911 512 010 56	Lid		1	SC
1	911 512 010 57	Lid	81-	1	M473
(1)	930 512 010 09	Lid		1	TURBO
2	911 512 109 01	Air guide	(D) -80	1	
(2)		Air guide	(D) -80	1	
3	N 013 958 7	Oval-head sheetmetal screw	(D) -80	4	
3		Oval-head sheetmetal screw	(D) -80	4	
		3,5 X 13			
4	900 151 001 02	Washer	(D) -80	4	
		4,3			
-	911 512 255 00	Intermediate layer	(D) -80	3	M399 M559
-	911 512 181 01	Mount	(D) -80	2	M399 M559
		Air guide			
-	999 143 003 02	Hexagon-head bolt	(D) -80	2	M399 M559
		M 5 X 10			
		Gasket		1	
5	911 512 129 00	Ventilation grille		1	
6	911 559 411 00	Ventilation grille		1	
6	911 559 411 01	Ventilation grille		1	
6	911 559 411 00	Ventilation grille		1	
6	911 559 411 01	Ventilation grille		1	
7	911 559 433 00	T-headed screw		6	
(7)	911 559 433 01	T-headed screw		2	M399/559
8	911 559 435 00	Spacer		6	
9	113 951 539	Washer		6	
10	N 011 665 3	Washer		6	
		B 5,3			
10	N 011 665 16	Washer		6	
		B 5,3			
11	900 910 009 02	Lock nut		6	
		NM 5			
11	900 084 026 01	Lock nut		6	
		NM 5			
(11)	900 034 006 02	Hexagon nut		2	M399/559
(11)		Hexagon nut		2	M399/559
		BM 5			
12	911 559 151 01	Base		6	
13	911 512 035 00	Hinge	/L	1	
14	901 512 036 20	Hinge	/R	1	
14		Hinge	/R	1	
	901 512 036 20 GRV	Prime coated			
(14)	930 512 036 00	Lid hinge		1	TURBO
(14)		Lid hinge		1	TURBO
	930 512 036 00 GRV	Prime coated			
15	930 512 039 00	Fastening plate		1	M473
16	900 075 016 02	Hexagon-head bolt		1	M473
16	900 075 016 03	Hexagon-head bolt		1	M473
16	900 075 016 02	Hexagon-head bolt		1	M473
		M 6 X 22			
16	900 075 016 03	Hexagon-head bolt		1	M473
		M 6 X 22			
17	N 012 226 5	Spring washer		1	M473
		B 6			
18	900 076 010 02	Nut		1	M473
		M 6			
18	900 076 010 0B	Nut		1	
		M 6			
19	N 011 524 7	Washer		1	M473
		6,4			
19	N 011 524 27	Washer		1	M473
		6,4			

Model: 911 78 Model life 1978>>1983

Pos	Part Number	Description	Remark	Qty	Model
20	900 067 011 02	Pan-head screw M 6 X 20		4	
20	900 067 011 03	Pan-head screw M 6 X 20		4	
21	N 012 006 4	Lock ring B 6		4	
22	N 011 666 7	Washer B 6,4		4	
23	901 512 471 20	Collar bolt		2	
24	900 910 023 02	Lock nut M 8		2	
(24)	999 084 052 02	Lock nut M 8		2	
25	900 025 007 02	Washer		2	
25	900 025 007 03	Washer		2	
25	900 025 007 02	Washer 8,4		2	
25	900 025 007 03	Washer 8,4		2	
26	911 512 331 01	Gas-pressure spring		1	SC
26		Gas-pressure spring		1	SC
(26)	911 512 331 02	Gas-pressure spring		2	M473/559
(26)		Gas-pressure spring		2	M473/559
27	999 166 043 02	Bolt		2	
27		Bolt		2	SC M473
28	911 511 332 00	Spacer		1	
29	N 012 645 2	Lock washer		2	
29		Lock washer		3	SC M473
29		Lock washer		3	
30	999 703 140 40	Rubber buffer		2	
31	930 512 052 00	Lock upper part		1	SC
(31)		Lock upper part		1	TURBO
32	900 075 162 02	Hexagon-head bolt M 6 X 16		2	SC
32	N 010 287 1	Hexagon-head bolt M 6 X 16		2	SC
32	900 075 057 02	Hexagon-head bolt M 6 X 16		2	SC
(32)	N 010 217 9	Hexagon-head bolt M 6 X 20		2	TURBO
33	N 012 006 4	Lock ring B 6		4	
34	N 011 666 7	Washer B 6,4		2	
35	901 512 052 00	Lock lower part		1	
36	900 075 162 02	Hexagon-head bolt M 6 X 16		2	
36	N 010 287 1	Hexagon-head bolt M 6 X 16		2	
36	900 075 057 02	Hexagon-head bolt M 6 X 16		2	
37	900 025 028 02	Washer		2	
37	N 011 666 7	Washer B 6,4		2	
38	644 511 511 01	Return spring		1	
39	901 511 073 20	Lid-release cable		1	
39	901 511 073 21	Lid-release cable		1	
40	901 552 813 20	Handle		1	
41	911 512 531 00	Grommet Lid-release cable		1	

Model: 911 78

Model life 1978>>1983

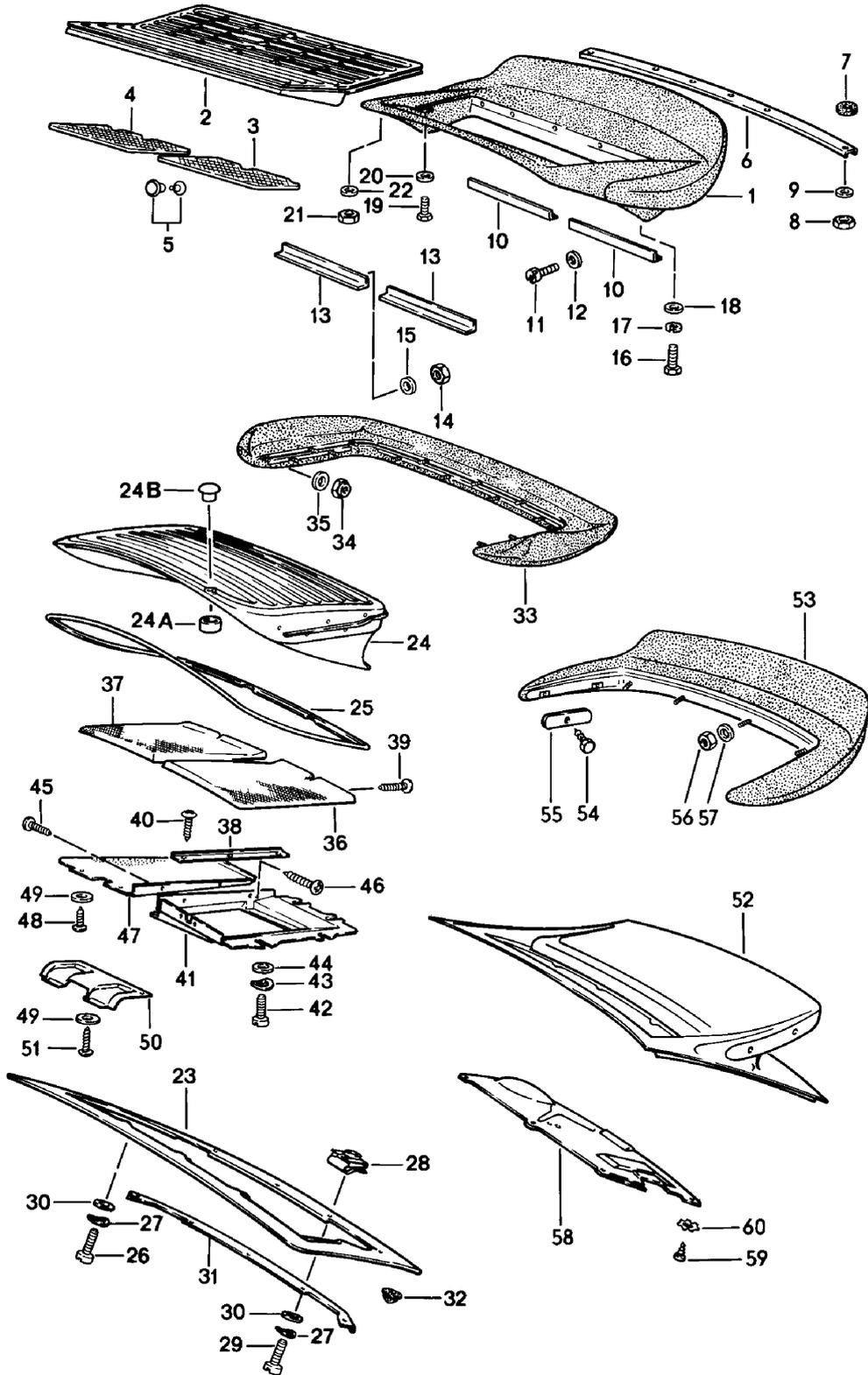

Model: 911 78

Model life 1978>>1983

Pos	Part Number	Description	Remark	Qty	Model
1	911 512 019 02	Rear spoiler Polyurethane rear spoiler	-80	1	M473
2	911 512 051 00	Ventilation grille	-80	1	M473
3	911 512 085 00	Grille	/L -80	1	M473
4	911 512 086 00	Grille	/R -80	1	M473
-	000 043 205 19	Tesa-moll		1	
5	999 190 010 03	Tubular rivet 3,7 X 9		4	
6	911 512 281 01	Reinforcement plate	-80	1	M473
7	901 503 399 01	Sealing washer	-80	6	M473
8	900 910 012 02	Lock nut NM 6	-80	6	M473
8	900 910 047 09	Lock nut NM 6		6	M473
9	N 011 666 7	Washer B 6,4		6	
10	911 512 283 00	Reinforcement strip	-80	2	M473
11	N 044 734 1	Pan-head screw	-80	6	M473
11	900 067 137 01	Pan-head screw M 5 X 16		6	
11	N 044 734 1	Pan-head screw M 5 X 16	-80	6	M473
11	900 067 137 01	Pan-head screw M 5 X 16		6	
12	900 025 003 02	Washer A 5,3	-80	6	M473
13	911 512 284 00	Reinforcement strip	-80	2	M473
14	900 910 009 02	Lock nut NM 5	-80	6	M473
14	900 084 026 01	Lock nut NM 5		6	M473
15	900 025 003 02	Washer A 5,3	-80	6	M473
16	900 075 145 02	Hexagon-head bolt M 5 X 16	-80	5	M473
17	N 012 005 3	Lock ring B 5	-80	5	M473
18	N 011 665 3	Washer B 5,3		5	M473
18	N 011 665 16	Washer B 5,3		5	M473
19	N 010 207 6	Hexagon-head bolt	-80	2	M473
19	N 010 207 17	Hexagon-head bolt		2	M473
19	N 010 207 6	Hexagon-head bolt M 5 X 12	-80	2	M473
19	N 010 207 17	Hexagon-head bolt M 5 X 12		2	M473
20	N 011 665 3	Washer B 5,3		2	M473
20	N 011 665 16	Washer B 5,3		2	M473
21	900 910 012 02	Lock nut NM 6	-80	5	M473
21	900 910 047 09	Lock nut NM 6		5	M473
22	N 011 666 7	Washer B 6,4	-80	5	M473
23	930 512 010 09	Lid		1	TURBO
(23)	911 512 010 56	Lid	-80	1	SC
(23)	911 512 010 57	Lid	81-	1	SC
24	930 512 023 00	Rear spoiler		1	TURBO
24A	930 512 267 00	Spacer	81-	2	M473 TURBO

Model: 911 78 Model life 1978>>1983

Pos	Part Number	Description	Remark	Qty	Model
24B	999 703 169 40	Cap	81-	1	M473 TURBO
25	930 512 215 00	Piping	81-	1	M473 TURBO
26	N 014 765 2	Pan-head screw M 6 X 10	81-	3	M473 TURBO
27	N 012 226 5	Spring washer A 6	81-	5	M473 TURBO
28	999 507 328 02	Captive nut M 6	81-	5	M473 TURBO
28	999 507 328 0B	Captive nut M 6	81-	5	M473 TURBO
29	900 119 091 02	Pan-head screw M 6 X 15	81-	7	M473 TURBO
30	N 011 524 7	Washer 6,4	81-	10	M473 TURBO
30	N 011 524 27	Washer 6,4	81-	10	M473 TURBO
31	930 512 281 00	Base rail	81-	1	M473 TURBO
32	999 703 013 50	Stopper	81-	2	M473 TURBO
33	930 512 021 00	Polyuret. rim for spoiler	81-	1	M473 TURBO
34	900 910 012 02	Lock nut NM 6	81-	17	M473 TURBO
34	900 910 047 09	Lock nut NM 6	81-	17	M473 TURBO
35	N 011 524 7	Washer A 6,4	81-	17	M473 TURBO
35	N 011 524 27	Washer A 6,4	81-	17	M473 TURBO
36	930 512 031 00	Grille	/L	1	M473 TURBO
(36)	911 512 231 00	Perforated plate	/L 81-	1	M473
(36)	911 799 512 13	Cover	81-	1	M473
37	930 512 032 00	Grille	/R	1	M473 TURBO
(37)	911 512 232 00	Perforated plate	/R 81-	1	M473
38	930 512 175 00	Angular plate	81-	2	M473 TURBO
39	900 143 124 07	Tapping screw 3,5 X 13	81-	2	M473
40	900 143 114 07	Oval-head sheetmetal screw 3,5 X 9,5	81-	6	M473 TURBO
41	930 512 241 00	Air guide		1	M473 TURBO
42	N 014 765 2	Pan-head screw M 6 X 10		4	M473 TURBO
43	N 012 226 5	Spring washer A 6		4	M473 TURBO
44	N 011 666 7	Washer B 6,4		4	M473 TURBO
45	900 143 124 07	Tapping screw 3,5 X 13		2	M473 TURBO
46	900 146 053 07	Oval-head screw M 4 X 18		2	M473 TURBO
47	930 512 044 00	Reinforcement plate		1	M473 TURBO
48	N 013 958 7	Oval-head sheetmetal screw		4	M473 TURBO
48		Oval-head sheetmetal screw 3,5 X 13		4	M473 TURBO
49	900 025 002 02	Washer		5	M473 TURBO
49	900 025 002 03	Washer		5	M473 TURBO
49	900 025 002 02	Washer 4,3		5	M473 TURBO

Model: 911 78

Model life 1978>>1983

Pos	Part Number	Description	Remark	Qty	Model
49	900 025 002 03	Washer 4,3		5	TURBO
50	930 512 110 01	Air guide Spoiler	(D) -79	1	TURBO
51	N 013 958 7	Oval-head sheetmetal screw 3,5 X 13 Special model -USA-	(D) -79	1	TURBO +80
52	911 512 010 07	Spoiler lid		1	
53	911 512 019 00	Rear spoiler		1	
54	900 187 115 02	Combination screw 5,5 X 16		2	
54	900 187 115 01	Combination screw 5,5 X 16		2	
55	901 504 755 20	Tensioning spring		2	
56	900 910 009 02	Lock nut NM 5		4	
56	900 084 026 01	Lock nut NM 5		4	
57	N 011 665 3	Washer 5,3		4	
57	N 011 665 16	Washer 5,3		4	
58	911 512 165 01	Heat shield		1	
59	900 143 001 02	Tapping screw 2,9 X 6,5		2	
60	900 114 013 02	Shake-proof washer 3,2		2	

Model: 911 78

Model life 1978>>1983

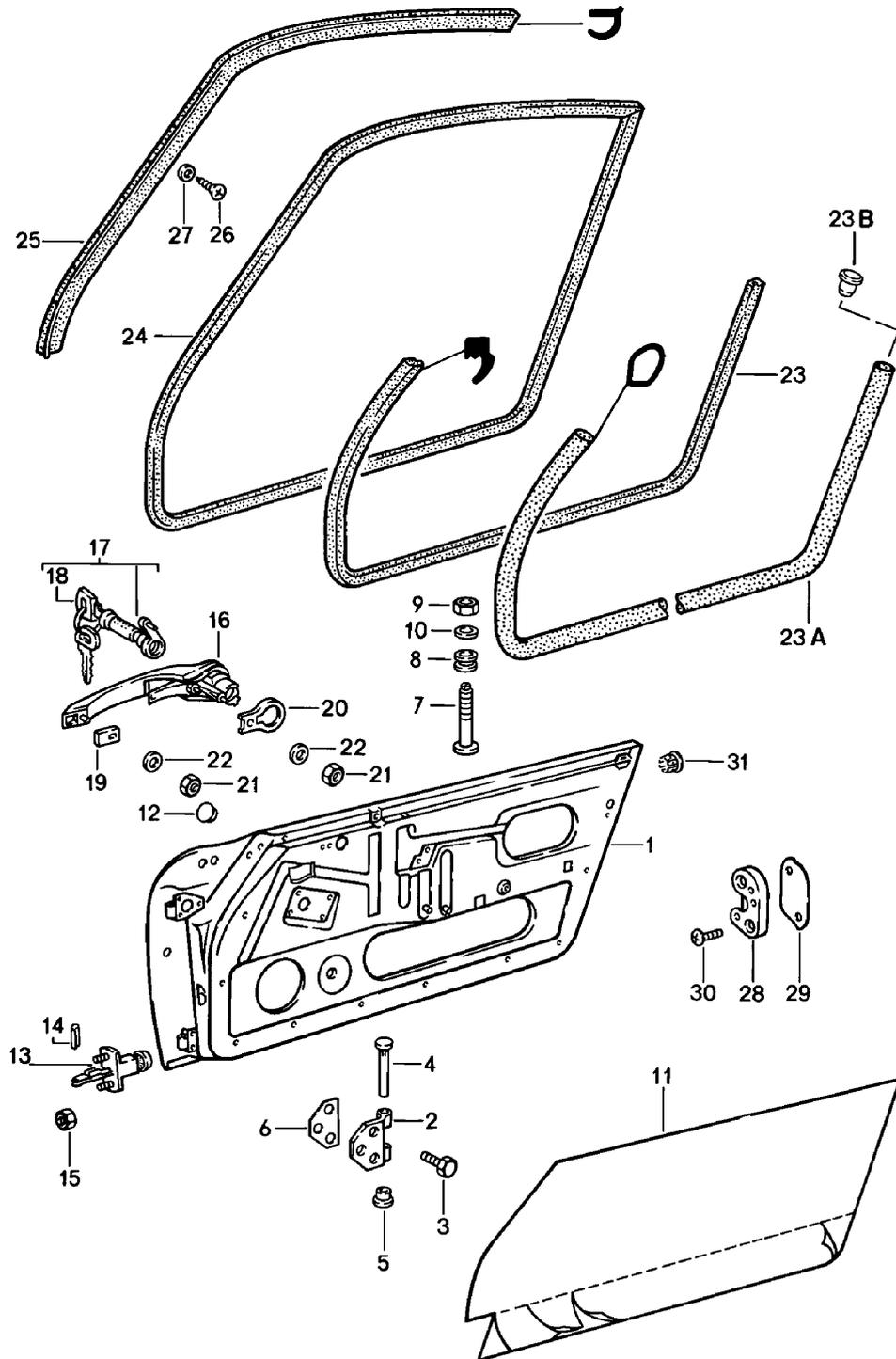

Model: 911 78

Model life 1978>>1983

Pos	Part Number	Description	Remark	Qty	Model
(1)	911 531 005 21	Doors Bare door shell	/L	1	
-	964 531 201 00	Exterior panelling	/L	1	
	964 531 201 00 GRV	Prime coated It is necessary to rework			
1	911 531 006 21	Bare door shell	/R	1	
-	900 145 026 07	Order also: Tapping screw B 4,2 X 22		8	
-	999 591 717 40	Expander nut B 4,2		10	
-	911 531 955 00	Bracket	/L	1	
-	911 531 956 00	Bracket	/R	1	
-	N 011 524 7	Washer A 6,4		4	
-	N 011 524 27	Washer A 6,4		4	
-	999 072 005 09	Hexagon nut M 6 X 12		4	
-	999 072 005 01	Hexagon nut M 6 X 12		4	
-	964 531 202 00	Exterior panelling	/R	1	
	964 531 202 00 GRV	Prime coated It is necessary to rework			
2	901 531 303 21	Hinge arm		4	
3	999 093 010 02	Hexagon-head bolt M 8 X 20		12	
4	901 531 305 20	Hinge bolt		4	
5	901 531 311 20	Bush		8	
6	901 531 391 20	Desk pad		4	
7	911 542 045 00	Adjusting screw	-80	2	TARGA
8	211 959 221	Grommet	-80	2	TARGA
9	900 076 010 02	Nut M 6	-80	2	TARGA
9	900 076 010 0B	Nut M 6	-80	2	TARGA
10	N 011 524 7	Washer 6,4	-80	2	TARGA
10	N 011 524 27	Washer 6,4		2	TARGA
(11)	911 531 889 00	Seal	/L	1	
11	911 531 890 00	Seal	/R	1	
12	999 703 119 40	Stopper		10	
13	911 531 057 01	Door support		2	
13	911 531 057 02	Door arrester		2	
13	911 531 957 00	Door arrester with Set of fastening parts		2	
14	900 309 032 02	Spiral clamping pin		2	
15	900 084 010 02	Lock nut		4	
15	900 910 012 02	Lock nut M 6 Self-locking		4	
15	900 910 047 09	Lock nut M 6 Self-locking		4	
16	911 531 941 00	Outer door handle Chrome without lock cylinder		2	SC
(16)	911 538 941 05	Outer door handle Chrome with lock cylinder W/o stipulated lock number	/L	1	

Model: 911 78 Model life 1978>>1983

Pos	Part Number	Description	Remark	Qty	Model
(16)	911 538 941 04	Outer door handle Chrome with lock cylinder State lock number	/L	1	
(16)	911 538 942 05	Outer door handle Chrome with lock cylinder W/o stipulated lock number	/R	1	
(16)	911 538 942 04	Outer door handle Chrome with lock cylinder State lock number	/R	1	
(16)	911 531 941 28	Outer door handle Black without lock cylinder		2	TURBO
(16)	911 538 941 07	Outer door handle Black with lock cylinder W/o stipulated lock number	/L	1	
(16)	911 538 941 06	Outer door handle Black with lock cylinder State lock number	/L	1	
(16)	911 538 942 07	Outer door handle Black with lock cylinder W/o stipulated lock number	/R	1	
(16)	911 538 942 06	Outer door handle Black with lock cylinder State lock number	/R	1	
(17)	911 531 943 00	Lock cylinder with 2 secondary keys W/o stipulated lock number	/L	1	
(17)	911 531 947 00	Lock cylinder MIT 1 NEBENSCHLUESSEL State lock number	/L	1	
17	911 531 944 00	Lock cylinder with 2 secondary keys W/o stipulated lock number	/R	1	
17	911 531 944 29	Lock cylinder with 2 secondary keys W/o stipulated lock number	/R	1	
17	911 531 948 00	Lock cylinder MIT 1 NEBENSCHLUESSEL State lock number	/R	1	
(18)	911 538 903 00	Blank key		1	
(18)	944 538 041 00	Key lamp		1	
(18)	944 538 041 01	Key lamp		1	
18	911 531 946 00	Main key with Light without Battery State lock number		2	
(18)	911 538 902 00	Replacement key with Key cap State lock number		2	
(18)	914 531 903 11	Information available Blank key Secondary key Single parts		2	

Model: 911 78

Model life 1978>>1983

Pos	Part Number	Description	Remark	Qty	Model
-	911 531 638 00	Key lamp		1	
-	928 537 627 02	Cap		1	
-	911 531 627 02	Pressure spring		1	
-	911 531 640 00	Bulb		1	
		with		1	
		Contact plate			
-	911 531 641 00	Bridge		1	
-	911 531 642 00	Lid		1	
19	911 531 631 00	Desk pad		2	
20	911 531 632 00	Desk pad		2	
21	999 084 102 02	Lock nut		4	
22	900 025 003 02	Washer		4	
		5,3			
23	911 531 093 45	Door seal		2	TARGA
23	911 531 093 46	Door seal		2	TARGA
(23)	911 531 095 40	Door sealing	/L	1	TARGA/CABRIO
(26)	911 531 096 40	Door seal	/R	1	TARGA/CABRIO
23A	911 531 293 60	Door seal		2	CABRIO
23B	911 531 523 65	Cap		2	CABRIO
23B		Cap		2	CABRIO
24	911 531 095 02	Door sealing		2	COUPE
24	911 531 095 03	Door sealing		2	COUPE
(25)	911 542 403 01	Sealing rail	/L	1	COUPE
25	911 542 404 01	Sealing rail	/R	1	COUPE
26	900 145 081 00	Tapping screw		30	
		B 2,9 X 6,5			
27	999 591 009 12	Protection washer		30	
		3,5 MS			
28	911 531 701 02	Door lock striker	/L	1	
		Yellow			
		Chrome			
(28)	911 531 702 02	Door lock striker	/R	1	
		Yellow			
		Chrome			
29	901 531 703 23	Desk pad		X	
		1 MM			
(29)	901 531 703 24	Desk pad		X	
		2 MM			
30	999 219 008 00	Oval-head screw		4	
		M 8 X 40			
31	911 531 243 00	Stopper	/L	1	
		without			
		Alarm system			

Model: 911 78

Model life 1978>>1983

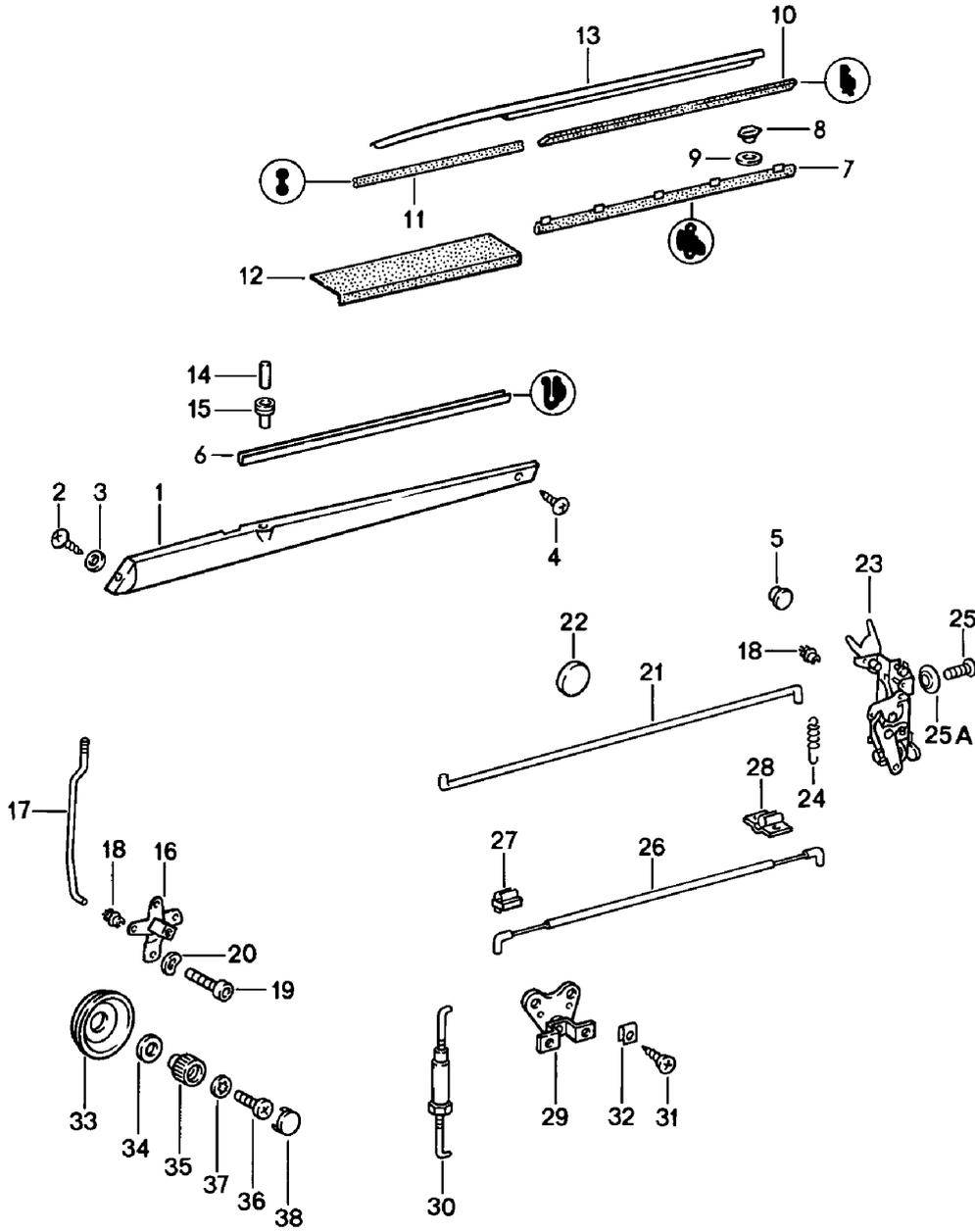

Model: 911 78

Model life 1978>>1983

Pos	Part Number	Description	Remark	Qty	Model
		Installation parts			
		Doors			
1		See group			
		8/07/10			
2	900 145 071 07	Tapping screw		2	
		B 3,5 X 13			
3	999 591 116 07	Cone washer		2	
4	N 013 958 7	Oval-head sheetmetal screw		2	
		B 3,5 X 13			
5	914 552 233 10	Filler piece		2	
	914 552 233 10 01C	Black			
5	914 552 233 10	Filler piece		2	
	914 552 233 10 01C	Black			
6	911 531 951 01	Sealing for door slot		2	
(7)	901 531 935 20	Sealing for door slot	/L	1	
7	901 531 936 20	Sealing for door slot	/R	1	
8	999 591 326 02	Moulding clip		14	
8	999 591 326 01	Moulding clip		14	
9	911 531 309 00	Ring		14	
(10)	911 531 931 02	Sealing strip	/L	1	COUPE
(10)	911 531 931 42	Sealing strip	/L	1	TARGA CABRIO
10	911 531 932 02	Sealing strip	/R	1	COUPE
(10)	911 531 932 42	Sealing strip	/R	1	TARGA CABRIO
11	901 531 933 20	Sealing strip		2	
12	999 915 706 00	Adhesive tape		2	
		19 X 300			
(13)	901 531 431 27	Moulding	/L	1	SC COUPE
		Aluminium			
		Anodised			
(13)	901 531 431 30	Moulding	/L -79	1	COUPE
		Black			
(13)	911 531 431 00	Moulding	/L 80-	1	COUPE
	911 531 431 00 70K	Black			
13	901 531 432 27	Moulding	/R	1	SC COUPE
		Aluminium			
		Anodised			
13	901 531 432 30	Moulding	/R -79	1	COUPE
		Black			
(13)	911 531 432 00	Moulding	/R 80-	1	COUPE
		Right			
	911 531 432 00 70K	Black			
(13)	911 531 042 30	Moulding	/R 80-	1	COUPE
	911 531 042 30 70K	Black			
(13)	901 531 431 41	Moulding	/L	1	TARGA
		Aluminium			
		Anodised			
(13)	901 531 431 50	Moulding	/L -79	1	TARGA
		Black			
(13)	911 531 431 40	Moulding	/L 80-	1	TARGA
	911 531 431 40 70K	Black			CABRIO
(13)	901 531 432 41	Moulding	/R	1	TARGA
		Aluminium			
		Anodised			
(13)	901 531 432 50	Moulding	/R -79	1	TARGA
		Black			
(13)	911 531 432 40	Moulding	/R 80-	1	TARGA
	911 531 432 40 70K	Black			CABRIO
14	928 555 359 02	Locking knob		2	
14		Locking knob		2	
		Doors			
	928 555 359 02 70B	Black			

Model: 911 78

Model life 1978>>1983

Pos	Part Number	Description	Remark	Qty	Model
15	928 555 565 02	Guide sleeve		2	
(16)	911 531 075 01	Mounting for push-button	/L	1	
16	911 531 076 01	Mounting for push-button	/R	1	
(17)	911 531 707 00	Rod for push-button	/L	1	
17	911 531 708 00	Rod for push-button	/R	1	
18	993 531 563 00	Linkage clip		10	
19	900 186 147 02	Pan-head screw M 6 X 10		4	
19	900 976 008 01	Pan-head screw M 6 X 10		4	
20	N 012 226 5	Spring washer B 6		4	
21	911 531 562 00	Connecting rod		2	
22	911 531 599 00	Rubber mounting		4	
(23)	964 531 053 01	Door lock with antishutout mechanism	/L	1	
23	964 531 054 00	Door lock without antishutout mechanism	/LL /R	1	
23	964 531 054 01	Door lock with antishutout mechanism	/RL /R	1	
24	993 531 165 00	Tension spring		2	
25	999 219 009 00	Oval-head screw Micro-self-locking M 6 X 16		6	
25A	999 591 118 02	Washer 6,5		6	
(26)	911 531 509 00	Bowden cable	/L	1	
26	911 531 510 00	Bowden cable	/R	1	
27	911 531 097 00	Support	/V	2	
28	911 531 099 00	Support	/H	2	
29	911 531 083 00	Relay lever		2	
30	911 531 091 00	Pull rod		2	
31	N 014 086 4	Rais. counters. h. tap. s. B 3,5 X 13		4	
32	999 507 009 02	Speed nut 3,5 \$		4	
33	911 531 692 00	Covering		2	
34	911 531 705 00	Spacer ring	-78	2	
34		Spacer ring		2	TURBO
35	911 531 696 00	Rotary knob		2	
36	N 014 133 8	Oval-head screw AM 5 X 12		2	
36	N 014 133 I	Oval-head screw AM 5 X 12		2	
37	900 115 002 01	Serrated lock washer		2	
37	N 012 130 2	Shake-proof washer J 5,3		2	
38	911 531 703 00	Cap		2	

Model: 911 78

Model life 1978>>1983

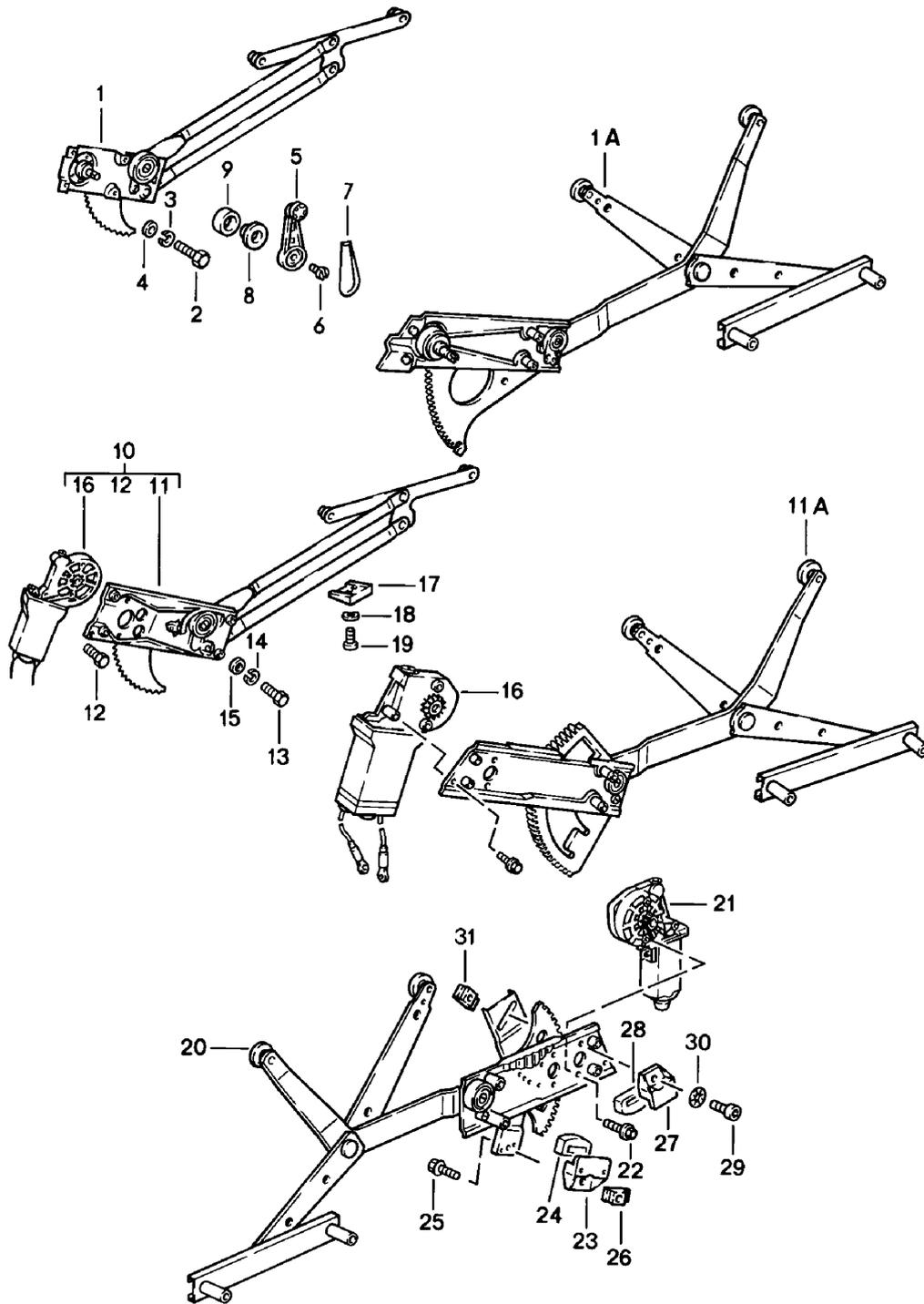

Model: 911 78 Model life 1978>>1983

Pos	Part Number	Description	Remark	Qty	Model
		Power windows Mechanical See TPI Group 8 NR.5/80 See illustrations 8/05/00 Use also: POS.11	-79		
(1A)	911 542 929 03	Power windows	/L	1	COUPE
(1A)	911 542 929 42	Cross-arm	/L	1	TARGA
1A	911 542 930 03	Cross-arm	/R	1	COUPE
(1A)	911 542 930 42	Cross-arm	/R	1	TARGA
2	N 010 210 13	Hexagon-head bolt M 6 X 10		8	
3	N 012 006 4	Lock ring B 6		8	
4	N 011 524 7	Washer 6,4		8	
4	N 011 524 27	Washer 6,4		8	
5	911 542 471 01	Window crank		2	
6	911 542 475 00	Conical screw		2	
7	901 542 482 20	Cover		2	
7		Cover		2	
	901 542 482 20 700	Black			
8	901 552 891 20	Rosette		2	
9	901 542 495 20	Sealing ring		2	
9	901 542 495 21	Sealing ring		2	
12	999 093 004 02	Hexagon-head bolt M 6 X 16		6	
13	999 217 022 02	Hexagon-head bolt M 6 X 16		8	
14	N 012 006 4	Lock ring B 6		8	
15	N 011 524 7	Washer 6,4		8	
15	N 011 524 27	Washer 6,4		8	
(16)	911 624 015 01	Motor	/L	1	COUPE
(16)	911 624 014 01	Motor	/R	1	COUPE
17	901 542 063 00	Stop wedge		2	
18	N 012 222 4	Spring washer		4	
18		Spring washer A 5		4	
19	900 119 011 02	Pan-head screw M 5 X 10		4	
20	911 542 933 42	Cross-arm	/L	1	TARGA
20	911 542 935 44	Cross-arm without Engine and transmission	/L	1	TARGA CABRIO
-	911 542 057 42	Window lifter rail	-82 /L -82	1	TARGA
(20)	911 542 934 42	Cross-arm	/R	1	TARGA
(20)	911 542 936 44	Cross-arm without Engine and transmission	/R	1	TARGA CABRIO
-	911 542 058 42	Window lifter rail	-82 /R -82	1	TARGA
21	911 624 015 41	Motor	/L	1	TARGA CABRIO
(21)	911 624 014 41	Motor	/R	1	TARGA CABRIO

Model: 911 78 Model life 1978>>1983

Pos	Part Number	Description	Remark	Qty	Model
22	999 217 028 02	Hexagon-head bolt M 6 X 16		6	
23	911 542 937 42	Stop bracket Lower	/L	1	
(23)	911 542 938 42	Stop bracket Lower	/R	1	
24	911 542 235 40	Stop		2	
25	999 217 004 02	Combination screw M 6 X 12		2	
26	N 011 052 4	Square nut M 6		2	
27	911 542 943 42	Stop bracket Upper	/L	1	
(27)	911 542 944 42	Stop bracket Upper	/R	1	
28	911 542 939 42	Insert		2	
29	900 067 008 02	Pan-head screw M 6 X 12		2	
29	900 067 008 03	Pan-head screw M 6 X 12		2	
30	999 523 104 02	Lock washer M 6		2	
31	999 084 424 02	Lock nut M 6		2	

Model: 911 78

Model life 1978>>1983

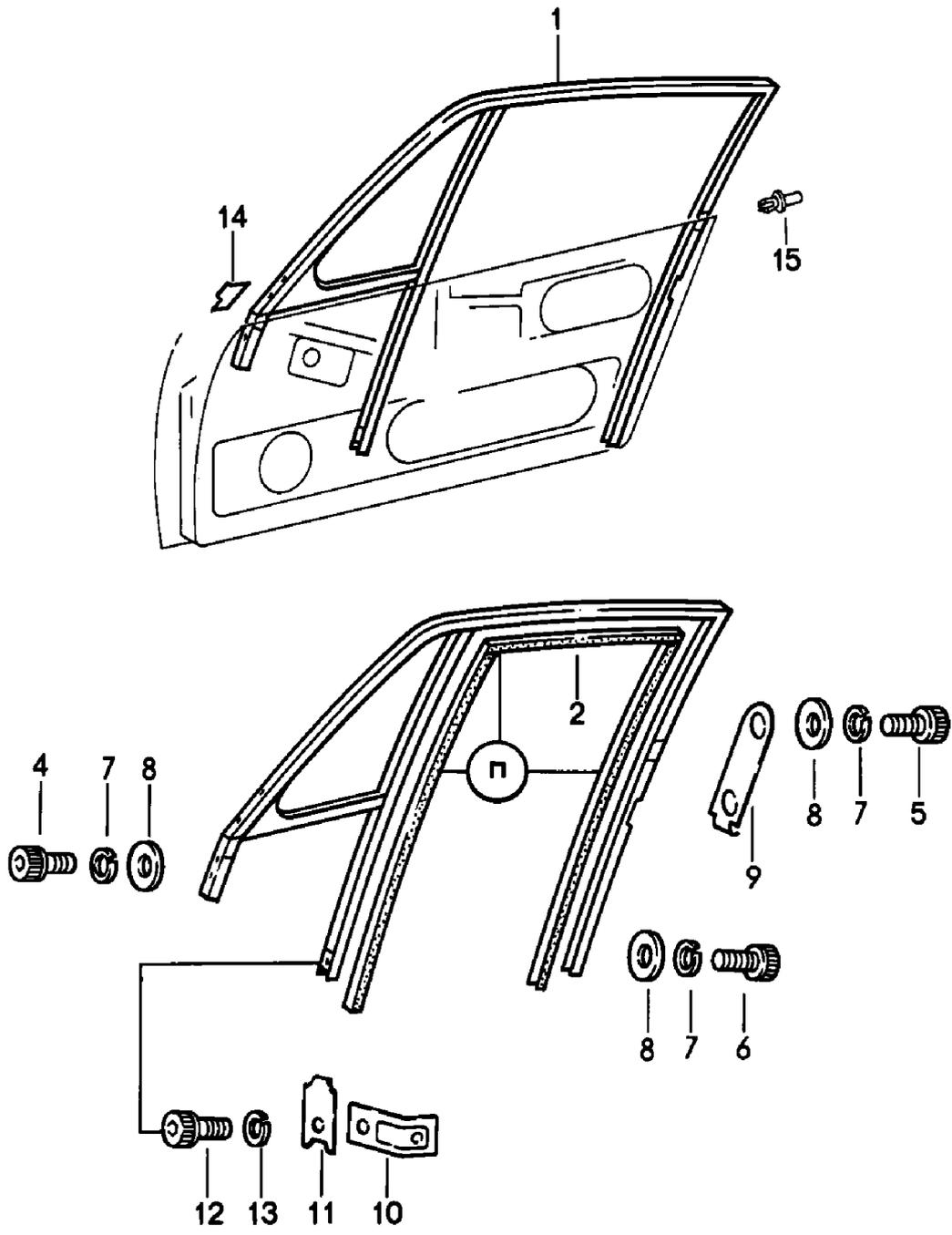

Model: 911 78

Model life 1978>>1983

Pos	Part Number	Description	Remark	Qty	Model
(1)	901 542 021 27	Door glass frame Door glass frame Chrome	/L -79	1	+COUPE SC
(1)	901 542 021 28	Door glass frame Black	/L -79	1	
1	911 542 029 01	Door glass frame	/L 80-	1	
	911 542 029 01 70K	Black			
1	901 542 022 27	Door glass frame Chrome	/R -79	1	SC
1	901 542 022 28	Door glass frame Black	/R -79	1	
1	911 542 030 01	Door glass frame	/R 80-	1	
	911 542 030 01 70K	Black			
2	911 542 905 00	Window guide Comprising: Position 2+3		2	
4	900 119 052 02	Pan-head screw M 8 X 16		4	
5	999 218 008 02	Pan-head screw M 8 X 12		2	
5	900 119 018 03	Pan-head screw M 8 X 12		2	
6	900 119 052 02	Pan-head screw M 8 X 16		2	
7	900 027 015 02	Lock ring B 8		8	
7	900 027 015 03	Lock ring B 8		8	
8	900 025 007 02	Washer 8,4		8	
8	900 025 007 03	Washer 8,4		8	
9	901 542 299 25	Cover plate		2	
10	911 542 061 00	Retaining bracket		2	
11	901 542 252 25	Desk pad		2	
12	900 119 052 02	Pan-head screw M 8 X 16		2	
13	900 027 015 02	Lock ring B 8		2	
13	900 027 015 03	Lock ring B 8		2	
(14)	911 531 711 01	Joint rubber	/V /L	1	
14	911 531 712 01	Joint rubber	/V /R	1	
(14)	911 531 713 01	Joint rubber	/H /L	1	
(14)	911 531 714 01	Joint rubber	/H /R	1	
15	999 591 429 40	Expansion rivet		2	

Model: 911 78

Model life 1978>>1983

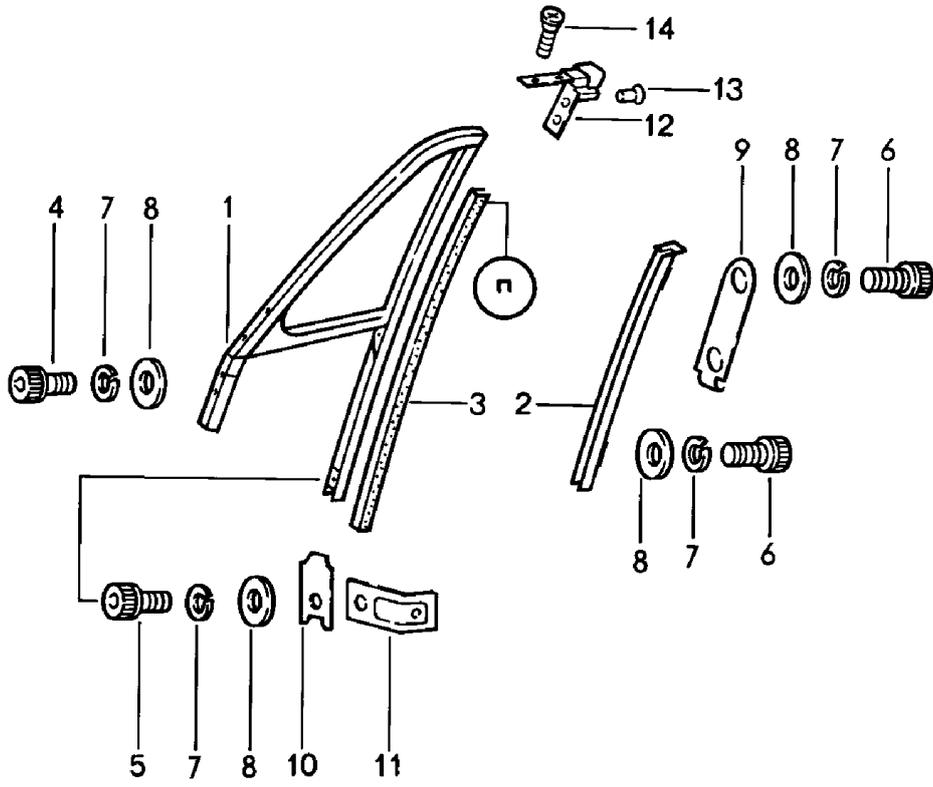

Model: 911 78

Model life 1978>>1983

Pos	Part Number	Description	Remark	Qty	Model
		Door glass frame			+TARGA/CABRI
(1)	911 542 019 40	Door glass frame Chrome	/L -79	1	
(1)	911 542 019 41	Door glass frame Black	/L -79	1	
(1)	911 542 019 43	Door glass frame	/L 80-	1	
	911 542 019 43 70K	Black			
1	911 542 020 40	Door glass frame Chrome	/R -79	1	
1	911 542 020 41	Door glass frame Black	/R -79	1	
1	911 542 020 43	Door glass frame	/R 80-	1	
	911 542 020 43 70K	Black			
(2)	901 542 023 40	Window guide rail Chrome	/L -79	1	
(2)	901 542 023 48	Window guide rail Black	/L -79	1	
(2)	901 542 023 40	Window guide rail Black	/L 80-	1	
2	901 542 024 40	Window guide rail Chrome	/R -79	1	
(2)	901 542 024 48	Window guide rail Black	/R -79	1	
(2)	911 542 036 40	Window guide rail Black	/R 80-	1	
3	911 542 505 40	Window guide		2	
4	900 119 091 02	Pan-head screw M 6 X 15		4	
5		Pan-head screw M 6 X 15		6	
6	900 119 035 02	Pan-head screw M 6 X 8		6	
7	N 012 006 4	Lock ring B 6		14	
8	N 011 524 7	Washer 6,4		14	
8	N 011 524 27	Washer 6,4		14	
9	901 542 299 20	Cover plate		2	
10	901 542 252 20	Desk pad		2	
10	901 542 252 25	Desk pad		2	
11	911 542 061 00	Retaining bracket		2	
(12)	911 542 065 41	Frame connection	/L	1	
(12)		Frame connection	/L	1	
12	911 542 066 41	Frame connection	/R	1	
12		Frame connection	/R	1	
13	900 056 003 20	Rivet		4	
14	900 270 051 00	Rais. counters. h. tap. s. AM 4 X 8 ROSTFREI	-79	4	
14	900 270 051 0A	Rais. counters. h. tap. s. AM 4 X 8 ROSTFREI		4	
14	900 270 050 07	Countersunk-head screw M 5 X 8	80-	4	

Model: 911 78

Model life 1978>>1983

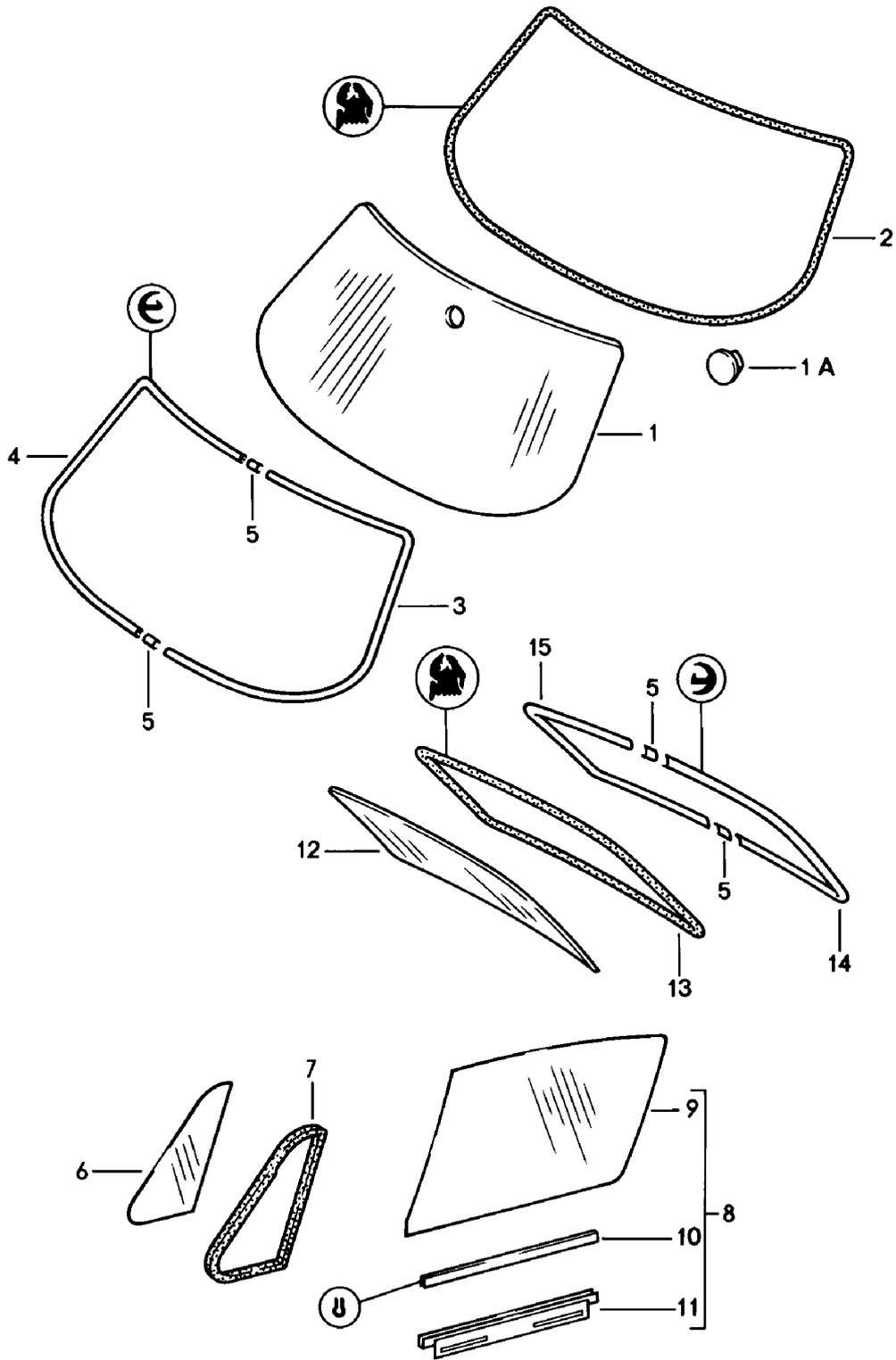

Model: 911 78

Model life 1978>>1983

Pos	Part Number	Description	Remark	Qty	Model
1	911 541 011 00	window glazing Windscreen Clear Not for (USA)(CDN)		1	
(1)	911 541 011 04	Windscreen Tinted with Antenna		1	
(1)	911 541 011 26	Windscreen Tinted with Antenna		1	
(1)	911 541 011 21	Windscreen Tinted Heated		1	
(1)	911 541 011 02	Windscreen	80-81	1	
(1)	911 541 011 05	Windscreen Tinted Green top tint with Antenna	80-	1	
(1)	911 541 011 27	Windscreen Tinted Green top tint with Antenna	80-	1	
(1)	930 541 011 02	Windscreen Tinted Green top tint Heated		1	
1A	477 845 043	Retainer plate		1	
2	911 541 225 00	Windscreen sealing		1	
2	911 541 225 02	Sealing frame		1	
2	911 541 225 03	Sealing frame		1	
2	911 541 225 04	Sealing frame		1	
3	901 541 911 20	Trim frame-half Chrome	/L -79	1	
(3)	911 541 911 01	Trim frame	/L	1	
	911 541 911 01 70K	Black			
(3)	911 541 911 01	Trim frame	/L	1	
	911 541 911 01 70K	Black			
4	901 541 912 20	Trim frame-half Chrome	/R -79	1	
(4)	911 541 912 01	Trim frame-half	/R	1	
	911 541 912 01 70K	Black			
(4)	911 541 912 01	Trim frame-half	/R	1	
	911 541 912 01 70K	Black			
5	644 541 921 06	Covering plate Chrome	-79	4	
(5)	911 541 921 01	Covering plate		4	
	911 541 921 01 70K	Black			
(5)	911 541 921 01	Covering plate		4	
	911 541 921 01 70K	Black			
6	901 542 501 27	Side window Clear Not for (USA)(CDN)	/L	1	SC
(6)	911 542 511 00	Side window Tinted	/L	1	
(6)	901 542 502 27	Side window Not for (USA)(CDN)	/R	1	SC

Model: 911 78

Model life 1978>>1983

Pos	Part Number	Description	Remark	Qty	Model
(6)	911 542 512 00	Side window Tinted	/R	1	
7	901 542 921 21	Sealing frame	/L	1	
(7)	901 542 922 21	Sealing frame	/R	1	
8	901 542 011 27	Door window glass Clear Parallel arm window lift Not for (USA)(CDN)	/L -79	1	SC
(8)	911 542 011 01	Door window glass Clear Cross arm window lift Not for (USA)(CDN)	/L 80-	1	SC
(8)	901 542 011 37	Door window glass Tinted Parallel arm window lift	/L -79	1	
(8)	911 542 011 02	Door window glass Tinted Cross arm window lift	/L 80-	1	
(8)	901 542 012 27	Door window glass Clear Parallel arm window lift Not for (USA)(CDN)	/R -79	1	SC
(8)	911 542 012 01	Door window glass Clear Cross arm window lift Not for (USA)(CDN)	/R 80-	1	SC
(8)	901 542 012 37	Door window glass Tinted Parallel arm window lift	/R -79	1	
(8)	911 542 012 02	Door window glass Tinted Cross arm window lift Power windows	/R 80-	1	
9	901 542 101 25	Side window Clear Not for (USA)(CDN)	/L	1	SC
(9)	901 542 101 35	Side window Tinted	/L	1	
(9)	901 542 102 25	Side window Clear Not for (USA)(CDN)	/R	1	SC
(9)	901 542 102 35	Side window Tinted	/R	1	
10	911 542 491 40	Rubber ply		2	
10		Rubber ply		2	
11	901 542 045 23	Window lifter rail Parallel arm window lift	/L -79	1	
(11)	911 542 057 00	Window lifter rail Cross arm window lift	/L 80-	1	
(11)	901 542 046 23	Window lifter rail Parallel arm window lift	/R -79	1	
(11)	911 542 058 00	Window lifter rail Cross arm window lift	/R 80-	1	
12	911 545 105 00	Rear window Clear Single-stage heating		1	SC
12	911 545 105 02	Rear window		1	SC

Model: 911 78 Model life 1978>>1983

Pos	Part Number	Description	Remark	Qty	Model
(12)	911 545 107 00	Clear Single-stage heating Rear window Tinted		1	
(12)	911 545 107 07	Two-stage heatable Rear window Tinted		1	
13	901 545 901 21	Two-stage heatable Sealing frame		1	
13	911 545 225 00	Sealing frame		1	
14	901 545 911 20	It is necessary to rework Trim frame-half Chrome	/L -79	1	SC
(14)	911 545 911 00	Trim frame	/L	1	
	911 545 911 00 70K	Black			
(14)	911 545 911 00	Trim frame	/L	1	
	911 545 911 00 70K	Black			
15	901 545 912 20	Trim frame-half Chrome	/R -79	1	SC
(15)	911 545 912 00	Trim frame-half	/R	1	
	911 545 912 00 70K	Black			
(15)	911 545 912 00	Trim frame-half	/R	1	
	911 545 912 00 70K	Black			

Model: 911 78

Model life 1978>>1983

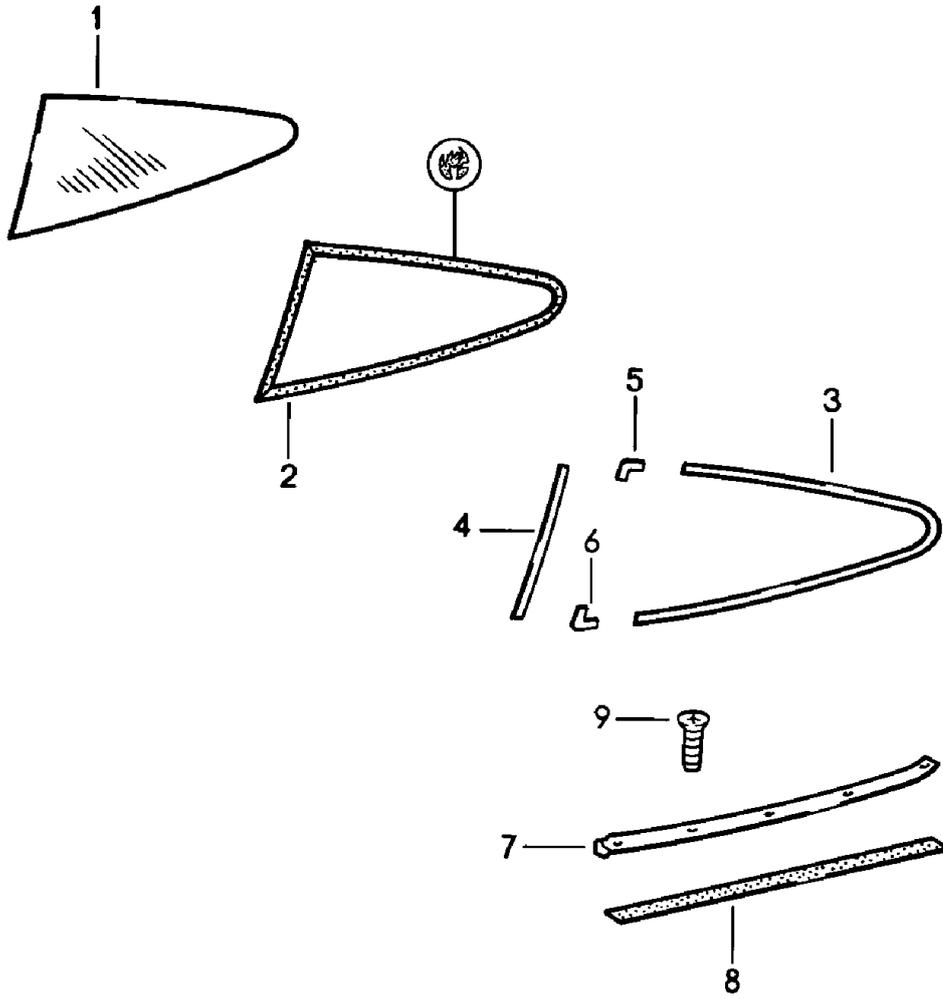

Model: 911 78 Model life 1978>>1983

Pos	Part Number	Description	Remark	Qty	Model
1	911 543 101 01	window glazing Rear window Clear Not for (USA)(CDN)	/L	1	+COUPE SC
(1)	911 543 101 02	Rear window Tinted	/L	1	
(1)	911 543 102 01	Rear window Clear Not for (USA)(CDN)	/R	1	SC
(1)	911 543 102 02	Rear window Tinted	/R	1	
(1)	911 543 102 07	Rear window Tinted	/R	1	
2	911 543 035 01	Sealing frame	/L	1	
2	911 543 036 01	Sealing frame	/R	1	
3	911 543 419 00	Moulding Chrome	/L -79	1	SC
(3)	911 543 419 28	Moulding Black	/L -79	1	
(3)	911 543 419 01	Moulding Black	/L 80-	1	
(3)	911 543 419 02	Moulding for	/L 80-	1	
(3)	911 543 419 02 70K	Black			
(3)	911 543 420 00	Moulding Chrome	/R -79	1	SC
(3)	911 543 420 28	Moulding Black	/R -79	1	
(3)	911 543 420 01	Moulding Black	/R 80-	1	
4	911 543 197 00	Moulding Chrome	/L -79	1	SC
(4)	911 543 197 01	Moulding Black	/L -79	1	
(4)		Moulding Black	/L 80-	1	
(4)	911 543 198 00	Moulding Chrome	/R -79	1	SC
(4)	911 543 198 01	Moulding Black	/R -79	1	
(4)		Moulding Black	/R 80-	1	
5	911 543 187 00	Covering plate Chrome	-79	2	SC
(5)	911 543 187 01	Covering plate Black	-79	2	
(5)		Covering plate Black	80-	2	
6	911 543 185 00	Covering plate Chrome	-79	2	SC
(6)	911 543 185 28	Covering plate Black	-79	2	
(6)	911 543 185 01	Covering plate Black	80-	2	
7	911 543 195 00	Moulding Chrome	/L -79	1	SC
(7)	911 543 195 02	Moulding Black	/L -79	1	
(7)		Moulding Black	/L 80-	1	
(7)	911 543 195 02 70K	Black			
(7)	911 543 196 00	Moulding	/R -79	1	SC

Model: 911 78

Model life 1978>>1983

Pos	Part Number	Description	Remark	Qty	Model
(7)	911 543 196 28	Chrome Moulding	/R -79	1	
(7)	911 543 196 02	Black Moulding	/R 80-	1	
	911 543 196 02 70K	Black			
8	000 043 129 00	Sealing strap		X	
9	900 144 009 00	Counters. head tapp. screw	-79	12	SC
		B 2,9 X 13 VERZ.			
(9)	900 144 017 07	Tapping screw		12	
		B 2,9 X 13			
		Black			

Model: 911 78

Model life 1978>>1983

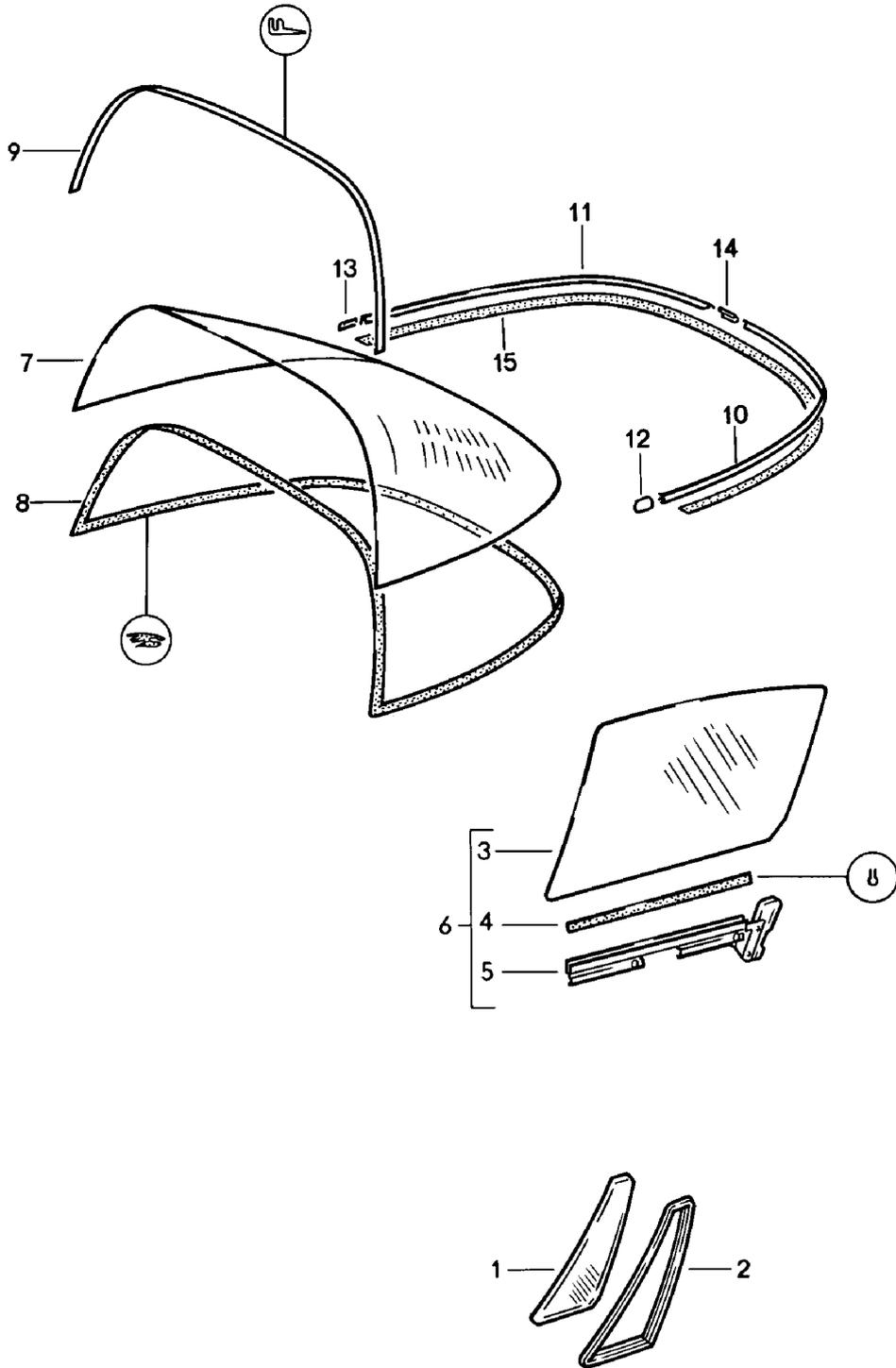

Model: 911 78 Model life 1978>>1983

Pos	Part Number	Description	Remark	Qty	Model
		window glazing Windscreen See group 8/05/00			+TARGA/CABRI
1	911 542 503 40	Side window Clear Not for (USA)(CDN)	/L	1	
(1)	911 542 503 41	Side window Tinted	/L	1	
(1)	911 542 504 40	Side window Clear Not for (USA)(CDN)	/R	1	
(1)	911 542 504 41	Side window Tinted	/R	1	
2	911 799 542 85	Sealing frame		2	
3	901 542 101 40	Door window glass	/L -82	1	
3	911 542 101 40	Door window glass Clear Not for (USA)(CDN)	/L 83-	1	
(3)	901 542 101 45	Door window glass	/L -82	1	
(3)	911 542 101 45	Door window glass Tinted	/L 83-	1	
(3)	901 542 102 40	Door window glass	/R -82	1	
(3)	911 542 102 40	Door window glass Clear Not for (USA)(CDN)	/R 83-	1	
(3)	901 542 102 45	Door window glass	/R -82	1	
(3)	911 542 102 45	Door window glass Tinted	/R 83-	1	
4	911 542 491 40	Rubber ply	-79	2	
4		Rubber ply		2	
5	901 542 043 43	Window lifter rail Parallel arm window lift	/L -79	1	
5	911 542 057 42	Window lifter rail Cross arm window lift	/L 80-	1	
(5)	901 542 044 43	Window lifter rail Parallel arm window lift	/R -79	1	
(5)	911 542 058 40	Window lifter rail Cross arm window lift	/R 80-82	1	
(5)	911 542 058 42	Window lifter rail Cross arm window lift	/R 83-	1	
6	901 542 011 43	Door window glass Clear Parallel arm window lift Not for (USA)(CDN)	/L -79	1	
(6)	911 542 011 40	Door window glass	/L 80-82	1	
(6)	911 542 011 42	Door window glass Clear Cross arm window lift Not for (USA)(CDN)	/L 83-	1	
(6)	901 542 011 47	Door window glass Tinted Parallel arm window lift	/L -79	1	
(6)	911 542 011 41	Door window glass	/L 80-82	1	
(6)	911 542 011 44	Door window glass Tinted Cross arm window lift	/L 83-	1	

Model: 911 78 Model life 1978>>1983

Pos	Part Number	Description	Remark	Qty	Model
(6)	901 542 012 43	Door window glass Clear Parallel arm window lift Not for (USA)(CDN)	/R -79	1	
(6)	911 542 012 40	Door window glass	/R 80-82	1	
(6)	911 542 012 42	Door window glass Clear Cross arm window lift Not for (USA)(CDN)	/R 83-	1	
(6)	901 542 012 47	Door window glass Tinted Parallel arm window lift	/R -79	1	
(6)	911 542 012 41	Door window glass	/R 80-82	1	
(6)	911 542 012 44	Door window glass Tinted Cross arm window lift	/R 83-	1	
7	911 565 551 03	Rear window Tinted Two-stage heatable		1	TARGA
8	911 545 051 41	Sealing frame		1	TARGA
9	901 565 930 41	Gasket		1	TARGA
10	901 565 555 40	Moulding Chrome	/L -79	1	TARGA
(10)	911 565 555 41	Moulding	/L	1	TARGA
	911 565 555 41 70K	Black			
11	901 565 556 40	Moulding Chrome	/R -79	1	TARGA
(11)	911 565 556 41	Moulding	/R	1	TARGA
	911 565 556 41 70K	Black			
12	901 565 561 40	Moulding end Chrome	/L -79	1	TARGA
(12)	911 565 569 40	Moulding	/L	1	TARGA
	911 565 569 40 70K	Black			
13	901 565 562 40	Moulding end Chrome	/R -79	1	TARGA
(13)	911 565 570 40	Moulding	/R	1	TARGA
	911 565 570 40 70K	Black			
14	644 541 921 06	Covering plate Chrome	-79	1	TARGA
14	911 541 921 01	Covering plate		1	
	911 541 921 01 70K	Black			
14	911 541 921 01	Covering plate		1	
	911 541 921 01 70K	Black			
15	000 043 129 00	Sealing strap		X	

Model: 911 78

Model life 1978>>1983

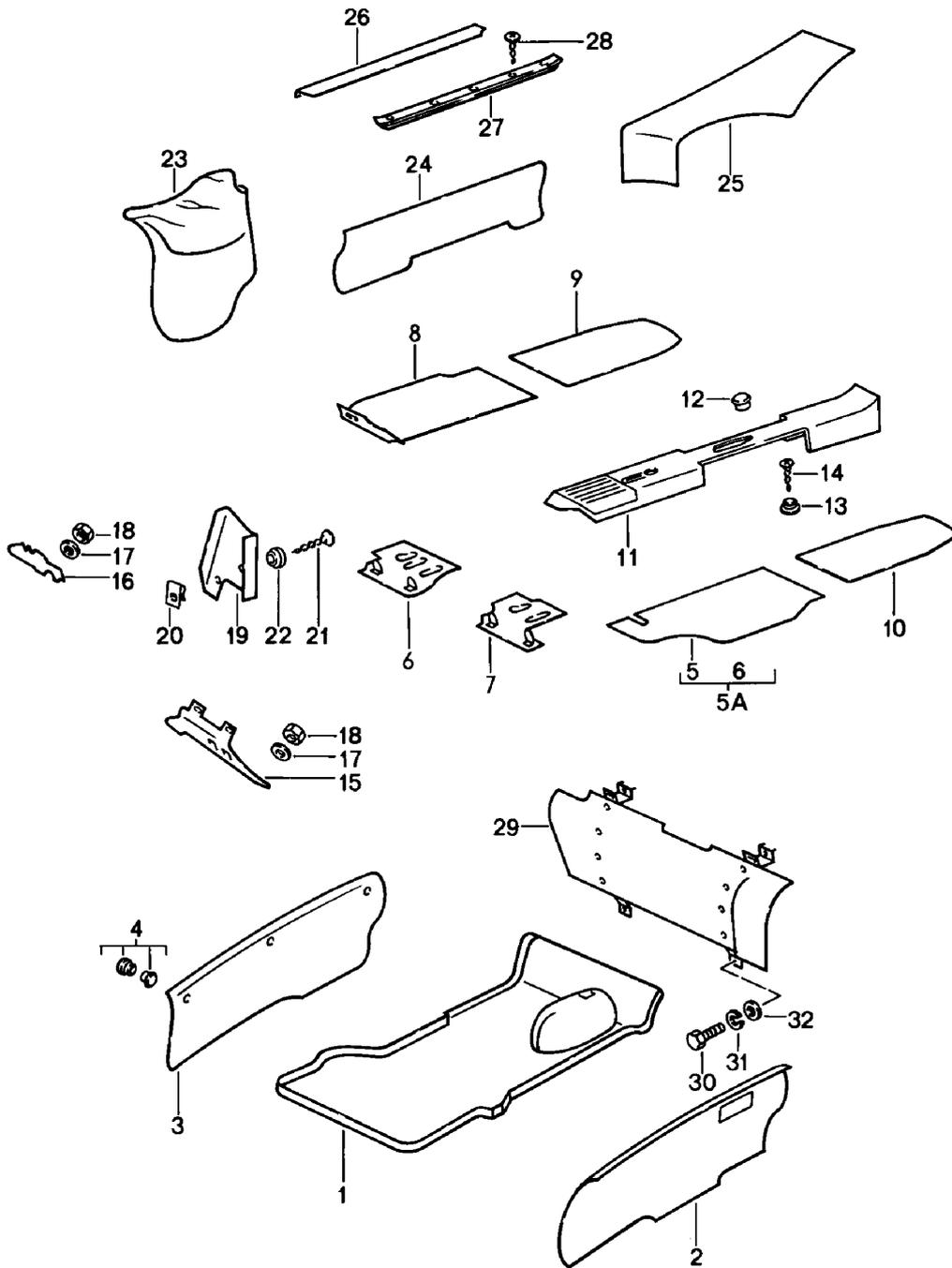

Model: 911 78 Model life 1978>>1983

Pos	Part Number	Description	Remark	Qty	Model
		Interior equipment			
		Front			
1	911 551 045 03	Front-compartment carpet	/LL	1	
(1)	911 551 045 05	Front-compartment carpet	/RL	1	
2	911 551 049 02	Front boot side wall	/L	1	
3	911 551 050 00	Front boot side wall	/R -79	1	
3	911 551 050 01	Front boot side wall	/R	1	
4	911 503 075 00	Desk pad		6	
5	911 551 021 00	Carpet	/LL /L	1	COUPE
		Velour pile	-78		
	911 551 021 00 8AB	Lobster			
	911 551 021 00 5AZ	Cork			
	911 551 021 00 7AZ	Black			
	911 551 021 00 20B	Dark green			
	911 551 021 00 40A	Brown			
	911 551 021 00 8AZ	Light red			
	911 551 021 00 1AY	Yellow			
5	911 551 021 00	Carpet	/LL /L	1	COUPE
		Cut pile	79-		
	911 551 021 00 5AF	Cork			
	911 551 021 00 70E	Black			
	911 551 021 00 2AF	Dark green			
	911 551 021 00 40E	Brown			
	911 551 021 00 8AF	Light red			
	911 551 021 00 1AF	Yellow			
	911 551 021 00 30B	Dark blue	80-		
	911 551 021 00 50B	Beige	80-		
	911 551 021 00 20S	Mint green	81-		
	911 551 021 00 80E	Burgundy			
	911 551 021 00 60A	Grey	83-		
	911 551 021 00 2FL	Grey-beige	83-		
	911 551 021 00 6JD	Dark green	83-		
	911 551 021 00 80S	Can-can-red	83-		
	911 551 021 00 1VD	Champagne	83-		
(5)	911 551 021 01	Carpet	/LL /L	1	COUPE M399 SPM
		Velour pile	-78		
	911 551 021 01 8AB	Lobster			
	911 551 021 01 5AZ	Cork			
	911 551 021 01 7AZ	Black			
	911 551 021 01 20B	Dark green			
	911 551 021 01 40A	Brown			
	911 551 021 01 8AZ	Light red			
	911 551 021 01 1AY	Yellow			
(5)	911 551 021 01	Carpet	/LL /L	1	COUPE M399 SPM
		Cut pile	79-		
	911 551 021 01 5AF	Cork			
	911 551 021 01 70E	Black			
	911 551 021 01 2AF	Dark green			
	911 551 021 01 40E	Brown			
	911 551 021 01 8AF	Light red			
	911 551 021 01 1AF	Yellow			
	911 551 021 01 30B	Dark blue	80-		
	911 551 021 01 50B	Beige	80-		
(5)	911 551 021 40	Carpet	/LL /L	1	TARGA/CABRIO
		Velour pile	-78		
	911 551 021 40 8AB	Lobster			
	911 551 021 40 5AZ	Cork			
	911 551 021 40 7AZ	Black			
	911 551 021 40 20B	Dark green			

Model: 911 78 Model life 1978>>1983

Pos	Part Number	Description	Remark	Qty	Model
(5)	911 551 021 40 40A	Brown		1	TARGA/CABRIO
	911 551 021 40 8AZ	Light red			
	911 551 021 40 1AY	Yellow			
	911 551 021 40	Carpet	/LL /L		
		Cut pile	79-		
	911 551 021 40 5AF	Cork			
	911 551 021 40 70E	Black			
	911 551 021 40 2AF	Dark green			
	911 551 021 40 40E	Brown			
	911 551 021 40 8AF	Light red			
	911 551 021 40 1AF	Yellow			
	911 551 021 40 30B	Dark blue	80-		
	911 551 021 40 50B	Beige	80-		
	911 551 021 40 20S	Mint green	81-		
(5)	911 551 021 40 80E	Burgundy		1	TARGA:SPM
	911 551 021 40 60A	Grey	83-		
	911 551 021 40 2FL	Grey-beige	83-		
	911 551 021 40 6JD	Dark green	83-		
	911 551 021 40 80S	Can-can-red	83-		
	911 551 021 40 1VD	Champagne	83-		
	911 551 021 41	Carpet	/LL /L -80		
		Velour pile	-78		
	911 551 021 41 8AB	Lobster			
	911 551 021 41 5AZ	Cork			
	911 551 021 41 7AZ	Black			
	911 551 021 41 20B	Dark green			
	911 551 021 41 40A	Brown			
	911 551 021 41 8AZ	Light red			
911 551 021 41 1AY	Yellow				
(5)	911 551 021 41	Carpet	/LL /L -80	1	TARGA:SPM
		Cut pile	79-		
	911 551 021 41 5AF	Cork			
	911 551 021 41 70E	Black			
	911 551 021 41 2AF	Dark green			
	911 551 021 41 40E	Brown			
	911 551 021 41 8AF	Light red			
	911 551 021 41 1AF	Yellow			
	911 551 021 41 30B	Dark blue	80		
	911 551 021 41 50B	Beige	80		
	911 551 021 41 80E	Burgundy			
	911 551 911 00	Floor mat	/LL /L		
		with			
		Logo	911		
(5A)	911 551 911 00 4KD	Brown		1	COUPE
	911 551 911 00 7KD	Black			
	911 551 911 00 3KD	Blue			
	911 551 011 06	Carpet	/RL /L		
(5A)		Velour pile	-78	1	COUPE M399/559
	911 551 011 06 8AB	Lobster			
	911 551 011 06 5AZ	Cork			
	911 551 011 06 7AZ	Black			
	911 551 011 06 20B	Dark green			
	911 551 011 06 40A	Brown			
	911 551 011 06 8AZ	Light red			
	911 551 011 06 1AY	Yellow			
	911 551 011 08	Carpet	/RL /L		
		Velour pile	-78		
	911 551 011 08 8AB	Lobster			
	911 551 011 08 5AZ	Cork			
	911 551 011 08 7AZ	Black			
	911 551 011 08 20B	Dark green			

Model: 911 78 Model life 1978>>1983

Pos	Part Number	Description	Remark	Qty	Model
(5A)	911 551 011 08 40A	Brown		1	COUPE
	911 551 011 08 8AZ	Light red			
	911 551 011 08 1AY	Yellow			
	911 551 011 06	Carpet	/RL /L		
		Cut pile	79-		
	911 551 011 06 5AF	Cork			
	911 551 011 06 70E	Black			
	911 551 011 06 2AF	Dark green			
	911 551 011 06 40E	Brown			
	911 551 011 06 8AF	Light red			
	911 551 011 06 1AF	Yellow			
	911 551 011 06 30B	Dark blue	80-		
	911 551 011 06 50B	Beige	80-		
	911 551 011 06 20S	Mint green	81-		
(5A)	911 551 011 06 80E	Burgundy		1	COUPE M399/559
	911 551 011 06 60A	Grey	83-		
	911 551 011 06 2FL	Grey-beige	83-		
	911 551 011 06 6JD	Dark green	83-		
	911 551 011 06 80S	Can-can-red	83-		
	911 551 011 06 1VD	Champagne	83-		
	911 551 011 08	Carpet	/RL /L		
		Cut pile	79-		
	911 551 011 08 5AF	Cork			
	911 551 011 08 70E	Black			
	911 551 011 08 2AF	Dark green			
	911 551 011 08 40E	Brown			
	911 551 011 08 8AF	Light red			
	911 551 011 08 1AF	Yellow			
911 551 011 08 30B	Dark blue	80-			
(5A)	911 551 011 08 50B	Beige	80-	1	COUPE:SPM
	911 551 011 08 20S	Mint green	81-		
	911 551 011 08 80E	Burgundy			
	911 551 011 08 60A	Grey	83-		
	911 551 011 08 2FL	Grey-beige	83-		
	911 551 011 08 6JD	Dark green	83-		
	911 551 011 08 80S	Can-can-red	83-		
	911 551 011 08 1VD	Champagne	83-		
	911 551 011 04	Carpet	/RL /L		
		Velour pile	-78		
	911 551 011 04 8AB	Lobster			
	911 551 011 04 5AZ	Cork			
	911 551 011 04 7AZ	Black			
	911 551 011 04 20B	Dark green			
(5A)	911 551 011 04 40A	Brown		1	COUPE:SPM
	911 551 011 04 8AZ	Light red			
	911 551 011 04 1AY	Yellow			
	911 551 011 04	Carpet	/RL /L		
		Cut pile	79-		
	911 551 011 04 5AF	Cork			
	911 551 011 04 70E	Black			
	911 551 011 04 2AF	Dark green			
	911 551 011 04 40E	Brown			
	911 551 011 04 8AF	Light red			
	911 551 011 04 1AF	Yellow			
	911 551 011 04 30B	Dark blue	80		
	911 551 011 04 50B	Beige	80		
	(5A)	911 551 011 04 80E	Burgundy		
911 551 011 46		Carpet	/RL /L		
		Velour pile	-78		
911 551 011 46 8AB		Lobster			
911 551 011 46 5AZ		Cork			
	911 551 011 46 7AZ	Black			

Model: 911 78 Model life 1978>>1983

Pos	Part Number	Description	Remark	Qty	Model		
(5A)	911 551 011 46 20B	Dark green		1	TARGA/CABRIO M399/559		
	911 551 011 46 40A	Brown					
	911 551 011 46 8AZ	Light red					
	911 551 011 46 1AY	Yellow					
	911 551 011 48	Carpet	/RL /L				
		Velour pile	-78				
(5A)	911 551 011 48 8AB	Lobster		1	TARGA/CABRIO		
	911 551 011 48 5AZ	Cork					
	911 551 011 48 7AZ	Black					
	911 551 011 48 20B	Dark green					
	911 551 011 48 40A	Brown					
	911 551 011 48 8AZ	Light red					
	911 551 011 48 1AY	Yellow					
	911 551 011 46	Carpet	/RL /L				
		Cut pile	79-				
	911 551 011 46 5AF	Cork					
	911 551 011 46 70E	Black					
	911 551 011 46 2AF	Dark green					
	911 551 011 46 40E	Brown					
	911 551 011 46 8AF	Light red					
	911 551 011 46 1AF	Yellow					
911 551 011 46 30B	Dark blue	80-					
911 551 011 46 50B	Beige	80-					
911 551 011 46 20S	Mint green	81-					
911 551 011 46 80E	Burgundy						
911 551 011 46 60A	Grey	83-					
911 551 011 46 2FL	Grey-beige	83-					
911 551 011 46 6JD	Dark green	83-					
911 551 011 46 80S	Can-can-red	83-					
911 551 011 46 1VD	Champagne	83-					
(5A)	911 551 011 48	Carpet	/RL /L	1	TARGA/CABRIO M399/559		
		Cut pile	79-				
911 551 011 48 5AF	Cork						
911 551 011 48 70E	Black						
911 551 011 48 2AF	Dark green						
911 551 011 48 40E	Brown						
911 551 011 48 8AF	Light red						
911 551 011 48 1AF	Yellow						
911 551 011 48 30B	Dark blue	80-					
911 551 011 48 50B	Beige	80-					
911 551 011 48 20S	Mint green	81-					
911 551 011 48 80E	Burgundy						
911 551 011 48 60A	Grey	83-					
911 551 011 48 2FL	Grey-beige	83-					
911 551 011 48 6JD	Dark green	83-					
911 551 011 48 80S	Can-can-red	83-					
911 551 011 48 1VD	Champagne	83-					
(5A)	911 551 011 44	Carpet	/RL /L	1	TARGA:SPM		
		Velour pile	-78				
911 551 011 44 8AB	Lobster						
911 551 011 44 5AZ	Cork						
911 551 011 44 7AZ	Black						
911 551 011 44 20B	Dark green						
911 551 011 44 40A	Brown						
911 551 011 44 8AZ	Light red						
911 551 011 44 1AY	Yellow						
(5A)	911 551 011 44	Carpet	/RL /L			1	TARGA:SPM
		Cut pile	79-				
911 551 011 44 5AF	Cork						
911 551 011 44 70E	Black						
911 551 011 44 2AF	Dark green						

Model: 911 78 Model life 1978>>1983

Pos	Part Number	Description	Remark	Qty	Model
	911 551 011 44 40E	Brown			
	911 551 011 44 8AF	Light red			
	911 551 011 44 1AF	Yellow			
	911 551 011 44 30B	Dark blue	80		
	911 551 011 44 50B	Beige	80		
	911 551 011 44 80E	Burgundy			
6	911 551 015 02	Floorboard carpet Velour pile	/LL /L -78	1	COUPE
	911 551 015 02 8AB	Lobster			
	911 551 015 02 5AZ	Cork			
	911 551 015 02 7AZ	Black			
	911 551 015 02 20B	Dark green			
	911 551 015 02 40A	Brown			
	911 551 015 02 8AZ	Light red			
	911 551 015 02 1AY	Yellow			
(6)	911 551 016 08	Floorboard carpet Velour pile	/RL /R -78	1	
	911 551 016 08 8AB	Lobster			
	911 551 016 08 5AZ	Cork			
	911 551 016 08 7AZ	Black			
	911 551 016 08 20B	Dark green			
	911 551 016 08 40A	Brown			
	911 551 016 08 8AZ	Light red			
	911 551 016 08 1AY	Yellow			
6	911 551 015 02	Floorboard carpet Cut pile	/LL /L 79-	1	COUPE
	911 551 015 02 5AF	Cork			
	911 551 015 02 70E	Black			
	911 551 015 02 2AF	Dark green			
	911 551 015 02 40E	Brown			
	911 551 015 02 8AF	Light red			
	911 551 015 02 1AF	Yellow			
	911 551 015 02 30B	Blue	80-		
	911 551 015 02 50B	Beige	80-		
	911 551 015 02 20S	Mint green	81-		
	911 551 015 02 8AY	Russet	80		
	911 551 015 02 80E	Burgundy			
	911 551 015 02 60A	Grey	83-		
	911 551 015 02 2FL	Grey-beige	83-		
	911 551 015 02 6JD	Dark green	83-		
	911 551 015 02 80S	Can-can-red	83-		
	911 551 015 02 1VD	Champagne	83-		
(6)	911 551 016 08	Floorboard carpet Cut pile	/RL /R 79-	1	
	911 551 016 08 5AF	Cork			
	911 551 016 08 70E	Black			
	911 551 016 08 2AF	Dark green			
	911 551 016 08 40E	Brown			
	911 551 016 08 8AF	Light red			
	911 551 016 08 1AF	Yellow			
	911 551 016 08 30B	Blue	80-		
	911 551 016 08 50B	Beige	80-		
	911 551 016 08 20S	Mint green	81-		
	911 551 016 08 8AY	Russet	80		
	911 551 016 08 80E	Burgundy			
	911 551 016 08 60A	Grey	83-		
	911 551 016 08 2FL	Grey-beige	83-		
	911 551 016 08 6JD	Dark green	83-		
	911 551 016 08 80S	Can-can-red	83-		
	911 551 016 08 1VD	Champagne	83-		
(6)	911 551 015 42	Floorboard carpet Velour pile	/LL /L -78	1	TARGA/CABRIO
	911 551 015 42 8AB	Lobster			

Model: 911 78 Model life 1978>>1983

Pos	Part Number	Description	Remark	Qty	Model
(6)	911 551 015 42 5AZ	Cork			
	911 551 015 42 7AZ	Black			
	911 551 015 42 20B	Dark green			
	911 551 015 42 40A	Brown			
	911 551 015 42 8AZ	Light red			
	911 551 015 42 1AY	Yellow			
	911 551 015 42	Floorboard carpet Cut pile	/LL /L 79-	1	TARGA/CABRIO
	911 551 015 42 5AF	Cork			
	911 551 015 42 70E	Black			
	911 551 015 42 2AF	Dark green			
	911 551 015 42 40E	Brown			
	911 551 015 42 8AF	Light red			
	911 551 015 42 1AF	Yellow			
	911 551 015 42 30B	Blue	80-		
	911 551 015 42 50B	Beige	80-		
	911 551 015 42 20S	Mint green	81-		
911 551 015 42 80E	Burgundy				
911 551 015 42 60A	Grey	83-			
911 551 015 42 2FL	Grey-beige	83-			
911 551 015 42 6JD	Dark green	83-			
911 551 015 42 80S	Can-can-red	83-			
911 551 015 42 1VD	Champagne	83-			
7	911 551 015 06	Floorboard carpet Velour pile	/LL /L -79 -78	1	SPM
(7)	911 551 015 06 8AB	Lobster			
	911 551 015 06 5AZ	Cork			
	911 551 015 06 7AZ	Black			
	911 551 015 06 20B	Dark green			
	911 551 015 06 40A	Brown			
	911 551 015 06 8AZ	Light red			
	911 551 015 06 1AY	Yellow			
	911 551 016 06	Floorboard carpet Velour pile	/RL /R -78	1	SPM
	911 551 016 06 8AB	Lobster			
	911 551 016 06 5AZ	Cork			
911 551 016 06 7AZ	Black				
911 551 016 06 20B	Dark green				
911 551 016 06 40A	Brown				
911 551 016 06 8AZ	Light red				
911 551 016 06 1AY	Yellow				
(7)	911 551 016 07	Floorboard carpet Velour pile	/RL /R -78	1	M399/559
7	911 551 016 07 8AB	Lobster			
	911 551 016 07 5AZ	Cork			
	911 551 016 07 7AZ	Black			
	911 551 016 07 20B	Dark green			
	911 551 016 07 40A	Brown			
	911 551 016 07 8AZ	Light red			
	911 551 016 07 1AY	Yellow			
	911 551 015 06	Floorboard carpet Cut pile	/LL /L 79-	1	SPM
	911 551 015 06 5AF	Cork			
	911 551 015 06 70E	Black			
	911 551 015 06 2AF	Dark green			
	911 551 015 06 40E	Brown			
	911 551 015 06 8AF	Light red			
	911 551 015 06 1AF	Yellow			
	911 551 015 06 30B	Dark blue	80-		
	911 551 015 06 50B	Beige	80-		
911 551 015 06 20S	Mint green	81-			
911 551 015 06 8AY	Russet				
911 551 015 06 80E	Burgundy				

Model: 911 78 Model life 1978>>1983

Pos	Part Number	Description	Remark	Qty	Model
(7)	911 551 016 06	Floorboard carpet Cut pile	/RL /R 79-	1	SPM
	911 551 016 06 5AF	Cork			
	911 551 016 06 70E	Black			
	911 551 016 06 2AF	Dark green			
	911 551 016 06 40E	Brown			
	911 551 016 06 8AF	Light red			
	911 551 016 06 1AF	Yellow			
	911 551 016 06 30B	Dark blue	80-		
	911 551 016 06 50B	Beige	80-		
	911 551 016 06 20S	Mint green	81-		
	911 551 016 06 8AY	Russet	80		
	911 551 016 06 80E	Burgundy			
(7)	911 551 016 07	Floorboard carpet Cut pile	/RL /R 79-	1	M399/559
	911 551 016 07 5AF	Cork			
	911 551 016 07 70E	Black			
	911 551 016 07 2AF	Dark green			
	911 551 016 07 40E	Brown			
	911 551 016 07 8AF	Light red			
	911 551 016 07 1AF	Yellow			
	911 551 016 07 30B	Dark blue	80-		
	911 551 016 07 50B	Beige	80-		
	911 551 016 07 20S	Mint green	81-		
	911 551 016 07 8AY	Russet	80		
	911 551 016 07 80E	Burgundy			
8	911 551 012 10	Carpet Velour pile	/LL /R -78	1	COUPE
	911 551 012 10 8AB	Lobster			
	911 551 012 10 5AZ	Cork			
	911 551 012 10 7AZ	Black			
	911 551 012 10 20B	Dark green			
	911 551 012 10 40A	Brown			
	911 551 012 10 8AZ	Light red			
	911 551 012 10 1AY	Yellow			
8	911 551 012 10	Carpet Cut pile	/LL /R 79	1	COUPE
	911 551 012 10 5AF	Cork			
	911 551 012 10 70E	Black			
	911 551 012 10 2AF	Dark green			
	911 551 012 10 40E	Brown			
	911 551 012 10 8AF	Light red			
	911 551 012 10 1AF	Yellow			
8	911 551 012 14	Carpet Cut pile	/LL /R 80-	1	COUPE
	911 551 012 14 5AF	Cork			
	911 551 012 14 70E	Black			
	911 551 012 14 2AF	Dark green			
	911 551 012 14 40E	Brown			
	911 551 012 14 8AF	Light red			
	911 551 012 14 1AF	Yellow			
	911 551 012 14 30B	Dark blue			
	911 551 012 14 50B	Beige			
	911 551 012 14 20S	Mint green	81-		
	911 551 012 14 8AY	Russet	80		
	911 551 012 14 80E	Burgundy			
	911 551 012 14 60A	Grey	83-		
	911 551 012 14 2FL	Grey-beige	83-		
	911 551 012 14 6JD	Dark green	83-		
	911 551 012 14 80S	Can-can-red	83-		
	911 551 012 14 1VD	Champagne	83-		
(8)	911 551 022 00	Carpet	/RL /R	1	COUPE M399/559

Model: 911 78 Model life 1978>>1983

Pos	Part Number	Description	Remark	Qty	Model
		Velour pile	-79		
	911 551 022 00 8AB	Lobster			
	911 551 022 00 5AZ	Cork			
	911 551 022 00 7AZ	Black			
	911 551 022 00 20B	Dark green			
	911 551 022 00 40A	Brown			
	911 551 022 00 8AZ	Light red			
	911 551 022 00 1AY	Yellow			
(8)	911 551 022 00	Carpet	/RL /R	1	COUPE M399/559
		Cut pile	79-		
	911 551 022 00 5AF	Cork			
	911 551 022 00 70E	Black			
	911 551 022 00 2AF	Dark green			
	911 551 022 00 40E	Brown			
	911 551 022 00 8AF	Light red			
	911 551 022 00 1AF	Yellow			
	911 551 022 00 30B	Dark blue	80-		
	911 551 022 00 50B	Beige	80-		
	911 551 022 00 20S	Mint green	81-		
	911 551 022 00 80E	Burgundy			
	911 551 022 00 60A	Grey	83-		
	911 551 022 00 2FL	Grey-beige	83-		
	911 551 022 00 6JD	Dark green	83-		
	911 551 022 00 80S	Can-can-red	83-		
	911 551 022 00 1VD	Champagne	83-		
(8)	911 551 022 01	Carpet	/RL /R	1	COUPE:SPM M399/559
		Velour pile	-78		
	911 551 022 01 8AB	Lobster			
	911 551 022 01 5AZ	Cork			
	911 551 022 01 7AZ	Black			
	911 551 022 01 20B	Dark green			
	911 551 022 01 40A	Brown			
	911 551 022 01 8AZ	Light red			
	911 551 022 01 1AY	Yellow			
(8)	911 551 022 01	Carpet	/RL /R	1	COUPE:SPM M399/559
		Cut pile	79-		
	911 551 022 01 5AF	Cork			
	911 551 022 01 70E	Black			
	911 551 022 01 2AF	Dark green			
	911 551 022 01 40E	Brown			
	911 551 022 01 8AF	Light red			
	911 551 022 01 1AF	Yellow			
	911 551 022 01 30B	Dark blue	80		
	911 551 022 01 50B	Beige	80		
	911 551 022 01 80E	Burgundy			
(8)	911 551 012 11	Carpet	/LL /R	1	COUPE M399/559
		Velour pile	-78		
	911 551 012 11 8AB	Lobster			
	911 551 012 11 5AZ	Cork			
	911 551 012 11 7AZ	Black			
	911 551 012 11 20B	Dark green			
	911 551 012 11 40A	Brown			
	911 551 012 11 8AZ	Light red			
	911 551 012 11 1AY	Yellow			
(8)	911 551 012 11	Carpet	/LL /R	1	COUPE M399/559
		Cut pile	79-		
	911 551 012 11 5AF	Cork			
	911 551 012 11 70E	Black			

Model: 911 78 Model life 1978>>1983

Pos	Part Number	Description	Remark	Qty	Model			
8	911 551 012 11 2AF	Dark green		1	COUPE M559			
	911 551 012 11 40E	Brown						
	911 551 012 11 8AF	Light red						
	911 551 012 11 1AF	Yellow						
	911 551 012 15	Carpet	/LL /R					
		Cut pile	80-					
	911 551 012 15 5AF	Cork						
	911 551 012 15 70E	Black						
	911 551 012 15 2AF	Dark green						
	911 551 012 15 40E	Brown						
	911 551 012 15 8AF	Light red						
	911 551 012 15 1AF	Yellow						
	911 551 012 15 30B	Dark blue						
	911 551 012 15 50B	Beige						
	911 551 012 15 20S	Mint green	81-					
(8)	911 551 012 15 80E	Burgundy		1	TARGA/CABRIO			
	911 551 012 15 60A	Grey	83-					
	911 551 012 15 2FL	Grey-beige	83-					
	911 551 012 15 6JD	Dark green	83-					
	911 551 012 15 80S	Can-can-red	83-					
	911 551 012 15 1VD	Champagne	83-					
	911 551 022 40	Carpet	/RL /R					
		Velour pile	-78					
	911 551 022 40 8AB	Lobster						
	911 551 022 40 5AZ	Cork						
	911 551 022 40 7AZ	Black						
	911 551 022 40 20B	Dark green						
	911 551 022 40 40A	Brown						
	911 551 022 40 8AZ	Light red						
	911 551 022 40 1AY	Yellow						
(8)	911 551 022 41	Carpet	/RL /R	1	TARGA M559			
		Velour pile	-78					
	911 551 022 41 8AB	Lobster						
	911 551 022 41 5AZ	Cork						
	911 551 022 41 7AZ	Black						
	911 551 022 41 20B	Dark green						
	911 551 022 41 40A	Brown						
	911 551 022 41 8AZ	Light red						
	911 551 022 41 1AY	Yellow						
	(8)	911 551 012 50	Carpet			/LL /R	1	TARGA:SPM M399/559
			Velour pile			-78		
		911 551 012 50 8AB	Lobster					
		911 551 012 50 5AZ	Cork					
		911 551 012 50 7AZ	Black					
		911 551 012 50 20B	Dark green					
911 551 012 50 40A		Brown						
911 551 012 50 8AZ		Light red						
911 551 012 50 1AY		Yellow						
(8)		911 551 022 40	Carpet	/RL /R	1	TARGA/CABRIO		
			Cut pile	79-				
		911 551 022 40 5AF	Cork					
		911 551 022 40 70E	Black					
		911 551 022 40 2AF	Dark green					
		911 551 022 40 40E	Brown					
	911 551 022 40 8AF	Light red						
	911 551 022 40 1AF	Yellow						
	911 551 022 40 30B	Dark blue						
	911 551 022 40 50B	Beige						
	911 551 022 40 20S	Mint green	81-					
	911 551 022 40 80E	Burgundy						

Model: 911 78 Model life 1978>>1983

Pos	Part Number	Description	Remark	Qty	Model
(8)	911 551 022 40 60A	Grey	83-	1	TARGA M559
	911 551 022 40 2FL	Grey-beige	83-		
	911 551 022 40 6JD	Dark green	83-		
	911 551 022 40 80S	Can-can-red	83-		
	911 551 022 40 1VD	Champagne	83-		
	911 551 022 41	Carpet	/RL /R		
		Cut pile	79-		
	911 551 022 41 5AF	Cork			
	911 551 022 41 70E	Black			
	911 551 022 41 2AF	Dark green			
	911 551 022 41 40E	Brown			
	911 551 022 41 8AF	Light red			
	911 551 022 41 1AF	Yellow			
	911 551 022 41 30B	Dark blue			
	911 551 022 41 50B	Beige			
	911 551 022 41 20S	Mint green	81-		
	(8)	911 551 022 41 80E	Burgundy		
911 551 022 41 60A		Grey	83-		
911 551 022 41 2FL		Grey-beige	83-		
911 551 022 41 6JD		Dark green	83-		
911 551 022 41 80S		Can-can-red	83-		
911 551 022 41 1VD		Champagne	83-		
911 551 012 50		Carpet	/LL /R		
		Cut pile	79-		
911 551 012 50 5AF		Cork			
911 551 012 50 70E		Black			
911 551 012 50 2AF		Dark green			
911 551 012 50 40E		Brown			
911 551 012 50 8AF		Light red			
911 551 012 50 1AF		Yellow			
911 551 012 50 30B		Dark blue			
911 551 012 50 50B		Beige			
911 551 012 50 20S		Mint green	81-		
(8)	911 551 012 50 80E	Burgundy		1	TARGA
	911 551 012 50 60A	Grey	83-		
	911 551 012 50 2FL	Grey-beige	83-		
	911 551 012 50 6JD	Dark green	83-		
	911 551 012 50 80S	Can-can-red	83-		
	911 551 012 50 1VD	Champagne	83-		
	911 551 012 49	Carpet	/LL /R		
		Velour pile	-78		
	911 551 012 49 8AB	Lobster			
	911 551 012 49 5AZ	Cork			
	911 551 012 49 7AZ	Black			
	911 551 012 49 20B	Dark green			
	911 551 012 49 40A	Brown			
	911 551 012 49 8AZ	Light red			
	911 551 012 49 1AY	Yellow			
	911 551 012 49	Carpet	/LL /R		
		Cut pile	79		
(8)	911 551 012 49 5AF	Cork		1	TARGA/CABRIO
	911 551 012 49 70E	Black			
	911 551 012 49 2AF	Dark green			
	911 551 012 49 40E	Brown			
	911 551 012 49 8AF	Light red			
	911 551 012 49 1AF	Yellow			
	911 551 012 49 80E	Burgundy			
	911 551 012 53	Carpet	/LL /R		
		Cut pile	80-		
	911 551 012 53 5AF	Cork			
	911 551 012 53 70E	Black			

Model: 911 78 Model life 1978>>1983

Pos	Part Number	Description	Remark	Qty	Model
	911 551 012 53 2AF	Dark green			
	911 551 012 53 40E	Brown			
	911 551 012 53 8AF	Light red			
	911 551 012 53 1AF	Yellow			
	911 551 012 53 30B	Dark blue			
	911 551 012 53 50B	Beige			
	911 551 012 53 20S	Mint green	81-		
	911 551 012 53 8AY	Russet	80		
	911 551 012 53 80E	Burgundy			
	911 551 012 53 60A	Grey	83-		
	911 551 012 53 2FL	Grey-beige	83-		
	911 551 012 53 6JD	Dark green	83-		
	911 551 012 53 80S	Can-can-red	83-		
	911 551 012 53 1VD	Champagne	83-		
(8)	911 551 012 54	Carpet	/LL /R	1	TARGA CABRIO M559
		Cut pile	80-		
	911 551 012 54 5AF	Cork			
	911 551 012 54 70E	Black			
	911 551 012 54 2AF	Dark green			
	911 551 012 54 40E	Brown			
	911 551 012 54 8AF	Light red			
	911 551 012 54 1AF	Yellow			
	911 551 012 54 30B	Dark blue			
	911 551 012 54 50B	Beige			
	911 551 012 54 20S	Mint green	81-		
	911 551 012 54 8AY	Russet	80		
	911 551 012 54 80E	Burgundy			
	911 551 012 54 60A	Grey	83-		
	911 551 012 54 2FL	Grey-beige	83-		
	911 551 012 54 6JD	Dark green	83-		
	911 551 012 54 80S	Can-can-red	83-		
	911 551 012 54 1VD	Champagne	83-		
(8)	911 551 912 00	Floor mat with Logo 911	/R	1	
	911 551 912 00 4KD	Brown			
	911 551 912 00 7KD	Black			
	911 551 912 00 3KD	Blue			
9	911 551 014 04	Carpet	/H /R -79	1	
		Velour pile	-78		
	911 551 014 04 8AB	Lobster			
	911 551 014 04 5AZ	Cork			
	911 551 014 04 7AZ	Black			
	911 551 014 04 20B	Dark green			
	911 551 014 04 40A	Brown			
	911 551 014 04 8AZ	Light red			
	911 551 014 04 1AY	Yellow			
(9)	911 551 014 05	Carpet	/H /R 80-	1	
		Velour pile	-78		
	911 551 014 05 8AB	Lobster			
	911 551 014 05 5AZ	Cork			
	911 551 014 05 7AZ	Black			
	911 551 014 05 20B	Dark green			
	911 551 014 05 40A	Brown			
	911 551 014 05 8AZ	Light red			
	911 551 014 05 1AY	Yellow			
9	911 551 014 04	Carpet	/H /R	1	
		Cut pile	79-		
	911 551 014 04 5AF	Cork			
	911 551 014 04 70E	Black			

Model: 911 78 Model life 1978>>1983

Pos	Part Number	Description	Remark	Qty	Model
	911 551 014 04 2AF	Dark green			
	911 551 014 04 40E	Brown			
	911 551 014 04 8AF	Light red			
	911 551 014 04 1AF	Yellow			
	911 551 014 04 30B	Dark blue	80-		
	911 551 014 04 50B	Beige	80-		
	911 551 014 04 20S	Mint green	81-		
	911 551 014 04 8AY	Russet			
	911 551 014 04 80E	Burgundy			
	911 551 014 04 60A	Grey	83-		
	911 551 014 04 2FL	Grey-beige	83-		
	911 551 014 04 6JD	Dark green	83-		
	911 551 014 04 80S	Can-can-red	83-		
	911 551 014 04 1VD	Champagne	83-		
(9)	911 551 014 05	Carpet	/H /R 80-	1	
		Cut pile	79-		
	911 551 014 05 5AF	Cork			
	911 551 014 05 70E	Black			
	911 551 014 05 2AF	Dark green			
	911 551 014 05 40E	Brown			
	911 551 014 05 8AF	Light red			
	911 551 014 05 1AF	Yellow			
	911 551 014 05 30B	Dark blue	80-		
	911 551 014 05 50B	Beige	80-		
	911 551 014 05 20S	Mint green	81-		
	911 551 014 05 8AY	Russet	80		
	911 551 014 05 80E	Burgundy			
	911 551 014 05 60A	Grey	83-		
	911 551 014 05 2FL	Grey-beige	83-		
	911 551 014 05 6JD	Dark green	83-		
	911 551 014 05 80S	Can-can-red	83-		
	911 551 014 05 1VD	Champagne	83-		
10	911 551 013 03	Carpet	/H /L	1	
		Velour pile	-78		
	911 551 013 03 8AB	Lobster			
	911 551 013 03 5AZ	Cork			
	911 551 013 03 7AZ	Black			
	911 551 013 03 20B	Dark green			
	911 551 013 03 40A	Brown			
	911 551 013 03 8AZ	Light red			
	911 551 013 03 1AY	Yellow			
10	911 551 013 03	Carpet	/H /L	1	
		Cut pile	79-		
	911 551 013 03 5AF	Cork			
	911 551 013 03 70E	Black			
	911 551 013 03 2AF	Dark green			
	911 551 013 03 40E	Brown			
	911 551 013 03 8AF	Light red			
	911 551 013 03 1AF	Yellow			
	911 551 013 03 30B	Dark blue	80-		
	911 551 013 03 50B	Beige	80-		
	911 551 013 03 20S	Mint green	81-		
	911 551 013 03 8AY	Russet	80		
	911 551 013 03 80E	Burgundy			
	911 551 013 03 60A	Grey	83-		
	911 551 013 03 2FL	Grey-beige	83-		
	911 551 013 03 6JD	Dark green	83-		
	911 551 013 03 80S	Can-can-red	83-		
	911 551 013 03 1VD	Champagne	83-		
11	911 551 411 39	Carpet for tunnel		1	
		Velour pile	-78		
	911 551 411 39 8AB	Lobster			
	911 551 411 39 5AZ	Cork			

Model: 911 78 Model life 1978>>1983

Pos	Part Number	Description	Remark	Qty	Model
11	911 551 411 39 7AZ	Black		1	
	911 551 411 39 20B	Dark green			
	911 551 411 39 40A	Brown			
	911 551 411 39 8AZ	Light red			
	911 551 411 39 1AY	Yellow			
	911 551 411 39	Carpet for tunnel Cut pile	79-		
	911 551 411 39 5AF	Cork			
	911 551 411 39 70E	Black			
	911 551 411 39 2AF	Dark green			
	911 551 411 39 40E	Brown			
	911 551 411 39 8AF	Light red			
	911 551 411 39 1AF	Yellow			
	911 551 411 39 30B	Dark blue	80-		
	911 551 411 39 50B	Beige	80-		
	911 551 411 39 20S	Mint green	81-		
	911 551 411 39 8AY	Russet	80		
	911 551 411 39 80E	Burgundy			
	911 551 411 39 60A	Grey	83-		
	911 551 411 39 2FL	Grey-beige	83-		
	911 551 411 39 6JD	Dark green	83-		
911 551 411 39 80S	Can-can-red	83-			
911 551 411 39 1VD	Champagne	83-			
12	999 591 801 17	Push button for carpet		2	
13	999 591 805 12	Push button		2	
14	900 145 043 00	Rais. counters. h. tap. s. B 3,5 X 9,5		2	
15	911 551 063 04	Pedal floor board	/LL /L	1	COUPE
(15)	901 551 061 23	Pedal floor board	/RL /L	1	COUPE
-	911 551 017 04	Floorboard carpet Pedal floor board Velour pile	/RL /L -78	1	COUPE M399/559
	911 551 017 04 8AB	Lobster			
	911 551 017 04 5AZ	Cork			
	911 551 017 04 7AZ	Black			
	911 551 017 04 20B	Dark green			
	911 551 017 04 40A	Brown			
	911 551 017 04 8AZ	Red			
	911 551 017 04 1AY	Yellow			
-	911 551 017 04	Floorboard carpet Pedal floor board Cut pile	/RL /L 79-	1	COUPE M399/559
	911 551 017 04 5AF	Cork			
	911 551 017 04 70E	Black			
	911 551 017 04 2AF	Dark green			
	911 551 017 04 40E	Brown			
	911 551 017 04 8AF	Light red			
	911 551 017 04 1AF	Yellow			
	911 551 017 04 20S	Mint green	81-		
	911 551 017 04 30B	Dark blue	80-		
	911 551 017 04 50B	Beige	80-		
	911 551 017 04 80E	Burgundy			
(15)	911 551 063 03	Pedal floor board	/LL /L	1	COUPE:SPM
(15)	911 551 063 44	Pedal floor board	/LL /L	1	TARGA/CABRIO
(15)	911 551 063 42	Pedal floor board	/LL /L	1	TARGA:SPM
(15)	901 551 061 42	Pedal floor board	/RL /L	1	TARGA
(15)	911 551 075 41	Floorboard	/RL /L /399	1	TARGA CABRIO M559
16	901 551 064 22	Pedal floor board	/LL /R	1	COUPE
(16)	905 551 062 26	Pedal floor board	/RL /R	1	COUPE:SPM
(16)	911 551 062 22	Pedal floor board	/RL /R	1	COUPE
(16)	911 551 075 01	Floorboard	/RL /L	1	COUPE

Model: 911 78 Model life 1978>>1983

Pos	Part Number	Description	Remark	Qty	Model
(16)	901 551 064 42	Pedal floor board	/LL /R	1	M399/559 TARGA/CABRIO
(16)	911 551 062 42	Pedal floor board	/RL /R -79	1	TARGA
(16)		Pedal floor board	/RL /R 80-	1	TARGA/CABRIO
(16)	905 551 062 44	Pedal floor board	/RL /R -79	1	TARGA:SPM
(16)		Pedal floor board	/RL /R 80-	1	TARGA:SPM
-	900 119 025 02	Pan-head screw M 5 X 15	/RL	1	M399/559 COUPE
-	901 423 368 00	Desk pad	/RL	1	COUPE M399/559
17	N 042 121 3	Shake-proof washer A 6,4		1	COUPE
18	900 076 010 02	Nut M 6		1	COUPE
18	900 076 010 0B	Nut M 6		1	COUPE
19	901 501 950 22	Foot support	/RL	1	COUPE
(19)	911 501 950 02	Foot support	/RL	1	COUPE M399/559
(19)	911 501 950 03	Foot support	/RL	1	TARGA/CABRIO M399/559
20	N 015 429 2	Speed nut B 4,2	/RL	2	
20	N 015 429 6	Speed nut B 4,2	/RL	2	
21	900 145 035 02	Rais. counters. h. tap. s. B 4,2 X 16	/RL	2	
22	901 501 958 22	Desk pad	/RL	2	
23	911 551 042 05	Carpet Wheel housing Velour pile	/LL /R -78	1	
	911 551 042 05 8AB	Lobster			
	911 551 042 05 5AZ	Cork			
	911 551 042 05 7AZ	Black			
	911 551 042 05 20B	Dark green			
	911 551 042 05 40A	Brown			
	911 551 042 05 8AZ	Light red			
	911 551 042 05 1AY	Yellow			
23	911 551 042 06	Carpet Wheel housing Velour pile	/RL /R -78	1	
	911 551 042 06 8AB	Lobster			
	911 551 042 06 5AZ	Cork			
	911 551 042 06 7AZ	Black			
	911 551 042 06 20B	Dark green			
	911 551 042 06 40A	Brown			
	911 551 042 06 8AZ	Light red			
	911 551 042 06 1AY	Yellow			
(23)	911 551 041 03	Carpet Wheel housing Velour pile	/L -78	1	
	911 551 041 03 8AB	Lobster			
	911 551 041 03 5AZ	Cork			
	911 551 041 03 7AZ	Black			
	911 551 041 03 20B	Dark green			
	911 551 041 03 40A	Brown			
	911 551 041 03 8AZ	Light red			
	911 551 041 03 1AY	Yellow			
23	911 551 042 05	Carpet Cut pile	/LL /R 79-	1	
	911 551 042 05 5AF	Cork			
	911 551 042 05 70E	Black			

Model: 911 78 Model life 1978>>1983

Pos	Part Number	Description	Remark	Qty	Model
	911 551 042 05 2AF	Dark green			
	911 551 042 05 40E	Brown			
	911 551 042 05 8AF	Light red			
	911 551 042 05 1AF	Yellow			
	911 551 042 05 30B	Dark blue	80-		
	911 551 042 05 50B	Beige	80-		
	911 551 042 05 20S	Mint green	81-		
	911 551 042 05 8AY	Russet	80		
	911 551 042 05 80E	Burgundy			
	911 551 042 05 60A	Grey	83-		
	911 551 042 05 2FL	Grey-beige	83-		
	911 551 042 05 6JD	Dark green	83-		
	911 551 042 05 80S	Can-can-red	83-		
	911 551 042 05 1VD	Champagne	83-		
23	911 551 042 06	Carpet	/RL /R	1	
		Cut pile	79-		
	911 551 042 06 5AF	Cork			
	911 551 042 06 70E	Black			
	911 551 042 06 2AF	Dark green			
	911 551 042 06 40E	Brown			
	911 551 042 06 8AF	Light red			
	911 551 042 06 1AF	Yellow			
	911 551 042 06 30B	Dark blue	80-		
	911 551 042 06 50B	Beige	80-		
	911 551 042 06 20S	Mint green	81-		
	911 551 042 06 8AY	Russet	80		
	911 551 042 06 80E	Burgundy			
	911 551 042 06 60A	Grey	83-		
	911 551 042 06 2FL	Grey-beige	83-		
	911 551 042 06 6JD	Dark green	83-		
	911 551 042 06 80S	Can-can-red	83-		
	911 551 042 06 1VD	Champagne	83-		
(23)	911 551 041 03	Carpet	/L	1	
		Cut pile	79-		
	911 551 041 03 5AF	Cork			
	911 551 041 03 70E	Black			
	911 551 041 03 2AF	Dark green			
	911 551 041 03 40E	Brown			
	911 551 041 03 8AF	Light red			
	911 551 041 03 1AF	Yellow			
	911 551 041 03 30B	Dark blue	80-		
	911 551 041 03 50B	Beige	80-		
	911 551 041 03 20S	Mint green	81-		
	911 551 041 03 8AY	Russet	80		
	911 551 041 03 80E	Burgundy			
	911 551 041 03 60A	Grey	83-		
	911 551 041 03 2FL	Grey-beige	83-		
	911 551 041 03 6JD	Dark green	83-		
	911 551 041 03 80S	Can-can-red	83-		
	911 551 041 03 1VD	Champagne	83-		
24	911 551 032 50	Carpet	/R	1	
		Velour pile	-78		
	911 551 032 50 8AB	Lobster			
	911 551 032 50 5AZ	Cork			
	911 551 032 50 7AZ	Black			
	911 551 032 50 20B	Dark green			
	911 551 032 50 40A	Brown			
	911 551 032 50 8AZ	Light red			
	911 551 032 50 1AY	Yellow			
(24)	911 551 031 50	Carpet	/L	1	
		Velour pile	-78		
	911 551 031 50 8AB	Lobster			
	911 551 031 50 5AZ	Cork			

Model: 911 78 Model life 1978>>1983

Pos	Part Number	Description	Remark	Qty	Model
24	911 551 031 50 7AZ	Black		1	
	911 551 031 50 20B	Dark green			
	911 551 031 50 40A	Brown			
	911 551 031 50 8AZ	Light red			
	911 551 031 50 1AY	Yellow			
	911 551 032 50	Carpet	/R		
		Cut pile	79-		
	911 551 032 50 5AF	Cork			
	911 551 032 50 70E	Black			
	911 551 032 50 2AF	Dark green			
	911 551 032 50 40E	Brown			
	911 551 032 50 8AF	Light red			
	911 551 032 50 1AF	Yellow			
	911 551 032 50 30B	Dark blue	80-		
	911 551 032 50 50B	Beige	80-		
	911 551 032 50 20S	Mint green	81-		
	911 551 032 50 8AY	Russet	80		
	911 551 032 50 80E	Burgundy			
	911 551 032 50 60A	Grey	83-		
	911 551 032 50 2FL	Grey-beige	83-		
	911 551 032 50 6JD	Dark green	83-		
	911 551 032 50 80S	Can-can-red	83-		
	911 551 032 50 1VD	Champagne	83-		
	(24) 911 551 031 50	Carpet	/L		
	Cut pile	79-			
911 551 031 50 5AF	Cork				
911 551 031 50 70E	Black				
911 551 031 50 2AF	Dark green				
911 551 031 50 40E	Brown				
911 551 031 50 8AF	Light red				
911 551 031 50 1AF	Yellow				
911 551 031 50 30B	Dark blue	80-			
911 551 031 50 50B	Beige	80-			
911 551 031 50 20S	Mint green	81-			
911 551 031 50 8AY	Russet	80			
911 551 031 50 80E	Burgundy				
911 551 031 50 60A	Grey	83-			
911 551 031 50 2FL	Grey-beige	83-			
911 551 031 50 6JD	Dark green	83-			
911 551 031 50 80S	Can-can-red	83-			
911 551 031 50 1VD	Champagne	83-			
25 911 551 034 02	Carpet	/R			
	Velour pile	-78			
911 551 034 02 8AB	Lobster				
911 551 034 02 5AZ	Cork				
911 551 034 02 7AZ	Black				
911 551 034 02 20B	Dark green				
911 551 034 02 40A	Brown				
911 551 034 02 8AZ	Light red				
911 551 034 02 1AY	Yellow				
(25) 911 551 033 02	Carpet	/L			
	Velour pile	-78			
911 551 033 02 8AB	Lobster				
911 551 033 02 5AZ	Cork				
911 551 033 02 7AZ	Black				
911 551 033 02 20B	Dark green				
911 551 033 02 40A	Brown				
911 551 033 02 8AZ	Light red				
911 551 033 02 1AY	Yellow				
25 911 551 034 02	Carpet	/R			
	Cut pile	79-			
911 551 034 02 5AF	Cork				
911 551 034 02 70E	Black				

Model: 911 78 Model life 1978>>1983

Pos	Part Number	Description	Remark	Qty	Model
	911 551 034 02 2AF	Dark green			
	911 551 034 02 40E	Brown			
	911 551 034 02 8AF	Light red			
	911 551 034 02 1AF	Yellow			
	911 551 034 02 30B	Dark blue	80-		
	911 551 034 02 50B	Beige	80-		
	911 551 034 02 20S	Mint green	81-		
	911 551 034 02 8AY	Russet	80		
	911 551 034 02 80E	Burgundy			
	911 551 034 02 60A	Grey	83-		
	911 551 034 02 2FL	Grey-beige	83-		
	911 551 034 02 6JD	Dark green	83-		
	911 551 034 02 80S	Can-can-red	83-		
	911 551 034 02 1VD	Champagne	83-		
(25)	911 551 033 02	Carpet	/L	1	
		Cut pile	79-		
	911 551 033 02 5AF	Cork			
	911 551 033 02 70E	Black			
	911 551 033 02 2AF	Dark green			
	911 551 033 02 40E	Brown			
	911 551 033 02 8AF	Light red			
	911 551 033 02 1AF	Yellow			
	911 551 033 02 30B	Dark blue	80-		
	911 551 033 02 50B	Beige	80-		
	911 551 033 02 20S	Mint green	81-		
	911 551 033 02 8AY	Russet	80		
	911 551 033 02 80E	Burgundy			
	911 551 033 02 60A	Grey	83-		
	911 551 033 02 2FL	Grey-beige	83-		
	911 551 033 02 6JD	Dark green	83-		
	911 551 033 02 80S	Can-can-red	83-		
	911 551 033 02 1VD	Champagne	83-		
(26)	901 551 115 20	Scuff plate	/L	1	
(26)	911 551 619 00	Rubber pad	/L	1	
26	901 551 116 20	Scuff plate	/R	1	
26	911 551 620 00	Rubber pad	/R	1	
27	901 551 419 50	Cover strip		2	
		Aluminium			
27	901 551 419 28	Cover strip		2	
		Black			
27		Cover strip		2	
		for			
		Door sill			
		Inner			
	901 551 419 28 70K	Black			
28	900 145 041 07	Tapping screw		10	
		Black			
		B 3,5 X 16			
28	900 145 041 00	Rais. counters. h. tap. s.		10	
		B 3,5 X 16			
29	911 551 067 03	Luggage compartment trim	/LL	1	
29	911 551 067 05	Luggage compartment trim	/LL	1	
(29)	911 551 068 01	Luggage compartment trim	/RL	1	
(29)	911 551 068 02	Luggage compartment trim	/RL	1	
(29)	911 551 068 01	Luggage compartment trim	/RL	1	
(29)	911 551 068 02	Luggage compartment trim	/RL	1	
30	900 075 260 02	Hexagon-head bolt		4	
		M 6 X 16			
31	N 012 007 2	Lock ring		4	
		A 6			
31	900 027 004 03	Lock ring		4	
		A 6			
32	900 151 003 02	Washer		4	

Model: 911 78

Model life 1978>>1983

Pos	Part Number	Description	Remark	Qty	Model
32	900 151 006 03	6,4 Washer 6,4		4	

Model: 911 78

Model life 1978>>1983

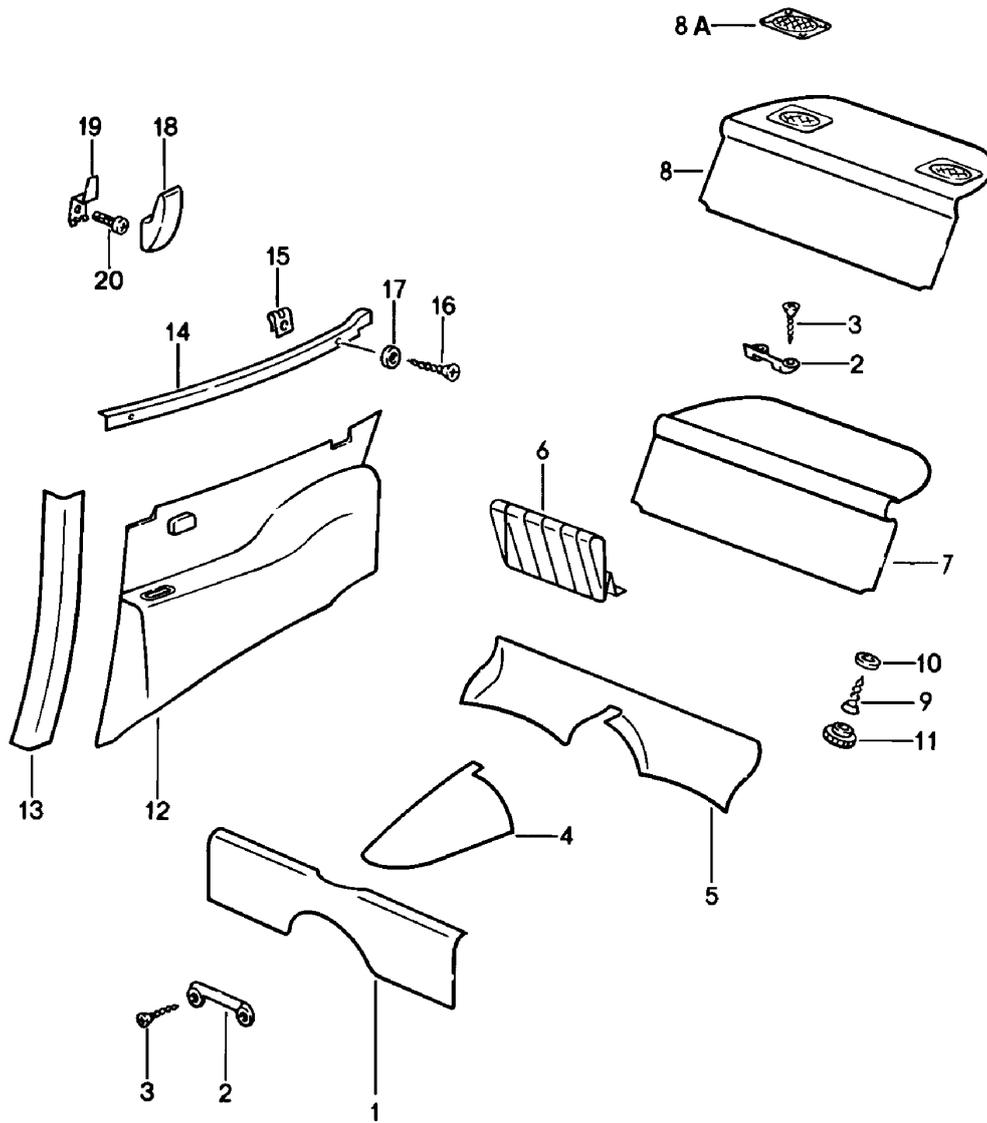

Model: 911 78 Model life 1978>>1983

Pos	Part Number	Description	Remark	Qty	Model
1	911 551 051 04	Interior equipment Rear Carpet Heel plate Velour pile	-78	1	
	911 551 051 04 8AB	Lobster			
	911 551 051 04 5AZ	Cork			
	911 551 051 04 7AZ	Black			
	911 551 051 04 20B	Dark green			
	911 551 051 04 40A	Brown			
	911 551 051 04 8AZ	Light red			
	911 551 051 04 1AY	Yellow			
1	911 551 051 04	Carpet Heel plate Cut pile	79-	1	
	911 551 051 04 5AF	Cork			
	911 551 051 04 70E	Black			
	911 551 051 04 2AF	Dark green			
	911 551 051 04 40E	Brown			
	911 551 051 04 8AF	Light red			
	911 551 051 04 1AF	Yellow			
	911 551 051 04 30B	Dark blue	80		
	911 551 051 04 50B	Beige	80		
	911 551 051 04 20S	Mint green	81-		
	911 551 051 04 8AY	Russet	80		
	911 551 051 04 80E	Burgundy			
	911 551 051 04 60A	Grey	83-		
	911 551 051 04 2FL	Grey-beige	83-		
	911 551 051 04 6JD	Dark green	83-		
	911 551 051 04 80S	Can-can-red	83-		
	911 551 051 04 1VD	Champagne	83-		
2	477 885 761	Retaining bar	-79	4	
3	900 270 049 07	Countersunk-head screw AM 5 X 20	-79	8	
4	911 551 023 00	Adhesive carpet Seat well Centre Velour pile	-78	1	
	911 551 023 00 8AB	Lobster			
	911 551 023 00 5AZ	Cork			
	911 551 023 00 7AZ	Black			
	911 551 023 00 20B	Dark green			
	911 551 023 00 40A	Brown			
	911 551 023 00 8AZ	Light red			
	911 551 023 00 1AY	Yellow			
4	911 551 023 00	Adhesive carpet Seat well Centre Cut pile	79-	1	
	911 551 023 00 5AF	Cork			
	911 551 023 00 70E	Black			
	911 551 023 00 2AF	Dark green	-82		
	911 551 023 00 40E	Brown			
	911 551 023 00 8AF	Light red			
	911 551 023 00 1AF	Yellow			
	911 551 023 00 30B	Dark blue	80-		
	911 551 023 00 50B	Beige	81-		
	911 551 023 00 20S	Mint green	80-		
	911 551 023 00 8AY	Russet	80		
	911 551 023 00 80E	Burgundy			
	911 551 023 00 60A	Grey	83-		
	911 551 023 00 2FL	Grey-beige	83-		
	911 551 023 00 6JD	Dark green	83-		

Model: 911 78 Model life 1978>>1983

Pos	Part Number	Description	Remark	Qty	Model		
5	911 551 023 00 80S	Can-can-red	83-	1			
	911 551 023 00 1VD	Champagne	83-				
	911 551 054 03	Carpet					
		Seat well					
		Velour pile	-78				
	911 551 054 03 8AB	Lobster					
	911 551 054 03 5AZ	Cork					
	911 551 054 03 7AZ	Black					
	911 551 054 03 20B	Dark green					
	911 551 054 03 40A	Brown					
	911 551 054 03 8AZ	Light red					
	911 551 054 03 1AY	Yellow					
	911 551 054 03	Carpet					
		Seat well					
		Cut pile	79-				
5	911 551 054 03 5AF	Cork		1			
	911 551 054 03 70E	Black					
	911 551 054 03 2AF	Dark green					
	911 551 054 03 40E	Brown					
	911 551 054 03 8AF	Light red					
	911 551 054 03 1AF	Yellow					
	911 551 054 03 30B	Dark blue	80-				
	911 551 054 03 50B	Beige	80-				
	911 551 054 03 20S	Mint green	81-				
	911 551 054 03 8AY	Russet	80-				
	911 551 054 03 80E	Burgundy					
	911 551 054 03 60A	Grey	83-				
	911 551 054 03 2FL	Grey-beige	83-				
	911 551 054 03 6JD	Dark green	83-				
	911 551 054 03 80S	Can-can-red	83-				
6	911 551 054 03 1VD	Champagne	83-	1			
	911 522 062 02	Carpet	/R				
		Velour pile	78				
	911 522 062 02 8AB	Lobster					
	911 522 062 02 5AZ	Cork					
	911 522 062 02 7AZ	Black					
	911 522 062 02 20B	Dark green					
	911 522 062 02 40A	Brown					
	911 522 062 02 8AZ	Light red					
	911 522 062 02 1AY	Yellow					
	(6) 911 522 061 02	Carpet	/L			1	SC
		Velour pile	78				
	911 522 061 02 8AB	Lobster					
	911 522 061 02 5AZ	Cork					
	911 522 061 02 7AZ	Black					
911 522 061 02 20B	Dark green						
911 522 061 02 40A	Brown						
911 522 061 02 8AZ	Light red						
911 522 061 02 1AY	Yellow						
(6) 930 522 061 00	Carpet	/L	1	TURBO			
	Velour pile	78					
930 522 061 00 8AB	Lobster						
930 522 061 00 5AZ	Cork						
930 522 061 00 7AZ	Black						
930 522 061 00 20B	Dark green						
930 522 061 00 40A	Brown						
930 522 061 00 8AZ	Light red						
930 522 061 00 1AY	Yellow						
6 911 522 062 03	Carpet	/R			1		
	Cut pile	79-					
911 522 062 03 5AF	Cork						
911 522 062 03 70E	Black						
911 522 062 03 2AF	Dark green						

Model: 911 78 Model life 1978>>1983

Pos	Part Number	Description	Remark	Qty	Model
	911 522 062 03 40E	Brown			
	911 522 062 03 8AF	Light red			
	911 522 062 03 1AF	Yellow			
	911 522 062 03 30B	Blue	80-		
	911 522 062 03 50B	Beige	80-		
	911 522 062 03 20S	Mint green	81-		
	911 522 062 03 8AY	Russet	80		
	911 522 062 03 80E	Burgundy			
	911 522 062 03 60A	Grey	83-		
	911 522 062 03 2FL	Grey-beige	83-		
	911 522 062 03 6JD	Dark green	83-		
	911 522 062 03 80S	Can-can-red	83-		
(6)	911 522 061 03	Carpet	/L	1	SC
		Cut pile	79-		
	911 522 061 03 5AF	Cork			
	911 522 061 03 70E	Black			
	911 522 061 03 2AF	Dark green			
	911 522 061 03 40E	Brown			
	911 522 061 03 8AF	Light red			
	911 522 061 03 1AF	Yellow			
	911 522 061 03 30B	Blue	80-		
	911 522 061 03 50B	Beige	80-		
	911 522 061 03 20S	Mint green	81-		
	911 522 061 03 8AY	Russet	80		
	911 522 061 03 80E	Burgundy			
	911 522 061 03 60A	Grey	83-		
	911 522 061 03 2FL	Grey-beige	83-		
	911 522 061 03 6JD	Dark green	83-		
	911 522 061 03 80S	Can-can-red	83-		
(6)	930 522 061 01	Carpet	/L	1	TURBO
		Cut pile	79-		
	930 522 061 01 5AF	Cork			
	930 522 061 01 70E	Black			
	930 522 061 01 2AF	Dark green			
	930 522 061 01 40E	Brown			
	930 522 061 01 8AF	Light red			
	930 522 061 01 1AF	Yellow			
	930 522 061 01 30B	Blue	80-		
	930 522 061 01 50B	Beige	80-		
	930 522 061 01 20S	Mint green	81-		
	930 522 061 01 8AY	Russet	80		
	930 522 061 01 80E	Burgundy			
	930 522 061 01 60A	Grey	83-		
	930 522 061 01 2FL	Grey-beige	83-		
	930 522 061 01 6JD	Dark green	83-		
	930 522 061 01 80S	Can-can-red	83-		
7	911 555 075 03	Back wall lining	-78	1	COUPE
		Leatherette/ Pin stripe velour			
	911 555 075 03 8AK	Lobster/lobster			
	911 555 075 03 5AK	Cork/cork			
	911 555 075 03 7AK	Black/black			
	911 555 075 03 8ZT	Black/lobster			
	911 555 075 03 5ZT	Black/cork			
(7)	911 555 075 12	Back wall lining	(AUS) -78	1	COUPE
		Leatherette/ Pin stripe velour			
	911 555 075 12 8AK	Lobster/lobster			
	911 555 075 12 5AK	Cork/cork			
	911 555 075 12 7AK	Black/black			
	911 555 075 12 8ZT	Black/lobster			
	911 555 075 12 5ZT	Black/cork			
(7)	911 555 075 43	Back wall lining	-78	1	TARGA

Model: 911 78 Model life 1978>>1983

Pos	Part Number	Description	Remark	Qty	Model
		Leatherette/ Pin stripe velour			
	911 555 075 43 8AK	Lobster/lobster			
	911 555 075 43 5AK	Cork/cork			
	911 555 075 43 7AK	Black/black			
	911 555 075 43 8ZT	Black/lobster			
	911 555 075 43 5ZT	Black/cork			
(7)	911 555 075 52	Back wall lining Leatherette/ Pin stripe velour	(AUS) -78	1	TARGA
	911 555 075 52 8AK	Lobster/lobster			
	911 555 075 52 5AK	Cork/cork			
	911 555 075 52 7AK	Black/black			
	911 555 075 52 8ZT	Black/lobster			
	911 555 075 52 5ZT	Black/cork			
7	911 555 075 03	Back wall lining Leatherette/ Tartan cloth	-78	1	COUPE
	911 555 075 03 8ZU	Lobster/ Brown-beige			
	911 555 075 03 5ZU	Cork/ Brown-beige			
	911 555 075 03 8ZZ	Black/ Red-blue			
(7)	911 555 075 12	Back wall lining Leatherette/ Tartan cloth	(AUS) -78	1	COUPE
	911 555 075 12 8ZU	Lobster/ Brown-beige			
	911 555 075 12 5ZU	Cork/ Brown-beige			
	911 555 075 12 8ZZ	Black/ Red-blue			
(7)	911 555 075 43	Back wall lining Leatherette/ Tartan cloth	-78	1	TARGA
	911 555 075 43 8ZU	Lobster/ Brown-beige			
	911 555 075 43 5ZU	Cork/ Brown-beige			
	911 555 075 43 8ZZ	Black/ Red-blue			
(7)	911 555 075 52	Back wall lining Leatherette/ Tartan cloth	(AUS) -78	1	TARGA
	911 555 075 52 8ZU	Lobster/ Brown-beige			
	911 555 075 52 5ZU	Cork/ Brown-beige			
	911 555 075 52 8ZZ	Black/ Red-blue			
(7)	911 555 075 06	Back wall lining Leatherette		1	COUPE
	911 555 075 06 8AU	Lobster	-78		
	911 555 075 06 5AU	Cork			
	911 555 075 06 7AU	Black	-82		
	911 555 075 06 4AU	Brown	79-82		
	911 555 075 06 3AU	Dark blue	80-82		
	911 555 075 06 5BC	Beige	80-		
	911 555 075 06 3MK	Burgundy/burgundy	83-		
	911 555 075 06 05T	Black/black	83-		
	911 555 075 06 1HH	Blue/blue	83-		
	911 555 075 06 4RB	Brown/brown	83-		

Model: 911 78 Model life 1978>>1983

Pos	Part Number	Description	Remark	Qty	Model
(7)	911 555 075 46	Back wall lining Leatherette		1	TARGA
	911 555 075 46 8AU	Lobster	-78		
	911 555 075 46 5AU	Cork			
	911 555 075 46 7AU	Black	-82		
	911 555 075 46 4AU	Brown	79-82		
	911 555 075 46 3AU	Dark blue	80-82		
	911 555 075 46 5BC	Beige	80-		
	911 555 075 46 3MK	Burgundy	83-		
	911 555 075 46 05T	Black	83-		
	911 555 075 46 1HH	Blue	83-		
	911 555 075 46 4RB	Brown	83-		
(7)	911 555 075 80	Back wall lining Leather		1	COUPE
	911 555 075 80 8AH	Lobster	-78		
	911 555 075 80 5AH	Cork	-79		
	911 555 075 80 7AG	Black	-79		
	911 555 075 80 20B	Dark green			
	911 555 075 80 2AP	Light green	-78		
	911 555 075 80 3NG	Brown	-82		
	911 555 075 80 3AG	Blue	-79		
	911 555 075 80 8AT	Light red	-79		
	911 555 075 80 1AG	Yellow	-79		
	911 555 075 80 9AG	White	-79		
	911 555 075 80 1AJ	Black	80-82		
	911 555 075 80 30B	Dark blue	80-82		
	911 555 075 80 50B	Beige	80-		
	911 555 075 80 30A	Blue	80		
	911 555 075 80 80B	Light red	80		
	911 555 075 80 10A	Yellow	80		
	911 555 075 80 99A	White	80		
	911 555 075 80 40D	Cork	80		
	911 555 075 80 80S	Can-can-red	81-		
	911 555 075 80 95S	Papyrus	81-		
	911 555 075 80 60S	Hannibal grey	81-		
	911 555 075 80 20S	Mint green	81-		
	911 555 075 80 6AD	Doric grey	80		
	911 555 075 80 KZ2	Black/black	83-		
	911 555 075 80 KZ3	Blue	83-		
	911 555 075 80 KZ5	Brown	83-		
	911 555 075 80 LG7	Burgundy	83-		
	911 555 075 80 LG6	Dark green	83-		
(7)	911 555 075 81	Back wall lining Leather		1	TARGA
	911 555 075 81 8AH	Lobster	-78		
	911 555 075 81 5AH	Cork	-79		
	911 555 075 81 7AG	Black	-79		
	911 555 075 81 20B	Dark green			
	911 555 075 81 2AP	Dark green	-78		
	911 555 075 81 3NG	Brown	-82		
	911 555 075 81 3AG	Blue	-79		
	911 555 075 81 8AT	Light red	-79		
	911 555 075 81 1AG	Yellow	-79		
	911 555 075 81 9AG	White	-79		
	911 555 075 81 1AJ	Black	80-82		
	911 555 075 81 30B	Dark blue	80-82		
	911 555 075 81 50B	Beige	80-		
	911 555 075 81 30A	Blue	80		
	911 555 075 81 80B	Light red	80		
	911 555 075 81 10A	Yellow	80		
	911 555 075 81 99A	White	80		
	911 555 075 81 40D	Cork	80		
	911 555 075 81 80S	Can-can-red	81-		

Model: 911 78 Model life 1978>>1983

Pos	Part Number	Description	Remark	Qty	Model
	911 555 075 81 95S	Papyrus	81-		
	911 555 075 81 60S	Hannibal grey	81-		
	911 555 075 81 20S	Mint green	81-		
	911 555 075 81 6AD	Doric grey	80		
	911 555 075 81 KZ2	Black	83-		
	911 555 075 81 KZ3	Blue	83-		
	911 555 075 81 KZ5	Brown	83-		
	911 555 075 81 LG7	Burgundy	83-		
	911 555 075 81 LG6	Dark green	83-		
(7)	911 555 075 09	Back wall lining Leather/ Pin stripe velour	-78	1	COUPE
	911 555 075 09 8AK	Lobster/lobster			
	911 555 075 09 5AK	Cork/cork			
	911 555 075 09 7AK	Black/black			
	911 555 075 09 8ZT	Black/lobster			
	911 555 075 09 5ZT	Black/cork			
(7)	911 555 075 87	Back wall lining Leather/ Pin stripe velour	(AUS) -78	1	COUPE
	911 555 075 87 8AK	Lobster/lobster			
	911 555 075 87 5AK	Cork/cork			
	911 555 075 87 7AK	Black/black			
	911 555 075 87 8ZT	Black/lobster			
	911 555 075 87 5ZT	Black/cork			
(7)	911 555 075 49	Back wall lining Leather/ Pin stripe velour	-78	1	TARGA
	911 555 075 49 8AK	Lobster/lobster			
	911 555 075 49 5AK	Cork/cork			
	911 555 075 49 7AK	Black/black			
	911 555 075 49 8ZT	Black/lobster			
	911 555 075 49 5ZT	Black/cork			
(7)	911 555 075 85	Back wall lining Leather/ Pin stripe velour	(AUS) -78	1	TARGA
	911 555 075 85 8AK	Lobster/lobster			
	911 555 075 85 5AK	Cork/cork			
	911 555 075 85 7AK	Black/black			
	911 555 075 85 8ZT	Black/lobster			
	911 555 075 85 5ZT	Black/cork			
(7)	911 555 075 09	Back wall lining Leather/ Tartan cloth	-78	1	COUPE
	911 555 075 09 8ZU	Brown/white/beige Brown-beige			
	911 555 075 09 5ZU	Brown/white/beige Brown-beige			
	911 555 075 09 8ZZ	Red/blue/black Red-blue			
	911 555 075 09 2ZZ	Green/blue/black Green-blue			
	911 555 075 09 4ZZ	Brown/white/beige Brown-beige			
(7)	911 555 075 87	Back wall lining Leather/ Tartan cloth	(AUS) -78	1	COUPE
	911 555 075 87 8ZU	Brown/white/beige Brown-beige			
	911 555 075 87 5ZU	Brown/white/beige Brown-beige			
	911 555 075 87 8ZZ	Red/blue/black Red-blue			

Model: 911 78 Model life 1978>>1983

Pos	Part Number	Description	Remark	Qty	Model
	911 555 075 87 2ZZ	Green/blue/black Green-blue			
	911 555 075 87 4ZZ	Brown/white/beige Brown-beige			
(7)	911 555 075 49	Back wall lining Leather/ Tartan cloth	-78	1	TARGA
	911 555 075 49 8ZU	Brown/white/beige Brown-beige			
	911 555 075 49 5ZU	Brown/white/beige Brown-beige			
	911 555 075 49 8ZZ	Red/blue/black Red-blue			
	911 555 075 49 2ZZ	Green/blue/black Green-blue			
	911 555 075 49 4ZZ	Brown/white/beige Brown-beige			
(7)	911 555 075 85	Back wall lining Leather/ Tartan cloth	(AUS) -78	1	TARGA
	911 555 075 85 8ZU	Brown/white/beige Brown-beige			
	911 555 075 85 5ZU	Brown/white/beige Brown-beige			
	911 555 075 85 8ZZ	Red/blue/black Red-blue			
	911 555 075 85 2ZZ	Green/blue/black Green-blue			
	911 555 075 85 4ZZ	Brown/white/beige Brown-beige			
8	911 645 007 13	Back wall lining Leatherette/ Pin stripe velour	-78	1	COUPE
	911 645 007 13 8AK	Lobster/lobster			
	911 645 007 13 5AK	Cork/cork			
	911 645 007 13 7AK	Black/lobster			
	911 645 007 13 8ZT	Black/lobster			
	911 645 007 13 5ZT	Black/cork			
8	911 645 007 18	Back wall lining Leatherette/ Pin stripe velour	(AUS) -78	1	COUPE
	911 645 007 18 8AK	Lobster/lobster			
	911 645 007 18 5AK	Cork/cork			
	911 645 007 18 7AK	Black/black			
	911 645 007 18 8ZT	Black/lobster			
	911 645 007 18 5ZT	Black/cork			
8	911 645 007 43	Back wall lining Leatherette/ Pin stripe velour	-78	1	TARGA
	911 645 007 43 8AK	Lobster/lobster			
	911 645 007 43 5AK	Cork/cork			
	911 645 007 43 7AK	Black/black			
	911 645 007 43 8ZT	Black/lobster			
	911 645 007 43 5ZT	Black/cork			
8	911 645 007 54	Back wall lining Leatherette/ Pin stripe velour	(AUS) -78	1	TARGA
	911 645 007 54 8AK	Lobster/lobster			
	911 645 007 54 5AK	Cork/cork			
	911 645 007 54 7AK	Black/black			
	911 645 007 54 8ZT	Black/lobster			
	911 645 007 54 5ZT	Black/cork			
8	911 645 007 13	Back wall lining	-78	1	COUPE

Model: 911 78 Model life 1978>>1983

Pos	Part Number	Description	Remark	Qty	Model
	911 645 007 13 8ZU	Leatherette/ Tartan cloth Brown/white/beige			
	911 645 007 13 5ZU	Brown-beige Brown/white/beige			
	911 645 007 13 8ZZ	Brown-beige Red/blue/black			
8	911 645 007 18	Red-blue Back wall lining Leatherette/ Tartan cloth	(AUS) -78	1	COUPE
	911 645 007 18 8ZU	Lobster/ Brown-beige			
	911 645 007 18 5ZU	Cork/ Brown-beige			
	911 645 007 18 8ZZ	Black/ Red-blue			
8	911 645 007 43	Back wall lining Leatherette/ Tartan cloth	-78	1	TARGA
	911 645 007 43 8ZU	Brown/white/beige Brown-beige			
	911 645 007 43 5ZU	Brown/white/beige Brown-beige			
	911 645 007 43 8ZZ	Red/blue/black Red-blue			
8	911 645 007 54	Back wall lining Leatherette/ Tartan cloth	(AUS) -78	1	TARGA
	911 645 007 54 8ZU	Lobster/ Brown-beige			
	911 645 007 54 5ZU	Cork/ Brown-beige			
	911 645 007 54 8ZZ	Black/ Red-blue			
8	911 555 111 00	Back wall lining Leatherette		1	COUPE
	911 555 111 00 8AU	Lobster	-78		
	911 555 111 00 5AU	Cork			
	911 555 111 00 7AU	Black	-82		
	911 555 111 00 4AU	Brown	79-82		
	911 555 111 00 3AU	Dark blue	80-82		
	911 555 111 00 5BC	Beige	80-		
	911 555 111 00 05T	Black/black	83-		
	911 555 111 00 1HH	Blue/blue	83-		
	911 555 111 00 4RB	Brown/brown	83-		
	911 555 111 00 3MK	Burgundy/burgundy	83-		
8	911 555 111 02	Back wall lining Leatherette	(AUS)	1	COUPE
	911 555 111 02 8AU	Lobster	-78		
	911 555 111 02 5AU	Cork			
	911 555 111 02 7AU	Black	-82		
	911 555 111 02 4AU	Brown	79-82		
	911 555 111 02 3AU	Dark blue	80-82		
	911 555 111 02 5BC	Beige	80-		
	911 555 111 02 05T	Black	83-		
	911 555 111 02 1HH	Blue/blue	83-		
	911 555 111 02 4RB	Brown/brown	83-		
	911 555 111 02 3MK	Burgundy	83-		
8	911 555 111 10	Back wall lining Leatherette		1	COUPE
	911 555 111 10 8AU	Lobster	-78		
	911 555 111 10 5AU	Cork			

Model: 911 78 Model life 1978>>1983

Pos	Part Number	Description	Remark	Qty	Model
8	911 555 111 10 7AU	Black	-82	1	COUPE
	911 555 111 10 4AU	Brown	79-82		
	911 555 111 10 3AU	Dark blue	80-82		
	911 555 111 10 5BC	Beige	80-		
	911 555 111 10 05T	Black/black	83-		
	911 555 111 10 1HH	Blue/blue	83-		
	911 555 111 10 4RB	Brown/brown	83-		
	911 555 111 10 3MK	Burgundy/burgundy	83-		
	911 555 111 12	Back wall lining Leatherette	(AUS)		
	911 555 111 12 8AU	Lobster	-78		
	911 555 111 12 5AU	Cork			
	911 555 111 12 7AU	Black	-82		
	911 555 111 12 4AU	Brown	79-82		
	911 555 111 12 3AU	Dark blue	80-82		
8	911 555 111 12 5BC	Beige	80-	1	TARGA
	911 555 111 12 05T	Black/black	83-		
	911 555 111 12 1HH	Blue/blue	83-		
	911 555 111 12 4RB	Brown/brown	83-		
	911 555 111 12 3MK	Burgundy/burgundy	83-		
	911 555 111 40	Back wall lining Leatherette			
	911 555 111 40 8AU	Lobster	-78		
	911 555 111 40 5AU	Cork			
	911 555 111 40 7AU	Black	-82		
	911 555 111 40 4AU	Brown	79-82		
	911 555 111 40 3AU	Brown	80-82		
	911 555 111 40 5BC	Beige	80-		
	911 555 111 40 05T	Black	83-		
	911 555 111 40 1HH	Blue	83-		
8	911 555 111 40 4RB	Brown	83-	1	TARGA
	911 555 111 40 3MK	Burgundy	83-		
	911 555 111 41	Back wall lining Leatherette	(AUS)		
	911 555 111 41 8AU	Lobster	-78		
	911 555 111 41 5AU	Cork			
	911 555 111 41 7AU	Black	-82		
	911 555 111 41 4AU	Brown	79-82		
	911 555 111 41 3AU	Dark blue	80-82		
	911 555 111 41 5BC	Beige	80-		
	911 555 111 41 05T	Black	83-		
	911 555 111 41 1HH	Blue	83-		
	911 555 111 41 4RB	Brown	83-		
	911 555 111 41 3MK	Burgundy	83-		
	8	911 555 112 00	Back wall lining Leatherette		
911 555 112 00 8AU		Lobster	-78		
911 555 112 00 5AU		Cork			
911 555 112 00 7AU		Black	-82		
911 555 112 00 4AU		Brown	79-82		
911 555 112 00 3AU		Dark blue	80-82		
911 555 112 00 5BC		Beige	80-		
911 555 112 00 05T		Black/black	83-		
911 555 112 00 1HH		Blue/blue	83-		
911 555 112 00 4RB		Brown/brown	83-		
911 555 112 00 3MK		Burgundy/burgundy	83-		
911 555 112 02		Back wall lining Leatherette	(AUS)		
911 555 112 02 8AU		Lobster	-78		
911 555 112 02 5AU		Cork			
911 555 112 02 7AU	Black	-82			
911 555 112 02 4AU	Brown	79-82			
911 555 112 02 3AU	Dark blue	80-82			

Model: 911 78 Model life 1978>>1983

Pos	Part Number	Description	Remark	Qty	Model
8	911 555 112 02 5BC	Beige	80-	1	COUPE
	911 555 112 02 05T	Black/black	83-		
	911 555 112 02 1HH	Blue/blue	83-		
	911 555 112 02 4RB	Brown/brown	83-		
	911 555 112 02 3MK	Burgundy/burgundy	83-		
	911 555 111 01	Back wall lining			
		Leather			
	911 555 111 01 8AH	Lobster	-78		
	911 555 111 01 5AH	Cork	-79		
	911 555 111 01 7AG	Black	-79		
	911 555 111 01 20B	Dark green			
	911 555 111 01 2AP	Light green	78		
	911 555 111 01 3NG	Brown	-82		
	911 555 111 01 3AG	Blue	-79		
	911 555 111 01 8AT	Light red	-79		
	911 555 111 01 1AG	Yellow	-79		
	911 555 111 01 9AG	White	-79		
	911 555 111 01 1AJ	Black	80-82		
	911 555 111 01 30B	Dark blue	80-82		
	911 555 111 01 50B	Beige	80-		
	911 555 111 01 30A	Blue	80-		
	911 555 111 01 80B	Light red	80-		
	911 555 111 01 10A	Yellow	80-		
	911 555 111 01 99A	White	80-		
	911 555 111 01 40D	Cork	80-		
	911 555 111 01 80S	Can-can-red	81-		
	911 555 111 01 95S	Papyrus	81-		
	911 555 111 01 60S	Hannibal grey	81-		
	911 555 111 01 20S	Mint green	81-		
	911 555 111 01 6AD	Doric grey	80		
	911 555 111 01 KZ2	Black	83-		
	911 555 111 01 KZ3	Blue	83-		
911 555 111 01 KZ5	Brown	83-			
911 555 111 01 LG7	Burgundy	83-			
911 555 111 01 LG6	Dark green	83			
8	911 555 111 03	Back wall lining	(AUS)	1	COUPE
		Leather			
911 555 111 03 8AH	Lobster	-78			
911 555 111 03 5AH	Cork	-79			
911 555 111 03 7AG	Black	-79			
911 555 111 03 20B	Dark green				
911 555 111 03 2AP	Light green	78			
911 555 111 03 3NG	Brown	-82			
911 555 111 03 3AG	Blue	-79			
911 555 111 03 8AT	Light red	-79			
911 555 111 03 1AG	Yellow	-79			
911 555 111 03 9AG	White	-79			
911 555 111 03 1AJ	Black	80-82			
911 555 111 03 30B	Dark blue	80-82			
911 555 111 03 50B	Beige	80-			
911 555 111 03 30A	Blue	80-			
911 555 111 03 80B	Light red	80-			
911 555 111 03 10A	Yellow	80-			
911 555 111 03 99A	White	80-			
911 555 111 03 40D	Cork	80-			
911 555 111 03 80S	Can-can-red	81-			
911 555 111 03 95S	Papyrus	81-			
911 555 111 03 60S	Hannibal grey	81-			
911 555 111 03 20S	Mint green	81-			
911 555 111 03 6AD	Doric grey	80			
911 555 111 03 KZ2	Black	83-			
911 555 111 03 KZ3	Blue	83-			
911 555 111 03 KZ5	Brown	83-			

Model: 911 78 Model life 1978>>1983

Pos	Part Number	Description	Remark	Qty	Model
8	911 555 111 03 LG7	Burgundy	83-	1	COUPE
	911 555 111 03 LG6	Dark green	83		
	911 555 111 11	Back wall lining Leather			
	911 555 111 11 8AH	Lobster	-78		
	911 555 111 11 5AH	Cork	-79		
	911 555 111 11 7AG	Black	-79		
	911 555 111 11 20B	Dark green			
	911 555 111 11 2AP	Light green	78		
	911 555 111 11 3NG	Brown	-82		
	911 555 111 11 3AG	Blue	-79		
	911 555 111 11 8AT	Light red	-79		
	911 555 111 11 1AG	Yellow	-79		
	911 555 111 11 9AG	White	-79		
	911 555 111 11 1AJ	Black	80-82		
	911 555 111 11 30B	Dark blue	80-82		
	911 555 111 11 50B	Beige	80-		
	911 555 111 11 30A	Blue	80-		
	911 555 111 11 80B	Light red	80-		
	911 555 111 11 10A	Yellow	80-		
	911 555 111 11 99A	White	80-		
	911 555 111 11 40D	Cork	80-		
	911 555 111 11 80S	Can-can-red	81-		
	911 555 111 11 95S	Papyrus	81-		
	911 555 111 11 60S	Hannibal grey	81-		
	911 555 111 11 20S	Mint green	81-		
	911 555 111 11 6AD	Doric grey	80		
	911 555 111 11 KZ2	Black/black	83-		
911 555 111 11 KZ3	Blue/blue	83-			
911 555 111 11 KZ5	Brown/brown	83-			
911 555 111 11 LG7	Burgundy/burgundy	83-			
911 555 111 11 LG6	Dark green	83			
8	911 555 111 13	Back wall lining Leather	(AUS)	1	COUPE
	911 555 111 13 8AH	Lobster	-78		
	911 555 111 13 5AH	Cork	-79		
	911 555 111 13 7AG	Black	-79		
	911 555 111 13 20B	Dark green			
	911 555 111 13 2AP	Light green	78		
	911 555 111 13 3NG	Brown	-82		
	911 555 111 13 3AG	Blue	-79		
	911 555 111 13 8AT	Light red	-79		
	911 555 111 13 1AG	Yellow	-79		
	911 555 111 13 9AG	White	-79		
	911 555 111 13 1AJ	Black	80-82		
	911 555 111 13 30B	Dark blue	80-82		
	911 555 111 13 50B	Beige	80-		
	911 555 111 13 30A	Blue	80-		
	911 555 111 13 80B	Light red	80-		
	911 555 111 13 10A	Yellow	80-		
	911 555 111 13 99A	White	80-		
	911 555 111 13 40D	Cork	80-		
	911 555 111 13 80S	Can-can-red	81-		
	911 555 111 13 95S	Papyrus	81-		
	911 555 111 13 60S	Hannibal grey	81-		
	911 555 111 13 20S	Mint green	81-		
	911 555 111 13 6AD	Doric grey	80		
	911 555 111 13 KZ2	Black/black	83-		
	911 555 111 13 KZ3	Blue	83-		
	911 555 111 13 KZ5	Brown	83-		
911 555 111 13 LG7	Burgundy/burgundy	83-			
911 555 111 13 LG6	Dark green	83			
8	911 555 111 42	Back wall lining		1	TARGA

Model: 911 78 Model life 1978>>1983

Pos	Part Number	Description	Remark	Qty	Model
		Leather			
	911 555 111 42 8AH	Lobster	-78		
	911 555 111 42 5AH	Cork	-79		
	911 555 111 42 7AG	Black	-79		
	911 555 111 42 20B	Dark green			
	911 555 111 42 2AP	Light green	78		
	911 555 111 42 3NG	Brown	-82		
	911 555 111 42 3AG	Blue	-79		
	911 555 111 42 8AT	Light red	-79		
	911 555 111 42 1AG	Yellow	-79		
	911 555 111 42 9AG	White	-79		
	911 555 111 42 1AJ	Black	80-82		
	911 555 111 42 30B	Dark blue	80-82		
	911 555 111 42 50B	Beige	80-		
	911 555 111 42 30A	Blue	80-		
	911 555 111 42 80B	Light red	80-		
	911 555 111 42 10A	Yellow	80-		
	911 555 111 42 99A	White	80-		
	911 555 111 42 40D	Cork	80-		
	911 555 111 42 80S	Can-can-red	81-		
	911 555 111 42 95S	Papyrus	81-		
	911 555 111 42 60S	Hannibal grey	81-		
	911 555 111 42 20S	Mint green	81-		
	911 555 111 42 6AD	Doric grey	80		
	911 555 111 42 KZ2	Black	83-		
	911 555 111 42 KZ3	Blue/blue	83-		
	911 555 111 42 KZ5	Brown/brown	83-		
	911 555 111 42 LG7	Burgundy/burgundy	83-		
	911 555 111 42 LG6	Dark green	83		
8	911 555 111 43	Back wall lining	(AUS)	1	TARGA
		Leather			
	911 555 111 43 8AH	Lobster	-78		
	911 555 111 43 5AH	Cork	-79		
	911 555 111 43 7AG	Black	-79		
	911 555 111 43 20B	Dark green			
	911 555 111 43 2AP	Light green	78		
	911 555 111 43 3NG	Brown	-82		
	911 555 111 43 3AG	Blue	-79		
	911 555 111 43 8AT	Light red	-79		
	911 555 111 43 1AG	Yellow	-79		
	911 555 111 43 9AG	White	-79		
	911 555 111 43 1AJ	Black	80-82		
	911 555 111 43 30B	Dark blue	80-82		
	911 555 111 43 50B	Beige	80-		
	911 555 111 43 30A	Blue	80-		
	911 555 111 43 80B	Light red	80-		
	911 555 111 43 10A	Yellow	80-		
	911 555 111 43 99A	White	80-		
	911 555 111 43 40D	Cork	80-		
	911 555 111 43 80S	Can-can-red	81-		
	911 555 111 43 95S	Papyrus	81-		
	911 555 111 43 60S	Hannibal grey	81-		
	911 555 111 43 20S	Mint green	81-		
	911 555 111 43 6AD	Doric grey	80		
	911 555 111 43 KZ2	Black	83-		
	911 555 111 43 KZ3	Blue/blue	83-		
	911 555 111 43 KZ5	Brown/brown	83-		
	911 555 111 43 LG7	Burgundy/burgundy	83-		
	911 555 111 43 LG6	Dark green	83		
8	911 555 112 01	Back wall lining		1	TARGA
		Leather			
	911 555 112 01 8AH	Lobster	-78		
	911 555 112 01 5AH	Cork	-79		

Model: 911 78 Model life 1978>>1983

Pos	Part Number	Description	Remark	Qty	Model
	911 555 112 01 7AG	Black	-79		
	911 555 112 01 20B	Dark green			
	911 555 112 01 2AP	Light green	78		
	911 555 112 01 3NG	Brown	-82		
	911 555 112 01 3AG	Blue	-79		
	911 555 112 01 8AT	Light red	-79		
	911 555 112 01 1AG	Yellow	-79		
	911 555 112 01 9AG	White	-79		
	911 555 112 01 1AJ	Black	80-82		
	911 555 112 01 30B	Dark blue	80-82		
	911 555 112 01 50B	Beige	80-		
	911 555 112 01 30A	Blue	80-		
	911 555 112 01 80B	Light red	80-		
	911 555 112 01 10A	Yellow	80-		
	911 555 112 01 99A	White	80-		
	911 555 112 01 40D	Cork	80-		
	911 555 112 01 80S	Can-can-red	81-		
	911 555 112 01 95S	Papyrus	81-		
	911 555 112 01 60S	Hannibal grey	81-		
	911 555 112 01 20S	Mint green	81-		
	911 555 112 01 6AD	Doric grey	80		
	911 555 112 01 KZ2	Black/black	83-		
	911 555 112 01 KZ3	Blue	83-		
	911 555 112 01 KZ5	Brown	83-		
	911 555 112 01 LG7	Burgundy/burgundy	83-		
	911 555 112 01 LG6	Dark green	83		
8	911 555 112 03	Back wall lining Leather	(AUS)	1	TARGA
	911 555 112 03 8AH	Lobster	-78		
	911 555 112 03 5AH	Cork	-79		
	911 555 112 03 7AG	Black	-79		
	911 555 112 03 20B	Dark green			
	911 555 112 03 2AP	Light green	78		
	911 555 112 03 3NG	Brown	-82		
	911 555 112 03 3AG	Blue	-79		
	911 555 112 03 8AT	Light red	-79		
	911 555 112 03 1AG	Yellow	-79		
	911 555 112 03 9AG	White	-79		
	911 555 112 03 1AJ	Black	80-82		
	911 555 112 03 30B	Dark blue	80-82		
	911 555 112 03 50B	Beige	80-		
	911 555 112 03 30A	Blue	80-		
	911 555 112 03 80B	Light red	80-		
	911 555 112 03 10A	Yellow	80-		
	911 555 112 03 99A	White	80-		
	911 555 112 03 40D	Cork	80-		
	911 555 112 03 80S	Can-can-red	81-		
	911 555 112 03 95S	Papyrus	81-		
	911 555 112 03 60S	Hannibal grey	81-		
	911 555 112 03 20S	Mint green	81-		
	911 555 112 03 6AD	Doric grey	80		
	911 555 112 03 KZ2	Black/black	83-		
	911 555 112 03 KZ3	Blue	83-		
	911 555 112 03 KZ5	Brown	83-		
	911 555 112 03 LG7	Burgundy/burgundy	83-		
	911 555 112 03 LG6	Dark green	83		
8	911 645 007 10	Back wall lining Leather/ Pin stripe velour	-78	1	COUPE
	911 645 007 10 8AK	Lobster/lobster			
	911 645 007 10 5AK	Cork/cork			
	911 645 007 10 7AK	Black/black			
	911 645 007 10 8ZT	Black/lobster			

Model: 911 78 Model life 1978>>1983

Pos	Part Number	Description	Remark	Qty	Model
8	911 645 007 10 5ZT 930 645 007 81	Black/cork Back wall lining Leather/ Pin stripe velour	(AUS) -78	1	COUPE
	930 645 007 81 8AK 930 645 007 81 5AK 930 645 007 81 7AK 930 645 007 81 8ZT 930 645 007 81 5ZT	Lobster/lobster Cork/cork Black/black Black/lobster Black/cork			
8	911 645 007 52	Back wall lining Leather/ Pin stripe velour	-78	1	TARGA
	911 645 007 52 8AK 911 645 007 52 5AK 911 645 007 52 7AK 911 645 007 52 8ZT 911 645 007 52 5ZT	Lobster/lobster Cork/cork Black/black Black/lobster Black/cork			
8	911 645 007 85	Back wall lining Leather/ Pin stripe velour	(AUS) -78	1	TARGA
	911 645 007 85 8AK 911 645 007 85 5AK 911 645 007 85 7AK 911 645 007 85 8ZT 911 645 007 85 5ZT	Lobster/lobster Cork/cork Black/black Black/lobster Black/cork			
8	911 645 007 10	Back wall lining Leather/ Tartan cloth	-78	1	COUPE
	911 645 007 10 8ZU 911 645 007 10 5ZU 911 645 007 10 8ZZ 911 645 007 10 2ZZ 911 645 007 10 4ZZ	Brown/white/beige Brown-beige Brown/white/beige Brown-beige Red/blue/black Red-blue Green/blue/black Green-blue Brown/white/beige Brown-beige			
8	930 645 007 81	Back wall lining Leather/ Tartan cloth	(AUS) -78	1	COUPE
	930 645 007 81 8ZU 930 645 007 81 5ZU 930 645 007 81 8ZZ 930 645 007 81 2ZZ 930 645 007 81 4ZZ	Lobster/ Brown-beige Cork/ Brown-beige Black/ Red-blue Black/ Green-blue Black/ Brown-beige			
8	911 645 007 52	Back wall lining Leather/ Tartan cloth	-78	1	TARGA
	911 645 007 52 8ZU 911 645 007 52 5ZU 911 645 007 52 8ZZ 911 645 007 52 2ZZ 911 645 007 52 4ZZ	Brown/white/beige Brown-beige Brown/white/beige Brown-beige Red/blue/black Red-blue Green/blue/black Green-blue Brown/white/beige			

Model: 911 78 Model life 1978>>1983

Pos	Part Number	Description	Remark	Qty	Model
8	911 645 007 85	Brown-beige Back wall lining	(AUS) -78	1	TARGA
	911 645 007 85 8ZU	Leather/ Tartan cloth Lobster/ Brown-beige			
	911 645 007 85 5ZU	Cork/ Brown-beige			
	911 645 007 85 8ZZ	Black/ Red-blue			
	911 645 007 85 2ZZ	Black/ Green-blue			
	911 645 007 85 4ZZ	Black/ Brown-beige			
8	911 645 007 10	Back wall lining		1	COUPE M403
	911 645 007 10 HS6	Leather/ Stripe design Grey-burgundy Grey-burgundy			
8A	911 555 019 00	Loudspeaker grille		2	
9	900 145 072 07	Tapping screw B 3,5 X 22		2	
(9)	900 145 008 07	Tapping screw B 3,5 X 32	(AUS)	2	
10	999 591 102 17	Washer		2	
10	999 591 102 1H	Washer		2	
(10)	900 151 024 40	Washer A 4,3	(AUS)	4	
11	911 803 521 00	Knurled head	(AUS)	4	
12	911 555 071 05	Side trim panel Leatherette	/L	1	COUPE
	911 555 071 05 8AU	Lobster	-78		
	911 555 071 05 5AU	Cork			
	911 555 071 05 7AU	Black	-82		
	911 555 071 05 4AU	Brown	79-82		
	911 555 071 05 3AU	Dark blue	80-82		
	911 555 071 05 5BC	Beige	80-		
	911 555 071 05 3MK	Burgundy	83-		
	911 555 071 05 4FK	Grey-beige	83-		
	911 555 071 05 05T	Black	83-		
	911 555 071 05 1HH	Blue	83-		
	911 555 071 05 4RB	Brown	83-		
(12)	911 555 072 05	Side trim panel Leatherette	/R	1	COUPE
	911 555 072 05 8AU	Lobster	-78		
	911 555 072 05 5AU	Cork			
	911 555 072 05 7AU	Black	-82		
	911 555 072 05 4AU	Brown	79-82		
	911 555 072 05 3AU	Dark blue	80-82		
	911 555 072 05 5BC	Beige	80-		
	911 555 072 05 3MK	Burgundy	83-		
	911 555 072 05 4FK	Grey-beige	83-		
	911 555 072 05 05T	Black	83-		
	911 555 072 05 1HH	Blue	83-		
	911 555 072 05 4RB	Brown	83-		
(12)	911 555 071 47	Side trim panel Leatherette	/L	1	TARGA
	911 555 071 47 8AU	Lobster	-78		
	911 555 071 47 5AU	Cork			
	911 555 071 47 7AU	Black	-82		
	911 555 071 47 4AU	Brown	79-82		
	911 555 071 47 3AU	Dark blue	80-82		

Model: 911 78 Model life 1978>>1983

Pos	Part Number	Description	Remark	Qty	Model
	911 555 071 47 5BC	Beige	80-		
	911 555 071 47 3MK	Burgundy	83-		
	911 555 071 47 4FK	Grey-beige	83-		
	911 555 071 47 05T	Black	83-		
	911 555 071 47 1HH	Blue	83-		
	911 555 071 47 4RB	Brown	83-		
(12)	911 555 072 47	Side trim panel Leatherette	/R	1	TARGA
	911 555 072 47 8AU	Lobster	-78		
	911 555 072 47 5AU	Cork			
	911 555 072 47 7AU	Black	-82		
	911 555 072 47 4AU	Brown	79-82		
	911 555 072 47 3AU	Dark blue	80-82		
	911 555 072 47 5BC	Beige	80-		
	911 555 072 47 3MK	Burgundy	83-		
	911 555 072 47 4FK	Grey-beige	83-		
	911 555 072 47 05T	Black	83-		
	911 555 072 47 1HH	Blue	83-		
	911 555 072 47 4RB	Brown	83-		
(12)	911 555 071 79	Side trim panel Pin stripe velour	/L (AUS) 78	1	COUPE
	911 555 071 79 8AK	Lobster			
	911 555 071 79 5AK	Cork			
	911 555 071 79 7AK	Black			
(12)	911 555 072 79	Side trim panel Pin stripe velour	/R (AUS) 78	1	COUPE
	911 555 072 79 8AK	Lobster			
	911 555 072 79 5AK	Cork			
	911 555 072 79 7AK	Black			
(12)	911 555 071 76	Side trim panel Pin stripe velour	/L 78	1	TARGA
	911 555 071 76 8AK	Lobster			
	911 555 071 76 5AK	Cork			
	911 555 071 76 7AK	Black			
(12)	911 555 072 76	Side trim panel Pin stripe velour	/R 78	1	TARGA
	911 555 072 76 8AK	Lobster			
	911 555 072 76 5AK	Cork			
	911 555 072 76 7AK	Black			
(12)	911 555 071 81	Side trim panel Pin stripe velour	/L (AUS) 78	1	TARGA
	911 555 071 81 8AK	Lobster			
	911 555 071 81 5AK	Cork			
	911 555 071 81 7AK	Black			
(12)	911 555 072 81	Side trim panel Pin stripe velour	/R (AUS) 78	1	TARGA
	911 555 072 81 8AK	Lobster			
	911 555 072 81 5AK	Cork			
	911 555 072 81 7AK	Black			
(12)	911 555 071 79	Side trim panel Tartan cloth	/L (AUS) 78	1	COUPE
	911 555 071 79 8AB	Red-blue			
	911 555 071 79 2AC	Green-blue			
	911 555 071 79 4AD	Brown-beige			
(12)	911 555 072 79	Side trim panel Tartan cloth	/R (AUS) 78	1	COUPE
	911 555 072 79 8AB	Red-blue			
	911 555 072 79 2AC	Green-blue			
	911 555 072 79 4AD	Brown-beige			
(12)	911 555 071 76	Side trim panel Tartan cloth	/L 78	1	TARGA
	911 555 071 76 8AB	Red-blue			
	911 555 071 76 2AC	Green-blue			

Model: 911 78 Model life 1978>>1983

Pos	Part Number	Description	Remark	Qty	Model
(12)	911 555 071 76 4AD	Brown-beige			
	911 555 072 76	Side trim panel	/R 78	1	TARGA
		Tartan cloth			
	911 555 072 76 8AB	Red-blue			
	911 555 072 76 2AC	Green-blue			
(12)	911 555 072 76 4AD	Brown-beige			
	911 555 071 81	Side trim panel	/L (AUS) 78	1	TARGA
		Tartan cloth			
	911 555 071 81 8AB	Red-blue			
	911 555 071 81 2AC	Green-blue			
(12)	911 555 071 81 4AD	Brown-beige			
	911 555 072 81	Side trim panel	/R (AUS) 78	1	TARGA
		Tartan cloth			
	911 555 072 81 8AB	Red-blue			
	911 555 072 81 2AC	Green-blue			
(12)	911 555 072 81 4AD	Brown-beige			
	911 555 071 07	Side trim panel	/L	1	COUPE M403
		Leather/ Stripe design			
	911 555 071 07 HS6	Burgundy/ Grey-burgundy			
(12)	911 555 072 07	Side trim panel	/R	1	COUPE M403
		Leather/ Stripe design			
	911 555 072 07 HS6	Burgundy/ Grey-burgundy			
(12)	911 555 071 76	Side trim panel	/L	1	TARGA M403
		Stripe design			
	911 555 071 76 9LA	Burgundy			
(12)	911 555 072 76	Side trim panel	/R	1	TARGA M403
		Stripe design			
	911 555 072 76 9LA	Burgundy			
(12)	911 555 071 74	Side trim panel	/L	1	COUPE
		Leather			
	911 555 071 74 8AH	Lobster	-78		
	911 555 071 74 5AH	Cork	-79		
	911 555 071 74 7AG	Black	-79		
	911 555 071 74 20B	Dark green	-80		
	911 555 071 74 2AP	Light green	-78		
	911 555 071 74 3NG	Brown	-82		
	911 555 071 74 3AG	Blue	-79		
	911 555 071 74 8AT	Light red	-79		
	911 555 071 74 1AG	Yellow	-79		
	911 555 071 74 9AG	White	-79		
	911 555 071 74 1AJ	Black	80-82		
	911 555 071 74 30B	Dark blue	80-82		
	911 555 071 74 50B	Beige	80-		
	911 555 071 74 30A	Blue	80		
	911 555 071 74 80B	Light red	80		
	911 555 071 74 10A	Yellow	80		
	911 555 071 74 99A	White	80		
	911 555 071 74 40D	Cork	80		
	911 555 071 74 80S	Can-can-red	81-		
	911 555 071 74 95S	Papyrus	81-		
	911 555 071 74 60S	Hannibal grey	81-		
	911 555 071 74 20S	Mint green	81-		
	911 555 071 74 6AD	Doric grey	80		
	911 555 071 74 LG7	Burgundy	83-		
	911 555 071 74 KZ4	Grey-beige	83-		

Model: 911 78 Model life 1978>>1983

Pos	Part Number	Description	Remark	Qty	Model
	911 555 071 74 LG4	Pearl white	83-		
	911 555 071 74 LG5	Champagne	83-		
	911 555 071 74 LG6	Dark green	83-		
	911 555 071 74 KZ2	Black	83-		
	911 555 071 74 KZ3	Blue	83-		
	911 555 071 74 KZ5	Brown	83-		
	911 555 071 74 KZ4	Grey-beige	83-		
	911 555 071 74 KZ6	Can-can-red	83-		
(12)	911 555 072 74	Side trim panel Leather	/R	1	COUPE
	911 555 072 74 8AH	Lobster	-78		
	911 555 072 74 5AH	Cork	-79		
	911 555 072 74 7AG	Black	-79		
	911 555 072 74 20B	Dark green	-80		
	911 555 072 74 2AP	Light green	-78		
	911 555 072 74 3NG	Brown	-82		
	911 555 072 74 3AG	Blue	-79		
	911 555 072 74 8AT	Light red	-79		
	911 555 072 74 1AG	Yellow	-79		
	911 555 072 74 9AG	White	-79		
	911 555 072 74 1AJ	Black	80-82		
	911 555 072 74 30B	Dark blue	80-82		
	911 555 072 74 50B	Beige	80-		
	911 555 072 74 30A	Blue	80		
	911 555 072 74 80B	Light red	80		
	911 555 072 74 10A	Yellow	80		
	911 555 072 74 99A	White	80		
	911 555 072 74 40D	Cork	80		
	911 555 072 74 80S	Can-can-red	81-		
	911 555 072 74 95S	Papyrus	81-		
	911 555 072 74 60S	Hannibal grey	81-		
	911 555 072 74 20S	Mint green	81-		
	911 555 072 74 6AD	Doric grey	80		
	911 555 072 74 LG7	Burgundy	83-		
	911 555 072 74 KZ4	Grey-beige	83-		
	911 555 072 74 LG4	Pearl white	83-		
	911 555 072 74 LG5	Champagne	83-		
	911 555 072 74 LG6	Dark green	83-		
	911 555 072 74 KZ2	Black	83-		
	911 555 072 74 KZ3	Blue	83-		
	911 555 072 74 KZ5	Brown	83-		
	911 555 072 74 KZ4	Grey-beige	83-		
	911 555 072 74 KZ6	Can-can-red	83-		
(12)	911 555 071 78	Side trim panel Leather	/L	1	TARGA
	911 555 071 78 8AH	Lobster	-78		
	911 555 071 78 5AH	Cork	-79		
	911 555 071 78 7AG	Black	-79		
	911 555 071 78 20B	Dark green	-80		
	911 555 071 78 2AP	Light green	-78		
	911 555 071 78 3NG	Brown	-82		
	911 555 071 78 3AG	Blue	-79		
	911 555 071 78 8AT	Light red	-79		
	911 555 071 78 1AG	Yellow	-79		
	911 555 071 78 9AG	White	-79		
	911 555 071 78 1AJ	Black	80-82		
	911 555 071 78 30B	Dark blue	80-82		
	911 555 071 78 50B	Beige	80-		
	911 555 071 78 30A	Blue	80		
	911 555 071 78 80B	Light red	80		
	911 555 071 78 10A	Yellow	80		
	911 555 071 78 99A	White	80		
	911 555 071 78 40D	Cork	80		

Model: 911 78 Model life 1978>>1983

Pos	Part Number	Description	Remark	Qty	Model
	911 555 071 78 80S	Can-can-red	81-		
	911 555 071 78 95S	Papyrus	81-		
	911 555 071 78 60S	Hannibal grey	81-		
	911 555 071 78 20S	Mint green	81-		
	911 555 071 78 6AD	Doric grey	80		
	911 555 071 78 LG7	Burgundy	83-		
	911 555 071 78 KZ4	Grey-beige	83-		
	911 555 071 78 LG4	Pearl white	83-		
	911 555 071 78 LG5	Champagne	83-		
	911 555 071 78 LG6	Dark green	83-		
	911 555 071 78 KZ2	Black	83-		
	911 555 071 78 KZ3	Blue	83-		
	911 555 071 78 KZ5	Brown	83-		
	911 555 071 78 KZ4	Grey-beige	83-		
	911 555 071 78 KZ6	Can-can-red	83-		
(12)	911 555 072 78	Side trim panel Leather	/R	1	TARGA
	911 555 072 78 8AH	Lobster	-78		
	911 555 072 78 5AH	Cork	-79		
	911 555 072 78 7AG	Black	-79		
	911 555 072 78 20B	Dark green	-80		
	911 555 072 78 2AP	Light green	-78		
	911 555 072 78 3NG	Brown	-82		
	911 555 072 78 3AG	Blue	-79		
	911 555 072 78 8AT	Light red	-79		
	911 555 072 78 1AG	Yellow	-79		
	911 555 072 78 9AG	White	-79		
	911 555 072 78 1AJ	Black	80-82		
	911 555 072 78 30B	Dark blue	80-82		
	911 555 072 78 50B	Beige	80-		
	911 555 072 78 30A	Blue	80		
	911 555 072 78 80B	Light red	80		
	911 555 072 78 10A	Yellow	80		
	911 555 072 78 99A	White	80		
	911 555 072 78 40D	Cork	80		
	911 555 072 78 80S	Can-can-red	81-		
	911 555 072 78 95S	Papyrus	81-		
	911 555 072 78 60S	Hannibal grey	81-		
	911 555 072 78 20S	Mint green	81-		
	911 555 072 78 6AD	Doric grey	80		
	911 555 072 78 LG7	Burgundy	83-		
	911 555 072 78 KZ4	Grey-beige	83-		
	911 555 072 78 LG4	Pearl white	83-		
	911 555 072 78 LG5	Champagne	83-		
	911 555 072 78 LG6	Dark green	83-		
	911 555 072 78 KZ2	Black	83-		
	911 555 072 78 KZ3	Blue	83-		
	911 555 072 78 KZ5	Brown	83-		
	911 555 072 78 KZ4	Grey-beige	83-		
	911 555 072 78 KZ6	Can-can-red	83-		
13	911 555 757 00	Cover Lock pillar Leatherette	/L	1	COUPE
	911 555 757 00 8AU	Lobster	-78		
	911 555 757 00 5AU	Cork	-78		
	911 555 757 00 7AU	Black	-82		
	911 555 757 00 4AU	Brown	79-82		
	911 555 757 00 3AU	Dark blue	80-82		
	911 555 757 00 5BC	Beige	80-		
	911 555 757 00 3MK	Burgundy	83-		
	911 555 757 00 4FK	Grey-beige	83-		
	911 555 757 00 05T	Black	83-		
	911 555 757 00 1HH	Blue	83-		

Model: 911 78 Model life 1978>>1983

Pos	Part Number	Description	Remark	Qty	Model
13	911 555 757 00 4RB	Brown	83-	1	COUPE
	911 555 758 00	Cover	/R		
		Lock pillar			
		Leatherette			
	911 555 758 00 8AU	Lobster	-78		
	911 555 758 00 5AU	Cork	-78		
	911 555 758 00 7AU	Black	-82		
	911 555 758 00 4AU	Brown	79-82		
	911 555 758 00 3AU	Dark blue	80-82		
	911 555 758 00 5BC	Beige	80-		
	911 555 758 00 3MK	Burgundy	83-		
	911 555 758 00 4FK	Grey-beige	83-		
	(13)	911 555 758 00 05T	Black		
911 555 758 00 1HH		Blue	83-		
911 555 758 00 4RB		Brown	83-		
911 555 757 40		Cover	/L	1	TARGA/CABRIO
		Lock pillar			
		Leatherette			
911 555 757 40 8AU		Lobster	-78		
911 555 757 40 5AU		Cork	-78		
911 555 757 40 7AU		Black	-82		
911 555 757 40 4AU		Brown	79-82		
911 555 757 40 3AU		Dark blue	80-82		
911 555 757 40 5BC		Beige	80-		
911 555 757 40 3MK		Burgundy	83-		
911 555 757 40 4FK	Grey-beige	83-			
911 555 757 40 05T	Black	83-			
(13)	911 555 757 40 1HH	Blue	83-		
	911 555 757 40 4RB	Brown	83-		
	911 555 758 40	Cover	/R	1	TARGA/CABRIO
		Lock pillar			
		Leatherette			
	911 555 758 40 8AU	Lobster	-78		
	911 555 758 40 5AU	Cork	-78		
	911 555 758 40 7AU	Black	-82		
	911 555 758 40 4AU	Brown	79-82		
	911 555 758 40 3AU	Dark blue	80-82		
	911 555 758 40 5BC	Beige	80-		
	911 555 758 40 3MK	Burgundy	83-		
	911 555 758 40 4FK	Grey-beige	83-		
911 555 758 40 05T	Black	83-			
13	911 555 758 40 1HH	Blue	83-		
	911 555 758 40 4RB	Brown	83-		
	911 555 757 70	Cover	/L	1	COUPE
		Lock pillar			
		Leather			
	911 555 757 70 8AH	Lobster	-78		
	911 555 757 70 5AH	Cork	-79		
	911 555 757 70 7AG	Black	-79		
	911 555 757 70 20B	Dark green	-80		
	911 555 757 70 2AP	Light green	-78		
	911 555 757 70 3NG	Brown	-82		
	911 555 757 70 3AG	Blue	-79		
	911 555 757 70 8AT	Light red	-79		
911 555 757 70 1AG	Yellow	-79			
911 555 757 70 9AG	White	-79			
911 555 757 70 1AJ	Black	80-82			
911 555 757 70 30B	Dark blue	80-82			
911 555 757 70 50B	Beige	80-			
911 555 757 70 30A	Blue	80			
911 555 757 70 80B	Light red	80			
911 555 757 70 10A	Yellow	80			
911 555 757 70 99A	White	80			

Model: 911 78 Model life 1978>>1983

Pos	Part Number	Description	Remark	Qty	Model
	911 555 757 70 40D	Cork	80		
	911 555 757 70 80S	Can-can-red	81-		
	911 555 757 70 95S	Papyrus	81-		
	911 555 757 70 60S	Hannibal grey	81-		
	911 555 757 70 20S	Mint green	81-		
	911 555 757 70 6AD	Doric grey	80		
	911 555 757 70 2LB	Burgundy			
	911 555 757 70 LG7	Burgundy	83-		
	911 555 757 70 KZ4	Grey-beige	83-		
	911 555 757 70 8YD	Pearl white	83-		
	911 555 757 70 1VD	Champagne	83-		
	911 555 757 70 LG6	Dark green	83-		
	911 555 757 70 KZ2	Black	83-		
	911 555 757 70 KZ3	Blue	83-		
	911 555 757 70 KZ5	Brown	83-		
13	911 555 758 70	Cover	/R	1	COUPE
		Lock pillar			
		Leather			
	911 555 758 70 8AH	Lobster	-78		
	911 555 758 70 5AH	Cork	-79		
	911 555 758 70 7AG	Black	-79		
	911 555 758 70 20B	Dark green	-80		
	911 555 758 70 2AP	Light green	-78		
	911 555 758 70 3NG	Brown	-82		
	911 555 758 70 3AG	Blue	-79		
	911 555 758 70 8AT	Light red	-79		
	911 555 758 70 1AG	Yellow	-79		
	911 555 758 70 9AG	White	-79		
	911 555 758 70 1AJ	Black	80-82		
	911 555 758 70 30B	Dark blue	80-82		
	911 555 758 70 50B	Beige	80-		
	911 555 758 70 30A	Blue	80		
	911 555 758 70 80B	Light red	80		
	911 555 758 70 10A	Yellow	80		
	911 555 758 70 99A	White	80		
	911 555 758 70 40D	Cork	80		
	911 555 758 70 80S	Can-can-red	81-		
	911 555 758 70 95S	Papyrus	81-		
	911 555 758 70 60S	Hannibal grey	81-		
	911 555 758 70 20S	Mint green	81-		
	911 555 758 70 6AD	Doric grey	80		
	911 555 758 70 2LB	Burgundy			
	911 555 758 70 LG7	Burgundy	83-		
	911 555 758 70 KZ4	Grey-beige	83-		
	911 555 758 70 8YD	Pearl white	83-		
	911 555 758 70 1VD	Champagne	83-		
	911 555 758 70 LG6	Dark green	83-		
	911 555 758 70 KZ2	Black	83-		
	911 555 758 70 KZ3	Blue	83-		
	911 555 758 70 KZ5	Brown	83-		
(13)	911 555 757 75	Cover	/L	1	TARGA/CABRIO
		Lock pillar			
		Leather			
	911 555 757 75 8AH	Lobster	-78		
	911 555 757 75 5AH	Cork	-79		
	911 555 757 75 7AG	Black	-79		
	911 555 757 75 20B	Dark green	-80		
	911 555 757 75 2AP	Light green	-78		
	911 555 757 75 3NG	Brown	-82		
	911 555 757 75 3AG	Blue	-79		
	911 555 757 75 8AT	Light red	-79		
	911 555 757 75 1AG	Yellow	-79		
	911 555 757 75 9AG	White	-79		

Model: 911 78 Model life 1978>>1983

Pos	Part Number	Description	Remark	Qty	Model
	911 555 757 75 1AJ	Black	80-82		
	911 555 757 75 30B	Dark blue	80-82		
	911 555 757 75 50B	Beige	80-		
	911 555 757 75 30A	Blue	80		
	911 555 757 75 80B	Light red	80		
	911 555 757 75 10A	Yellow	80		
	911 555 757 75 99A	White	80		
	911 555 757 75 40D	Cork	80		
	911 555 757 75 80S	Can-can-red	81-		
	911 555 757 75 95S	Papyrus	81-		
	911 555 757 75 60S	Hannibal grey	81-		
	911 555 757 75 20S	Mint green	81-		
	911 555 757 75 6AD	Doric grey	80		
	911 555 757 75 2LB	Burgundy			
	911 555 757 75 LG7	Burgundy	83-		
	911 555 757 75 KZ4	Grey-beige	83-		
	911 555 757 75 8YD	Pearl white	83-		
	911 555 757 75 1VD	Champagne	83-		
	911 555 757 75 LG6	Dark green	83-		
	911 555 757 75 KZ2	Black	83-		
	911 555 757 75 KZ3	Blue	83-		
	911 555 757 75 KZ5	Brown	83-		
(13)	911 555 758 75	Cover	/R	1	TARGA/CABRIO
		Lock pillar			
		Leather			
	911 555 758 75 8AH	Lobster	-78		
	911 555 758 75 5AH	Cork	-79		
	911 555 758 75 7AG	Black	-79		
	911 555 758 75 20B	Dark green	-80		
	911 555 758 75 2AP	Light green	-78		
	911 555 758 75 3NG	Brown	-82		
	911 555 758 75 3AG	Blue	-79		
	911 555 758 75 8AT	Light red	-79		
	911 555 758 75 1AG	Yellow	-79		
	911 555 758 75 9AG	White	-79		
	911 555 758 75 1AJ	Black	80-82		
	911 555 758 75 30B	Dark blue	80-82		
	911 555 758 75 50B	Beige	80-		
	911 555 758 75 30A	Blue	80		
	911 555 758 75 80B	Light red	80		
	911 555 758 75 10A	Yellow	80		
	911 555 758 75 99A	White	80		
	911 555 758 75 40D	Cork	80		
	911 555 758 75 80S	Can-can-red	81-		
	911 555 758 75 95S	Papyrus	81-		
	911 555 758 75 60S	Hannibal grey	81-		
	911 555 758 75 20S	Mint green	81-		
	911 555 758 75 6AD	Doric grey	80		
	911 555 758 75 2LB	Burgundy			
	911 555 758 75 LG7	Burgundy	83-		
	911 555 758 75 KZ4	Grey-beige	83-		
	911 555 758 75 8YD	Pearl white	83-		
	911 555 758 75 1VD	Champagne	83-		
	911 555 758 75 LG6	Dark green	83-		
	911 555 758 75 KZ2	Black	83-		
	911 555 758 75 KZ3	Blue	83-		
	911 555 758 75 KZ5	Brown	83-		
(13)	901 555 023 01	Filler piece	/L	1	TARGA
(13)	901 555 024 01	Filler piece	/R	1	TARGA
(14)	911 555 091 00	Rear cover moulding	/L	1	COUPE
		Leatherette			
	911 555 091 00 8AU	Lobster	-78		
	911 555 091 00 5AU	Cork			

Model: 911 78 Model life 1978>>1983

Pos	Part Number	Description	Remark	Qty	Model
	911 555 091 00 7AU	Black	-82		
	911 555 091 00 4AU	Brown	79-82		
	911 555 091 00 3AU	Dark blue	80-82		
	911 555 091 00 5BC	Beige	80-		
	911 555 091 00 3MK	Burgundy	83-		
	911 555 091 00 05T	Black	83-		
	911 555 091 00 1HH	Blue	83-		
	911 555 091 00 4RB	Brown	83-		
14	911 555 092 00	Rear cover moulding Leatherette	/R	1	COUPE
	911 555 092 00 8AU	Lobster	-78		
	911 555 092 00 5AU	Cork			
	911 555 092 00 7AU	Black	-82		
	911 555 092 00 4AU	Brown	79-82		
	911 555 092 00 3AU	Dark blue	80-82		
	911 555 092 00 5BC	Beige	80-		
	911 555 092 00 3MK	Burgundy	83-		
	911 555 092 00 05T	Black	83-		
	911 555 092 00 1HH	Blue	83-		
	911 555 092 00 4RB	Brown	83-		
(14)	911 555 091 40	Rear cover moulding Leatherette	/L	1	TARGA
	911 555 091 40 8AU	Lobster	-78		
	911 555 091 40 5AU	Cork			
	911 555 091 40 7AU	Black	-82		
	911 555 091 40 4AU	Brown	79-82		
	911 555 091 40 3AU	Dark blue	80-82		
	911 555 091 40 5BC	Beige	80-		
	911 555 091 40 3MK	Burgundy	83-		
	911 555 091 40 05T	Black	83-		
	911 555 091 40 1HH	Blue	83-		
	911 555 091 40 4RB	Brown	83-		
(14)	911 555 092 40	Rear cover moulding Leatherette	/R	1	TARGA
	911 555 092 40 8AU	Lobster	-78		
	911 555 092 40 5AU	Cork			
	911 555 092 40 7AU	Black	-82		
	911 555 092 40 4AU	Brown	79-82		
	911 555 092 40 3AU	Dark blue	80-82		
	911 555 092 40 5BC	Beige	80-		
	911 555 092 40 3MK	Burgundy	83-		
	911 555 092 40 05T	Black	83-		
	911 555 092 40 1HH	Blue	83-		
	911 555 092 40 4RB	Brown	83-		
(14)	911 555 091 70	Rear cover moulding Leather	/L	1	COUPE
	911 555 091 70 8AH	Lobster	-78		
	911 555 091 70 5AH	Cork	-79		
	911 555 091 70 7AG	Black	-79		
	911 555 091 70 20B	Dark green			
	911 555 091 70 3NG	Brown	-82		
	911 555 091 70 3AG	Blue	-79		
	911 555 091 70 8AT	Light red	-79		
	911 555 091 70 1AJ	Black	80-82		
	911 555 091 70 30B	Dark blue	80-82		
	911 555 091 70 30A	Blue	80		
	911 555 091 70 40D	Cork	80		
	911 555 091 70 60S	Hannibal grey	81-		
	911 555 091 70 20S	Mint green	81-		
	911 555 091 70 6AD	Doric grey	80		
	911 555 091 70 2LB	Burgundy			
	911 555 091 70 LG7	Burgundy	83-		
	911 555 091 70 LG6	Dark green	83-		

Model: 911 78 Model life 1978>>1983

Pos	Part Number	Description	Remark	Qty	Model
14	911 555 091 70 KZ2	Black	83-	1	COUPE
	911 555 091 70 KZ3	Blue	83-		
	911 555 091 70 KZ5	Brown	83-		
	911 555 092 70	Rear cover moulding Leather	/R		
	911 555 092 70 8AH	Lobster	-78		
	911 555 092 70 5AH	Cork	-79		
	911 555 092 70 7AG	Black	-79		
	911 555 092 70 20B	Dark green			
	911 555 092 70 3NG	Brown	-82		
	911 555 092 70 3AG	Blue	-79		
	911 555 092 70 8AT	Light red	-79		
	911 555 092 70 1AJ	Black	80-82		
	911 555 092 70 30B	Dark blue	80-82		
	911 555 092 70 30A	Blue	80		
	911 555 092 70 40D	Cork	80		
	911 555 092 70 60S	Hannibal grey	81-		
	911 555 092 70 20S	Mint green	81-		
	911 555 092 70 6AD	Doric grey	80		
	911 555 092 70 2LB	Burgundy			
	911 555 092 70 LG7	Burgundy	83-		
	911 555 092 70 LG6	Dark green	83-		
911 555 092 70 KZ2	Black	83-			
911 555 092 70 KZ3	Blue	83-			
911 555 092 70 KZ5	Brown	83-			
(14)	911 555 091 75	Rear cover moulding Leather	/L	1	TARGA
	911 555 091 75 8AH	Lobster	-78	1	TARGA
	911 555 091 75 5AH	Cork	-79		
	911 555 091 75 7AG	Black	-79		
	911 555 091 75 20B	Dark green			
	911 555 091 75 3NG	Brown	-82		
	911 555 091 75 3AG	Blue	-79		
	911 555 091 75 8AT	Light red	-79		
	911 555 091 75 1AJ	Black	80-82		
	911 555 091 75 30B	Dark blue	80-82		
	911 555 091 75 30A	Blue	80		
	911 555 091 75 40D	Cork	80		
	911 555 091 75 60S	Hannibal grey	81-		
	911 555 091 75 20S	Mint green	81-		
	911 555 091 75 6AD	Doric grey	80		
	911 555 091 75 2LB	Burgundy			
	911 555 091 75 LG7	Burgundy	83-		
	911 555 091 75 LG6	Dark green	83-		
	911 555 091 75 KZ2	Black	83-		
	911 555 091 75 KZ3	Blue	83-		
	911 555 091 75 KZ5	Brown	83-		
	(14)	911 555 092 75	Rear cover moulding Leather		
	911 555 092 75 8AH	Lobster	-78	1	TARGA
	911 555 092 75 5AH	Cork	-79		
	911 555 092 75 7AG	Black	-79		
	911 555 092 75 20B	Dark green			
	911 555 092 75 3NG	Brown	-82		
	911 555 092 75 3AG	Blue	-79		
	911 555 092 75 8AT	Light red	-79		
	911 555 092 75 1AJ	Black	80-82		
	911 555 092 75 30B	Dark blue	80-82		
	911 555 092 75 30A	Blue	80		
	911 555 092 75 40D	Cork	80		
	911 555 092 75 60S	Hannibal grey	81-		
	911 555 092 75 20S	Mint green	81-		
	911 555 092 75 6AD	Doric grey	80		

Model: 911 78

Model life 1978>>1983

Pos	Part Number	Description	Remark	Qty	Model
	911 555 092 75 2LB	Burgundy			
	911 555 092 75 LG7	Burgundy	83-		
	911 555 092 75 LG6	Dark green	83-		
	911 555 092 75 KZ2	Black	83-		
	911 555 092 75 KZ3	Blue	83-		
	911 555 092 75 KZ5	Brown	83-		
15	999 591 338 02	Speed nut		4	
15	999 591 460 01	Speed nut		4	
16	900 145 071 07	Tapping screw B 3,5 X 13		6	
17	999 591 116 07	Cone washer		6	
(18)	901 552 871 40	Cover		2	
(18)	477 857 375 A	Support for seatbelt	(AUS)	2	
	477 857 375 A 01C	Black			
19	901 552 872 20	Coat hook		2	
20	900 250 007 02	Tapping screw AM 5 X 12		2	

Model: 911 78

Model life 1978>>1983

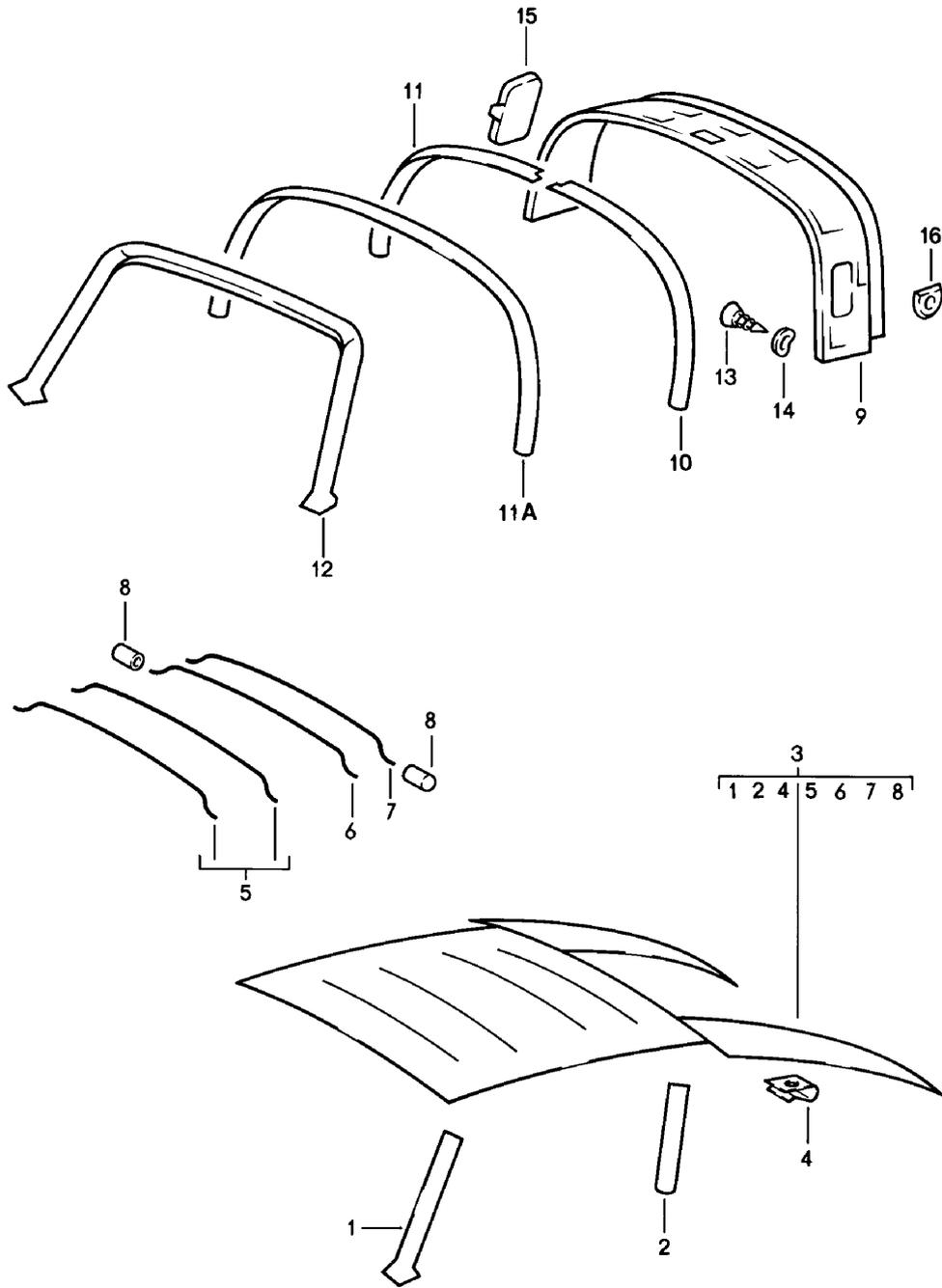

Model: 911 78 Model life 1978>>1983

Pos	Part Number	Description	Remark	Qty	Model
1	911 555 507 00	Interior equipment Roof Lining Windscreen frame part	/L	1	COUPE
	911 555 507 00 702	Black			
	911 555 507 00 4AU	Brown	-82		
	911 555 507 00 30B	Dark blue	-82		
	911 555 507 00 2LB	Burgundy			
	911 555 507 00 1HH	Blue	83-		
	911 555 507 00 3MX	Burgundy	83-		
	911 555 507 00 5FX	Grey-beige	83-		
	911 555 507 00 4RB	Brown	83-		
	(1) 911 555 508 00	Lining Windscreen frame part	/R		
911 555 508 00 702	Black				
911 555 508 00 4AU	Brown	-82			
911 555 508 00 30B	Dark blue	-82			
911 555 508 00 2LB	Burgundy				
911 555 508 00 1HH	Blue	83-			
911 555 508 00 3MX	Burgundy	83-			
911 555 508 00 5FX	Grey-beige	83-			
911 555 508 00 4RB	Brown	83-			
2	911 555 505 01	Lining Door pillar	/L	1	COUPE
911 555 505 01 702	Black				
911 555 505 01 4AU	Brown	-82			
911 555 505 01 30B	Dark blue	-82			
911 555 505 01 2LB	Burgundy				
911 555 505 01 1HH	Blue	83-			
911 555 505 01 3MX	Burgundy	83-			
911 555 505 01 5FX	Grey-beige	83-			
911 555 505 01 4RB	Brown	83-			
(2) 911 555 506 01	Lining Door pillar	/R	1		
911 555 506 01 702	Black				
911 555 506 01 4AU	Brown	-82			
911 555 506 01 30B	Dark blue	-82			
911 555 506 01 2LB	Burgundy				
911 555 506 01 1HH	Blue	83-			
911 555 506 01 3MX	Burgundy	83-			
911 555 506 01 5FX	Grey-beige	83-			
911 555 506 01 4RB	Brown	83-			
3	911 555 055 05	Roof lining without POS.1-8 for cars without Sunroof			1
911 555 055 05 700	Black				
911 555 055 05 500	Beige				
911 555 055 05 3AD	Dark blue	-82			
911 555 055 05 21S	Brown	-82			
911 555 055 05 2LB	Burgundy				
911 555 055 05 8LC	Burgundy	83-			
911 555 055 05 7FC	Grey-beige	83-			
911 555 055 05 1HH	Blue	83-			
911 555 055 05 4RB	Brown	83-			
(3) 911 555 055 15	Roof lining for cars with Sunroof		1	COUPE M650	
911 555 055 15 700	Black				
911 555 055 15 500	Beige				
911 555 055 15 3AD	Dark blue	-82			

Model: 911 78 Model life 1978>>1983

Pos	Part Number	Description	Remark	Qty	Model
	911 555 055 15 21S	Brown	-82		
	911 555 055 15 2LB	Burgundy			
	911 555 055 15 8LC	Burgundy	83-		
	911 555 055 15 7FC	Grey-beige	83-		
	911 555 055 15 1HH	Blue	83-		
	911 555 055 15 4RB	Brown	83-		
(3)	911 555 055 13	Roof lining	-82	1	COUPE M650
		for cars with Sunroof			
(3)	911 555 055 14	Brown Roof lining	-82	1	COUPE M650
		for cars with Sunroof			
		Dark blue			
4	999 591 336 01	Fastening clamp	/H	5	COUPE
(4)	999 591 342 02	Clamp	/V	5	COUPE
(4)	999 591 342 03	Clamp	/V	5	COUPE
5	901 555 511 20	Transverse strut 1 + 2		2	COUPE
6	901 555 512 20	Transverse strut 3		1	COUPE
7	901 555 513 20	Transverse strut 4		1	COUPE
8	644 555 515 00	Rubber profile		8	COUPE
9	911 565 019 40	Interior lining		1	TARGA
	911 565 019 40 702	Black			
10	911 565 513 40	Padding	/L	1	TARGA
11	911 565 514 40	Padding	/R	1	TARGA
11A	901 565 511 40	Cover		1	TARGA
		Padding			
12	901 555 901 40	Lining	/V	1	TARGA/CABRIO
		Windscreen frame part			
	901 555 901 40 702	Black			
13	900 145 038 07	Oval-head sheetmetal screw B 3,5 X 16		4	TARGA
14	999 591 102 17	Washer 3,5		4	TARGA
14	999 591 102 1H	Washer 3,5		4	TARGA
(15)	911 565 157 40	Bleeding	/L	1	TARGA
15	911 565 158 40	Bleeding	/R	1	TARGA
16	911 565 132 00	Filler piece		2	TARGA

Model: 911 78

Model life 1978>>1983

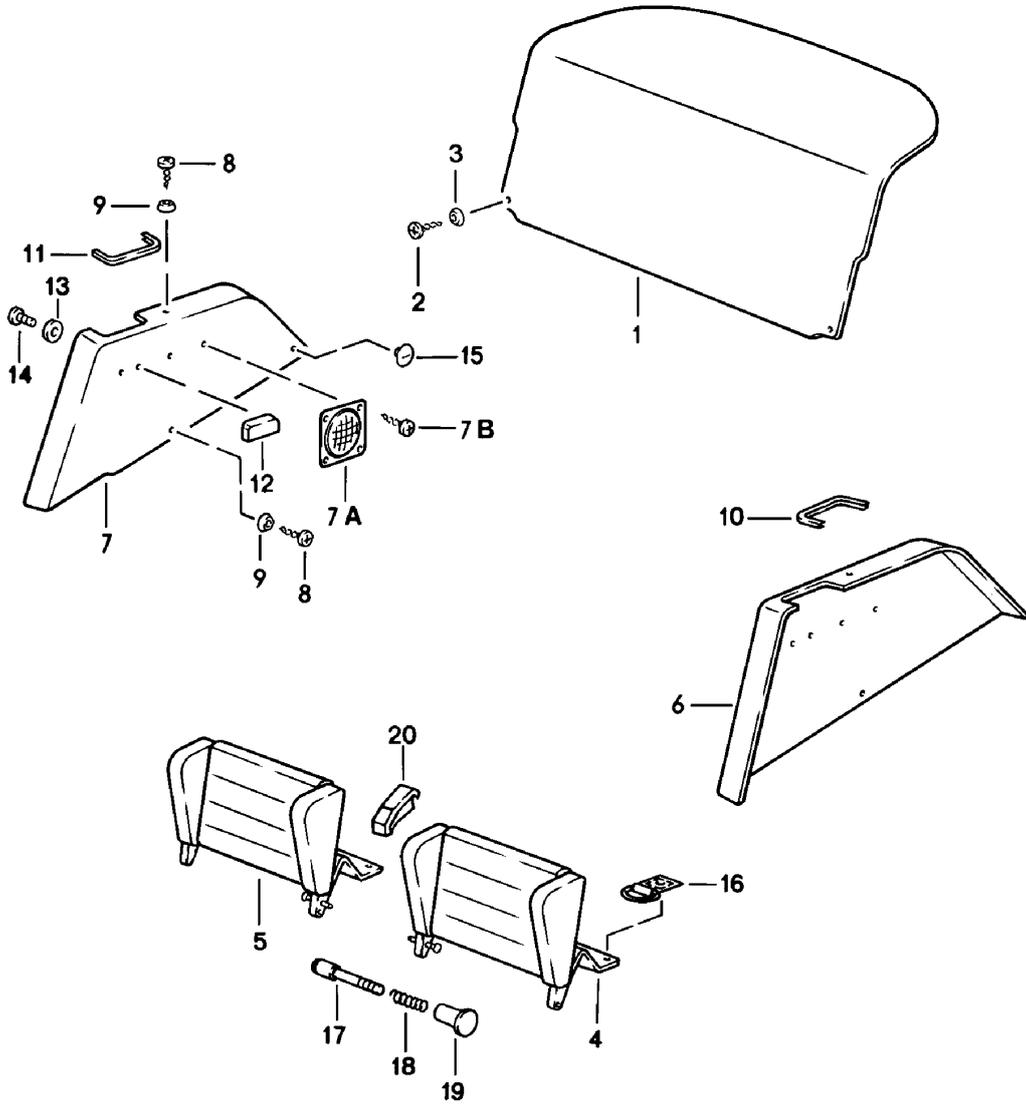

Model: 911 78 Model life 1978>>1983

Pos	Part Number	Description	Remark	Qty	Model
		Interior equipment			CABRIO
1	911 555 075 60	Rear Back wall lining Carpet		1	
	911 555 075 60 70E	Black			
	911 555 075 60 30B	Blue			
	911 555 075 60 40E	Brown			
	911 555 075 60 80E	Burgundy			
	911 555 075 60 60A	Grey			
	911 555 075 60 2FL	Grey-beige			
2	900 145 072 07	Tapping screw B 3,5 X 22		2	
3	999 591 102 17	Washer 3,5		2	
3	999 591 102 1H	Washer 3,5		2	
(4)	911 522 017 60	Back seat backrest Leatherette	/L	1	
	911 522 017 60 43S	Black			
	911 522 017 60 1HH	Blue			
	911 522 017 60 4RB	Brown			
	911 522 017 60 3MK	Burgundy			
	911 522 017 60 4FK	Grey-beige			
(4)	911 522 017 62	Back seat backrest Leather	/L	1	
	911 522 017 62 KZ2	Black			
	911 522 017 62 KZ3	Blue			
	911 522 017 62 KZ5	Brown			
	911 522 017 62 LG7	Burgundy			
	911 522 017 62 KZ4	Grey-beige			
	911 522 017 62 KZ6	Can-can-red	83-		
	911 522 017 62 LG4	Pearl white	83-		
	911 522 017 62 LG5	Champagne	83-		
	911 522 017 62 LG6	Dark green	83-		
(5)	911 522 018 60	Back seat backrest Leatherette	/R	1	
	911 522 018 60 43S	Black			
	911 522 018 60 1HH	Blue			
	911 522 018 60 4RB	Brown			
	911 522 018 60 3MK	Burgundy			
	911 522 018 60 4FK	Grey-beige			
(5)	911 522 018 62	Back seat backrest Leather	/R	1	
	911 522 018 62 KZ2	Black			
	911 522 018 62 KZ3	Blue			
	911 522 018 62 KZ5	Brown			
	911 522 018 62 LG7	Burgundy			
	911 522 018 62 KZ4	Grey-beige			
	911 522 018 62 KZ6	Can-can-red	83-		
	911 522 018 62 LG4	Pearl white	83-		
	911 522 018 62 LG5	Champagne	83-		
	911 522 018 62 LG6	Dark green	83-		
6	911 555 071 60	Side trim panel Carpet	/L	1	
	911 555 071 60 70E	Black			
	911 555 071 60 30B	Blue			
	911 555 071 60 40E	Brown			
	911 555 071 60 80E	Burgundy			
	911 555 071 60 2FL	Grey-beige			
	911 555 071 60 6JD	Dark green	83-		
	911 555 071 60 1VD	Champagne	83-		
(6)	911 555 071 61	Side trim panel with	/L	1	

Model: 911 78 Model life 1978>>1983

Pos	Part Number	Description	Remark	Qty	Model
		Loudspeaker			
		Carpet			
	911 555 071 61 70E	Black			
	911 555 071 61 30B	Blue			
	911 555 071 61 40E	Brown			
	911 555 071 61 80E	Burgundy			
	911 555 071 61 2FL	Grey-beige			
	911 555 071 61 6JD	Dark green	83-		
	911 555 071 61 1VD	Champagne	83-		
7	911 555 072 60	Side trim panel	/R	1	
		Carpet			
	911 555 072 60 70E	Black			
	911 555 072 60 30B	Blue			
	911 555 072 60 40E	Brown			
	911 555 072 60 80E	Burgundy			
	911 555 072 60 2FL	Grey-beige			
	911 555 072 60 6JD	Dark green	83-		
	911 555 072 60 1VD	Champagne	83-		
(7)	911 555 072 61	Side trim panel	/R	1	
		with			
		Loudspeaker			
		Carpet			
	911 555 072 61 70E	Black			
	911 555 072 61 30B	Blue			
	911 555 072 61 40E	Brown			
	911 555 072 61 80E	Burgundy			
	911 555 072 61 2FL	Grey-beige			
	911 555 072 61 6JD	Dark green	83-		
	911 555 072 61 1VD	Champagne	83-		
7A	928 645 423 00	Loudspeaker grille		2	
7B	900 143 132 07	Tapping screw		8	
		B 3,9 X 16			
8	N 014 093 3	Oval-head sheetmetal screw		4	
		B 4,2 X 13			
9	999 591 116 07	Cone washer		4	
10	911 555 417 60	Rosette	/L	1	
11	911 555 418 60	Rosette	/R	1	
12	477 857 375 A	Support for seatbelt		2	
	477 857 375 A 01C	Black			
	477 857 375 A 89S	Brown			
13	N 011 665 3	Washer		4	
		B 5,3			
13	N 011 665 16	Washer		4	
		B 5,3			
14	900 146 003 02	Oval-head screw		4	
		M 5 X 10			
15	N 900 685 01	Push button		2	
16	911 561 493 00	Leather loop		2	
17	911 522 229 00	Bolt		2	
18	911 522 233 00	Spring		2	
19	911 522 231 00	Knob		2	
20	911 522 561 60	Intermediate piece		1	

Model: 911 78

Model life 1978>>1983

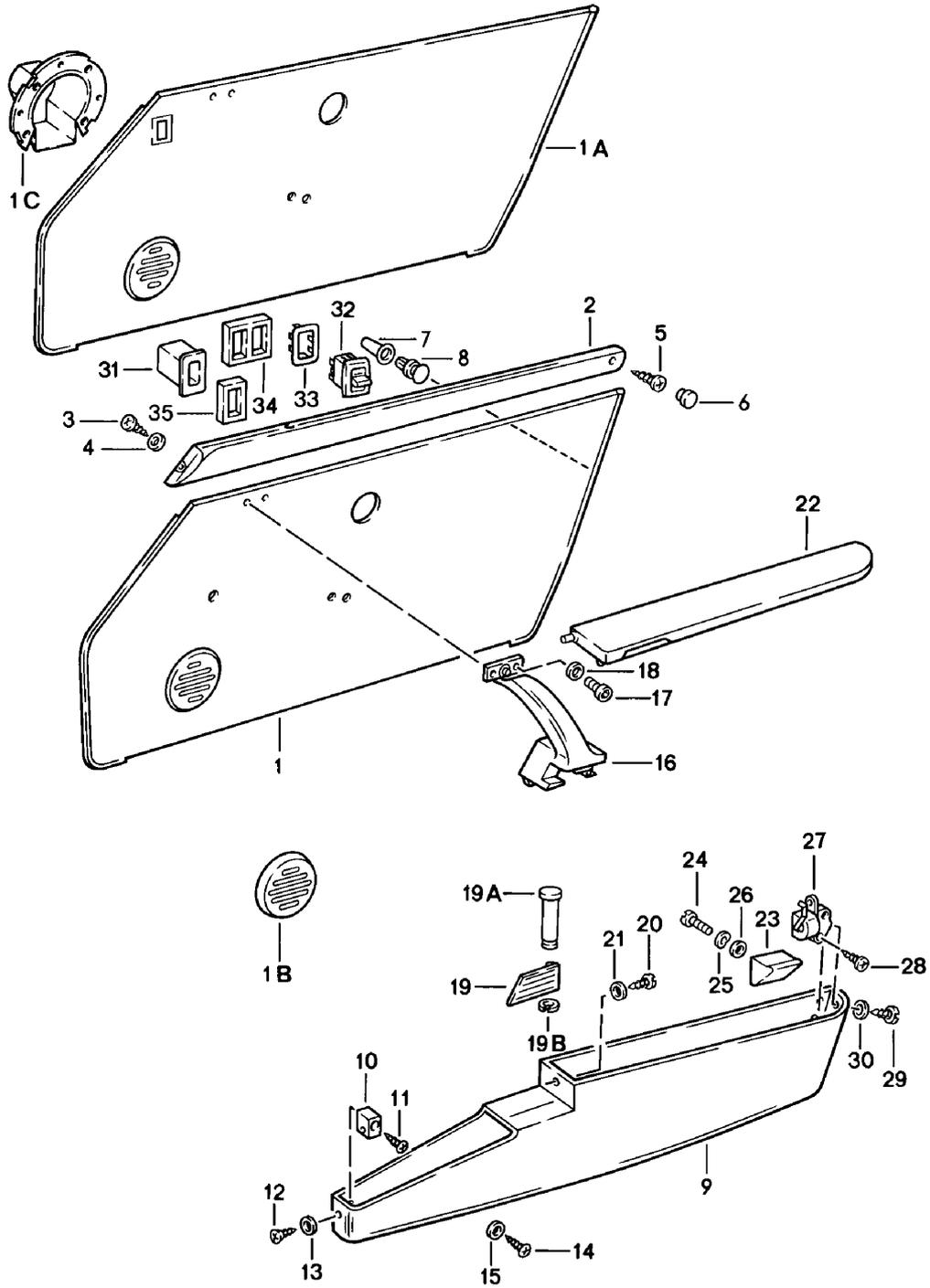

Model: 911 78 Model life 1978>>1983

Pos	Part Number	Description	Remark	Qty	Model
		Interior equipment			
		Doors			
(1)	911 555 031 28	Door panel	/L -79	1	SC
		Leatherette			
	911 555 031 28 8AU	Lobster	-78		
	911 555 031 28 5AU	Cork			
	911 555 031 28 7AU	Black			
	911 555 031 28 4AU	Brown	79		
1	911 555 032 28	Door panel	/R -79	1	SC
		Leatherette			
	911 555 032 28 8AU	Lobster	-78		
	911 555 032 28 5AU	Cork			
	911 555 032 28 7AU	Black			
	911 555 032 28 4AU	Brown	79		
(1)	911 555 031 31	Door panel	/L -78	1	SC
		Pin stripe velour			
	911 555 031 31 8AK	Lobster			
	911 555 031 31 5AK	Cork			
	911 555 031 31 7AK	Black			
(1)	911 555 032 31	Door trim panel	/R -78	1	SC
		Pin stripe velour			
	911 555 032 31 8AK	Lobster			
	911 555 032 31 5AK	Cork			
	911 555 032 31 7AK	Black			
(1)	911 555 031 31	Door panel	/L -78	1	SC
		Tartan cloth			
	911 555 031 31 8AB	Red-blue			
	911 555 031 31 2AC	Green-blue			
	911 555 031 31 4AD	Brown-beige			
(1)	911 555 032 31	Door trim panel	/R -78	1	SC
		Tartan cloth			
	911 555 032 31 8AB	Red-blue			
	911 555 032 31 2AC	Green-blue			
	911 555 032 31 4AD	Brown-beige			
(1)	911 555 031 87	Door trim panel	/L -79	1	SC
		Leather			
	911 555 031 87 8AH	Lobster	-78		
	911 555 031 87 5AH	Cork			
	911 555 031 87 7AG	Black			
	911 555 031 87 20B	Dark green			
	911 555 031 87 2AP	Light green	-78		
	911 555 031 87 40A	Brown			
	911 555 031 87 3AG	Blue			
	911 555 031 87 8AT	Light red			
	911 555 031 87 1AG	Yellow			
	911 555 031 87 9AG	White			
1	911 555 032 87	Door trim panel	/R -79	1	SC
		Leather			
	911 555 032 87 8AH	Lobster	-78		
	911 555 032 87 5AH	Cork			
	911 555 032 87 7AG	Black			
	911 555 032 87 20B	Dark green			
	911 555 032 87 2AP	Light green	-78		
	911 555 032 87 40A	Brown			
	911 555 032 87 3AG	Blue			
	911 555 032 87 8AT	Light red			
	911 555 032 87 1AG	Yellow			
	911 555 032 87 9AG	White			
(1A)	911 555 031 29	Door panel	/LL /L -82	1	SC
		Leatherette			
	911 555 031 29 8AU	Lobster	-78		
	911 555 031 29 5AU	Cork	-79		
	911 555 031 29 7AU	Black			

Model: 911 78 Model life 1978>>1983

Pos	Part Number	Description	Remark	Qty	Model
	911 555 031 29 4AU	Brown	79-82		
	911 555 031 29 3AU	Dark blue	80-82		
	911 555 031 29 5BC	Beige	80-82		
(1A)	911 555 031 30	Door trim panel Leatherette	/RL /L -82	1	SC
	911 555 031 30 8AU	Lobster	-78		
	911 555 031 30 5AU	Cork	-79		
	911 555 031 30 7AU	Black			
	911 555 031 30 4AU	Brown	79-82		
	911 555 031 30 3AU	Dark blue	80-82		
	911 555 031 30 5BC	Beige	80-82		
1A	911 555 032 29	Door trim panel Leatherette	/LL /R -82	1	SC
	911 555 032 29 8AU	Lobster	-78		
	911 555 032 29 5AU	Cork	-79		
	911 555 032 29 7AU	Black			
	911 555 032 29 4AU	Brown	79-82		
	911 555 032 29 3AU	Dark blue	80-82		
	911 555 032 29 5BC	Beige	80-82		
(1A)	911 555 032 30	Door panel Leatherette	/RL /R -82	1	SC
	911 555 032 30 8AU	Lobster	-78		
	911 555 032 30 5AU	Cork	-79		
	911 555 032 30 7AU	Black			
	911 555 032 30 4AU	Brown	79-82		
	911 555 032 30 3AU	Dark blue	80-82		
	911 555 032 30 5BC	Beige	80-82		
(1A)	911 555 031 34	Door trim panel Leatherette	/LL /L 83-	1	SC
	911 555 031 34 3MK	Burgundy			
	911 555 031 34 4FK	Grey-beige			
	911 555 031 34 05T	Black			
	911 555 031 34 1HH	Blue			
	911 555 031 34 4RB	Brown			
(1A)	911 555 031 35	Door trim panel Leatherette	/RL /L 83-	1	SC
	911 555 031 35 3MK	Burgundy			
	911 555 031 35 4FK	Grey-beige			
	911 555 031 35 05T	Black			
	911 555 031 35 1HH	Blue			
	911 555 031 35 4RB	Brown			
1A	911 555 032 34	Door trim panel Leatherette	/LL /R 83-	1	SC
	911 555 032 34 3MK	Burgundy			
	911 555 032 34 4FK	Grey-beige			
	911 555 032 34 05T	Black			
	911 555 032 34 1HH	Blue			
	911 555 032 34 4RB	Brown			
(1A)	911 555 032 35	Door trim panel Leatherette	/RL /R 83-	1	SC
	911 555 032 35 3MK	Burgundy			
	911 555 032 35 4FK	Grey-beige			
	911 555 032 35 05T	Black			
	911 555 032 35 1HH	Blue			
	911 555 032 35 4RB	Brown			
(1A)	911 555 931 40	Door trim panel Leatherette	/L 83-	1	SC
	911 555 931 40 3MK	Burgundy			
	911 555 931 40 4FK	Grey-beige			
	911 555 931 40 05T	Black			
	911 555 931 40 1HH	Blue			
	911 555 931 40 4RB	Brown			
(1A)	911 555 932 40	Door trim panel	/R 83-	1	SC

Model: 911 78 Model life 1978>>1983

Pos	Part Number	Description	Remark	Qty	Model
		Leatherette			
	911 555 932 40 3MK	Burgundy			
	911 555 932 40 4FK	Grey-beige			
	911 555 932 40 05T	Black			
	911 555 932 40 1HH	Blue			
	911 555 932 40 4RB	Brown			
(1A)	911 555 031 32	Door trim panel	/LL /L 78	1	
		Pin stripe velour			
	911 555 031 32 8AK	Lobster			
	911 555 031 32 5AK	Cork			
	911 555 031 32 7AK	Black			
(1A)	911 555 031 33	Door panel	/RL /L 78	1	
		Pin stripe velour			
	911 555 031 33 8AK	Lobster			
	911 555 031 33 5AK	Cork			
	911 555 031 33 7AK	Black			
1A	911 555 032 32	Door trim panel	/LL /R 78	1	
		Pin stripe velour			
	911 555 032 32 8AK	Lobster			
	911 555 032 32 5AK	Cork			
	911 555 032 32 7AK	Black			
(1A)	911 555 032 33	Door trim panel	/RL /R 78	1	
		Pin stripe velour			
	911 555 032 33 8AK	Lobster			
	911 555 032 33 5AK	Cork			
	911 555 032 33 7AK	Black			
(1A)	911 555 031 32	Door trim panel	/LL /L 78	1	
		Tartan cloth			
	911 555 031 32 8AB	Red-blue			
	911 555 031 32 2AC	Green-blue			
	911 555 031 32 4AD	Brown-beige			
(1A)	911 555 031 33	Door panel	/RL /L 78	1	
		Tartan cloth			
	911 555 031 33 8AB	Red-blue			
	911 555 031 33 2AC	Green-blue			
	911 555 031 33 4AD	Brown-beige			
1A	911 555 032 32	Door trim panel	/LL /R 78	1	
		Tartan cloth			
	911 555 032 32 8AB	Red-blue			
	911 555 032 32 2AC	Green-blue			
	911 555 032 32 4AD	Brown-beige			
(1A)	911 555 032 33	Door trim panel	/RL /R 78	1	
		Tartan cloth			
	911 555 032 33 8AB	Red-blue			
	911 555 032 33 2AC	Green-blue			
	911 555 032 33 4AD	Brown-beige			
(1A)	911 555 031 32	Door trim panel	/LL /L 78	1	
		Stripe design			M403
	911 555 031 32 9LA	Burgundy			
(1A)	911 555 031 33	Door panel	/RL /L 78	1	
		Stripe design			M403
	911 555 031 33 9LA	Burgundy			
1A	911 555 032 32	Door trim panel	/LL /R 78	1	
		Stripe design			M403
	911 555 032 32 9LA	Burgundy			
(1A)	911 555 032 33	Door trim panel	/RL /R 78	1	
		Stripe design			M403
	911 555 032 33 9LA	Burgundy			
(1A)	930 555 031 72	Door trim panel	/LL /L -82	1	
		Leather			
	930 555 031 72 8AH	Lobster	-78		
	930 555 031 72 5AH	Cork	-79		
	930 555 031 72 7AG	Black	-79		

Model: 911 78 Model life 1978>>1983

Pos	Part Number	Description	Remark	Qty	Model
	930 555 031 72 20B	Dark green	-79		
	930 555 031 72 2AP	Light green	-78		
	930 555 031 72 3NG	Brown			
	930 555 031 72 3AG	Blue	-79		
	930 555 031 72 8AT	Light red	-79		
	930 555 031 72 1AG	Yellow	-79		
	930 555 031 72 9AG	White	-79		
	930 555 031 72 1AJ	Black	80-		
	930 555 031 72 30B	Dark blue	80-		
	930 555 031 72 50B	Beige	80-		
	930 555 031 72 30A	Blue	80		
	930 555 031 72 80B	Light red	80		
	930 555 031 72 10A	Yellow	80		
	930 555 031 72 99A	White	80		
	930 555 031 72 40D	Cork	80		
	930 555 031 72 80S	Can-can-red	81-		
	930 555 031 72 95S	Papyrus	81-		
	930 555 031 72 60S	Hannibal grey	81-		
	930 555 031 72 20S	Mint green	81-		
	930 555 031 72 6AD	Doric grey	80		
(1A)	930 555 031 73	Door trim panel Leather	/RL /L -82	1	
	930 555 031 73 8AH	Lobster	-78		
	930 555 031 73 5AH	Cork	-79		
	930 555 031 73 7AG	Black	-79		
	930 555 031 73 20B	Dark green	-79		
	930 555 031 73 2AP	Light green	-78		
	930 555 031 73 3NG	Brown			
	930 555 031 73 3AG	Blue	-79		
	930 555 031 73 8AT	Light red	-79		
	930 555 031 73 1AG	Yellow	-79		
	930 555 031 73 9AG	White	-79		
	930 555 031 73 1AJ	Black	80-		
	930 555 031 73 30B	Dark blue	80-		
	930 555 031 73 50B	Beige	80-		
	930 555 031 73 30A	Blue	80		
	930 555 031 73 80B	Light red	80		
	930 555 031 73 10A	Yellow	80		
	930 555 031 73 99A	White	80		
	930 555 031 73 40D	Cork	80		
	930 555 031 73 80S	Can-can-red	81-		
	930 555 031 73 95S	Papyrus	81-		
	930 555 031 73 60S	Hannibal grey	81-		
	930 555 031 73 20S	Mint green	81-		
	930 555 031 73 6AD	Doric grey	80		
1A	930 555 032 72	Door trim panel Leather	/LL /R -82	1	
	930 555 032 72 8AH	Lobster	-78		
	930 555 032 72 5AH	Cork	-79		
	930 555 032 72 7AG	Black	-79		
	930 555 032 72 20B	Dark green	-79		
	930 555 032 72 2AP	Light green	-78		
	930 555 032 72 3NG	Brown			
	930 555 032 72 3AG	Blue	-79		
	930 555 032 72 8AT	Light red	-79		
	930 555 032 72 1AG	Yellow	-79		
	930 555 032 72 9AG	White	-79		
	930 555 032 72 1AJ	Black	80-		
	930 555 032 72 30B	Dark blue	80-		
	930 555 032 72 50B	Beige	80-		
	930 555 032 72 30A	Blue	80		
	930 555 032 72 80B	Light red	80		
	930 555 032 72 10A	Yellow	80		

Model: 911 78 Model life 1978>>1983

Pos	Part Number	Description	Remark	Qty	Model
	930 555 032 72 99A	White	80		
	930 555 032 72 40D	Cork	80		
	930 555 032 72 80S	Can-can-red	81-		
	930 555 032 72 95S	Papyrus	81-		
	930 555 032 72 60S	Hannibal grey	81-		
	930 555 032 72 20S	Mint green	81-		
	930 555 032 72 6AD	Doric grey	80		
(1A)	930 555 032 73	Door trim panel	/RL /R -82	1	
		Leather			
	930 555 032 73 8AH	Lobster	-78		
	930 555 032 73 5AH	Cork	-79		
	930 555 032 73 7AG	Black	-79		
	930 555 032 73 20B	Dark green	-79		
	930 555 032 73 2AP	Light green	-78		
	930 555 032 73 3NG	Brown			
	930 555 032 73 3AG	Blue	-79		
	930 555 032 73 8AT	Light red	-79		
	930 555 032 73 1AG	Yellow	-79		
	930 555 032 73 9AG	White	-79		
	930 555 032 73 1AJ	Black	80-		
	930 555 032 73 30B	Dark blue	80-		
	930 555 032 73 50B	Beige	80-		
	930 555 032 73 30A	Blue	80		
	930 555 032 73 80B	Light red	80		
	930 555 032 73 10A	Yellow	80		
	930 555 032 73 99A	White	80		
	930 555 032 73 40D	Cork	80		
	930 555 032 73 80S	Can-can-red	81-		
	930 555 032 73 95S	Papyrus	81-		
	930 555 032 73 60S	Hannibal grey	81-		
	930 555 032 73 20S	Mint green	81-		
	930 555 032 73 6AD	Doric grey	80		
(1A)	930 555 031 74	Door trim panel	/LL /L 83-	1	
		Leather			
	930 555 031 74 LG7	Burgundy			
	930 555 031 74 KZ4	Grey-beige			
	930 555 031 74 LG6	Dark green			
	930 555 031 74 KZ2	Black			
	930 555 031 74 KZ3	Blue			
	930 555 031 74 KZ5	Brown			
	930 555 031 74 KZ6	Can-can-red			
	930 555 031 74 LG4	Pearl white			
	930 555 031 74 LG5	Champagne			
(1A)	930 555 031 75	Door trim panel	/RL /L 83-	1	
		Leather			
	930 555 031 75 LG7	Burgundy			
	930 555 031 75 KZ4	Grey-beige			
	930 555 031 75 LG6	Dark green			
	930 555 031 75 KZ2	Black			
	930 555 031 75 KZ3	Blue			
	930 555 031 75 KZ5	Brown			
	930 555 031 75 KZ6	Can-can-red			
	930 555 031 75 LG4	Pearl white			
	930 555 031 75 LG5	Champagne			
1A	930 555 032 74	Door trim panel	/LL /R 83-	1	
		Leather			
	930 555 032 74 LG7	Burgundy			
	930 555 032 74 KZ4	Grey-beige			
	930 555 032 74 LG6	Dark green			
	930 555 032 74 KZ2	Black			
	930 555 032 74 KZ3	Blue			
	930 555 032 74 KZ5	Brown			
	930 555 032 74 KZ6	Can-can-red			

Model: 911 78 Model life 1978>>1983

Pos	Part Number	Description	Remark	Qty	Model	
(1A)	930 555 032 74 LG4	Pearl white				
	930 555 032 74 LG5	Champagne				
	930 555 032 75	Door trim panel	/RL /R 83-	1		
		Leather				
	930 555 032 75 LG7	Burgundy				
	930 555 032 75 KZ4	Grey-beige				
	930 555 032 75 LG6	Dark green				
	930 555 032 75 KZ2	Black				
	930 555 032 75 KZ3	Blue				
	930 555 032 75 KZ5	Brown				
(1A)	930 555 032 75 KZ6	Can-can-red				
	930 555 032 75 LG4	Pearl white				
	930 555 032 75 LG5	Champagne				
	911 555 931 50	Door trim panel	/L	1		
		Leather				
	911 555 931 50 LG7	Burgundy				
	911 555 931 50 KZ4	Grey-beige				
	911 555 931 50 LG6	Dark green				
	911 555 931 50 KZ2	Black				
	911 555 931 50 KZ3	Blue				
(1A)	911 555 931 50 KZ5	Brown				
	911 555 931 50 KZ6	Can-can-red				
	911 555 931 50 LG4	Pearl white				
	911 555 931 50 LG5	Champagne				
	911 555 932 50	Door trim panel	/R	1		
		Leather				
	911 555 932 50 LG7	Burgundy				
	911 555 932 50 KZ4	Grey-beige				
	911 555 932 50 LG6	Dark green				
	911 555 932 50 KZ2	Black				
1B	911 555 932 50 KZ3	Blue				
	911 555 932 50 KZ5	Brown				
	911 555 932 50 KZ6	Can-can-red				
	911 555 932 50 LG4	Pearl white				
	911 555 932 50 LG5	Champagne				
	911 555 013 00	Cover	-82	2		
	(1B)	911 555 013 01	Loudspeaker grille	83-	2	
	-	999 507 226 01	Clamping washer		6	
	1C	911 555 217 00	Housing	83-	2	
	(2)	911 555 083 45	Cover strip	/LL /L	1	SC
		Leatherette				
911 555 083 45 8AE		Lobster	-78			
911 555 083 45 5AE		Cork				
911 555 083 45 7AE		Black				
911 555 083 45 21S		Brown	-79			
911 555 083 45 30B		Blue	80-			
911 555 083 45 3MX		Burgundy	83-			
911 555 083 45 4RB		Brown	83-			
2		911 555 084 46	Cover strip	/LL /R	1	SC
(2)		Leatherette				
	911 555 084 46 8AE	Lobster	-78			
	911 555 084 46 5AE	Cork				
	911 555 084 46 7AE	Black				
	911 555 084 46 21S	Brown	-79			
	911 555 084 46 30B	Blue	80-			
	911 555 084 46 3MX	Burgundy	83-			
	911 555 084 46 4RB	Brown	83-			
	911 555 083 47	Cover strip	/LL /L	1	SC	
		Leatherette				
(2)	911 555 083 47 8AE	Lobster	-78			
	911 555 083 47 5AE	Cork				
	911 555 083 47 7AE	Black				
	911 555 083 47 21S	Brown	-79			

Model: 911 78 Model life 1978>>1983

Pos	Part Number	Description	Remark	Qty	Model
2	911 555 083 47 30B	Dark blue	80-	1	SC
	911 555 083 47 3MX	Burgundy	83-		
	911 555 083 47 4RB	Brown	83-		
	911 555 084 48	Cover strip	/LL /R		
		Leatherette			
	911 555 084 48 8AE	Lobster	-78		
	911 555 084 48 5AE	Cork			
	911 555 084 48 7AE	Black			
(2)	911 555 084 48 21S	Brown	-79	1	SC
	911 555 084 48 30B	Dark blue	80-		
	911 555 084 48 3MX	Burgundy	83-		
	911 555 084 48 4RB	Brown	83-		
	911 555 083 46	Cover strip	/RL /L		
		Leatherette			
	911 555 083 46 8AE	Lobster	-78		
	911 555 083 46 5AE	Cork			
(2)	911 555 083 46 7AE	Black	79-	1	SC
	911 555 083 46 21S	Brown	-82		
	911 555 083 46 30B	Blue	80-		
	911 555 083 46 3MX	Burgundy	83-		
	911 555 083 46 4RB	Brown	83-		
	911 555 084 45	Cover strip	/RL /R		
		Leatherette			
	911 555 084 45 8AE	Lobster	-78		
(2)	911 555 084 45 5AE	Cork		1	SC
	911 555 084 45 7AE	Black	79-		
	911 555 084 45 21S	Brown	-82		
	911 555 084 45 30B	Dark blue	80-		
	911 555 084 45 3MX	Burgundy	83-		
	911 555 084 45 4RB	Brown	83-		
	911 555 083 48	Cover strip	/RL /L		
		Leatherette			
(2)	911 555 083 48 8AE	Lobster	-78	1	SC
	911 555 083 48 5AE	Cork			
	911 555 083 48 7AE	Black	79-		
	911 555 083 48 21S	Brown	-82		
	911 555 083 48 30B	Dark blue	80-		
	911 555 083 48 3MX	Burgundy	83-		
	911 555 083 48 4RB	Brown	83-		
	911 555 084 47	Cover strip	/RL /R		
	Leatherette				
(2)	911 555 084 47 8AE	Lobster	-78	1	SC
	911 555 084 47 5AE	Cork			
	911 555 084 47 7AE	Black	79-		
	911 555 084 47 21S	Brown	-82		
	911 555 084 47 30B	Dark blue	80-		
	911 555 084 47 3MX	Burgundy	83-		
	911 555 084 47 4RB	Brown	83-		
	911 555 083 72	Cover strip	/LL /L		
	Leather				
(2)	911 555 083 72 8AH	Lobster	-78	1	COUPE
	911 555 083 72 5AH	Cork	-79		
	911 555 083 72 7AG	Black	-79		
	911 555 083 72 20B	Dark green			
	911 555 083 72 3NG	Brown	-82		
	911 555 083 72 3AG	Blue	-79		
	911 555 083 72 8AT	Light red	-79		
	911 555 083 72 1AJ	Black	80-82		
	911 555 083 72 30B	Dark blue	80-82		
	911 555 083 72 30A	Blue	80		
	911 555 083 72 40D	Cork	80		
	911 555 083 72 60S	Hannibal grey	81-		
911 555 083 72 20S	Mint green	81-			

Model: 911 78 Model life 1978>>1983

Pos	Part Number	Description	Remark	Qty	Model
	911 555 083 72 6AD	Doric grey	80		
	911 555 083 72 2LB	Burgundy			
	911 555 083 72 LG7	Burgundy	83-		
	911 555 083 72 LG6	Dark green	83-		
	911 555 083 72 KZ2	Black	83-		
	911 555 083 72 KZ3	Blue	83-		
	911 555 083 72 KZ5	Brown	83-		
(2)	911 555 084 73	Cover strip Leather	/LL /R	1	COUPE
	911 555 084 73 8AH	Lobster	-78		
	911 555 084 73 5AH	Cork	-79		
	911 555 084 73 7AG	Black	-79		
	911 555 084 73 20B	Dark green			
	911 555 084 73 3NG	Brown	-82		
	911 555 084 73 3AG	Blue	-79		
	911 555 084 73 8AT	Light red	-79		
	911 555 084 73 1AJ	Black	80-82		
	911 555 084 73 30B	Dark blue	80-82		
	911 555 084 73 30A	Blue	80		
	911 555 084 73 40D	Cork	80		
	911 555 084 73 60S	Hannibal grey	81-		
	911 555 084 73 20S	Mint green	81-		
	911 555 084 73 6AD	Doric grey	80		
	911 555 084 73 2LB	Burgundy			
	911 555 084 73 LG7	Burgundy	83-		
	911 555 084 73 LG6	Dark green	83-		
	911 555 084 73 KZ2	Black	83-		
	911 555 084 73 KZ3	Blue	83-		
	911 555 084 73 KZ5	Brown	83-		
(2)	911 555 083 79	Cover strip Leather	/LL /L	1	
	911 555 083 79 8AH	Lobster	-78		
	911 555 083 79 5AH	Cork	-79		
	911 555 083 79 7AG	Black	-79		
	911 555 083 79 20B	Dark green			
	911 555 083 79 3NG	Brown	-82		
	911 555 083 79 3AG	Blue	-79		
	911 555 083 79 8AT	Light red	-79		
	911 555 083 79 1AJ	Black	80-82		
	911 555 083 79 30B	Dark blue	80-82		
	911 555 083 79 30A	Blue	80		
	911 555 083 79 40D	Cork	80		
	911 555 083 79 60S	Hannibal grey	81-		
	911 555 083 79 20S	Mint green	81-		
	911 555 083 79 6AD	Doric grey	80		
	911 555 083 79 2LB	Burgundy			
	911 555 083 79 LG7	Burgundy	83-		
	911 555 083 79 LG6	Dark green	83-		
	911 555 083 79 KZ2	Black	83-		
	911 555 083 79 KZ3	Blue	83-		
	911 555 083 79 KZ5	Brown	83-		
(2)	911 555 084 80	Cover strip Leather	/LL /R	1	
	911 555 084 80 8AH	Lobster	-78		
	911 555 084 80 5AH	Cork	-79		
	911 555 084 80 7AG	Black	-79		
	911 555 084 80 20B	Dark green			
	911 555 084 80 3NG	Brown	-82		
	911 555 084 80 3AG	Blue	-79		
	911 555 084 80 8AT	Light red	-79		
	911 555 084 80 1AJ	Black	80-82		
	911 555 084 80 30B	Dark blue	80-82		
	911 555 084 80 30A	Blue	80		

Model: 911 78 Model life 1978>>1983

Pos	Part Number	Description	Remark	Qty	Model
	911 555 084 80 40D	Cork	80		
	911 555 084 80 60S	Hannibal grey	81-		
	911 555 084 80 20S	Mint green	81-		
	911 555 084 80 6AD	Doric grey	80		
	911 555 084 80 2LB	Burgundy			
	911 555 084 80 LG7	Burgundy	83-		
	911 555 084 80 LG6	Dark green	83-		
	911 555 084 80 KZ2	Black	83-		
	911 555 084 80 KZ3	Blue	83-		
	911 555 084 80 KZ5	Brown	83-		
(2)	911 555 083 80	Cover strip Leather	/RL /L	1	
	911 555 083 80 8AH	Lobster	-78		
	911 555 083 80 5AH	Cork	-79		
	911 555 083 80 7AG	Black	-79		
	911 555 083 80 20B	Dark green			
	911 555 083 80 3NG	Brown	-82		
	911 555 083 80 3AG	Blue	-79		
	911 555 083 80 8AT	Light red	-79		
	911 555 083 80 1AJ	Black	80-82		
	911 555 083 80 30B	Dark blue	80-82		
	911 555 083 80 30A	Blue	80		
	911 555 083 80 40D	Cork	80		
	911 555 083 80 60S	Hannibal grey	81-		
	911 555 083 80 20S	Mint green	81-		
	911 555 083 80 6AD	Doric grey	80		
	911 555 083 80 2LB	Burgundy			
	911 555 083 80 LG7	Burgundy	83-		
	911 555 083 80 LG6	Dark green	83-		
	911 555 083 80 KZ2	Black	83-		
	911 555 083 80 KZ3	Blue	83-		
	911 555 083 80 KZ5	Brown	83-		
(2)	911 555 084 79	Cover strip Leather	/RL /R	1	
	911 555 084 79 8AH	Lobster	-78		
	911 555 084 79 5AH	Cork	-79		
	911 555 084 79 7AG	Black	-79		
	911 555 084 79 20B	Dark green			
	911 555 084 79 3NG	Brown	-82		
	911 555 084 79 3AG	Blue	-79		
	911 555 084 79 8AT	Light red	-79		
	911 555 084 79 1AJ	Black	80-82		
	911 555 084 79 30B	Dark blue	80-82		
	911 555 084 79 30A	Blue	80		
	911 555 084 79 40D	Cork	80		
	911 555 084 79 60S	Hannibal grey	81-		
	911 555 084 79 20S	Mint green	81-		
	911 555 084 79 6AD	Doric grey	80		
	911 555 084 79 2LB	Burgundy			
	911 555 084 79 LG7	Burgundy	83-		
	911 555 084 79 LG6	Dark green	83-		
	911 555 084 79 KZ2	Black	83-		
	911 555 084 79 KZ3	Blue	83-		
	911 555 084 79 KZ5	Brown	83-		
(2)	911 555 083 77	Cover strip Leather	/LL /L	1	TARGA/CABRIO
	911 555 083 77 8AH	Lobster	-78		
	911 555 083 77 5AH	Cork	-79		
	911 555 083 77 7AG	Black	-79		
	911 555 083 77 20B	Dark green	-82		
	911 555 083 77 3NG	Brown	-82		
	911 555 083 77 3AG	Blue	-79		
	911 555 083 77 8AT	Light red	-79		

Model: 911 78 Model life 1978>>1983

Pos	Part Number	Description	Remark	Qty	Model
	911 555 083 77 1AJ	Black	80-82		
	911 555 083 77 30B	Dark blue	80-82		
	911 555 083 77 30A	Blue	80		
	911 555 083 77 40D	Cork	80		
	911 555 083 77 60S	Hannibal grey	81-82		
	911 555 083 77 20S	Mint green	81-82		
	911 555 083 77 2LB	Burgundy			
	911 555 083 77 LG7	Burgundy	83-		
	911 555 083 77 LG6	Dark green	83-		
	911 555 083 77 KZ2	Black	83-		
	911 555 083 77 KZ3	Blue	83-		
	911 555 083 77 KZ5	Brown	83-		
(2)	911 555 084 78	Cover strip Leather	/LL /R	1	TARGA/CABRIO
	911 555 084 78 8AH	Lobster	-78		
	911 555 084 78 5AH	Cork	-79		
	911 555 084 78 7AG	Black	-79		
	911 555 084 78 20B	Dark green	-82		
	911 555 084 78 3NG	Brown	-82		
	911 555 084 78 3AG	Blue	-79		
	911 555 084 78 8AT	Light red	-79		
	911 555 084 78 1AJ	Black	80-82		
	911 555 084 78 30B	Dark blue	80-82		
	911 555 084 78 30A	Blue	80		
	911 555 084 78 40D	Cork	80		
	911 555 084 78 60S	Hannibal grey	81-82		
	911 555 084 78 20S	Mint green	81-82		
	911 555 084 78 2LB	Burgundy			
	911 555 084 78 LG7	Burgundy	83-		
	911 555 084 78 LG6	Dark green	83-		
	911 555 084 78 KZ2	Black	83-		
	911 555 084 78 KZ3	Blue	83-		
	911 555 084 78 KZ5	Brown	83-		
(2)	911 555 083 79	Cover strip Leather	/LL /L	1	
	911 555 083 79 8AH	Lobster	-78		
	911 555 083 79 5AH	Cork	-79		
	911 555 083 79 7AG	Black	-79		
	911 555 083 79 20B	Dark green	-82		
	911 555 083 79 3NG	Brown	-82		
	911 555 083 79 3AG	Blue	-79		
	911 555 083 79 8AT	Light red	-79		
	911 555 083 79 1AJ	Black	80-82		
	911 555 083 79 30B	Dark blue	80-82		
	911 555 083 79 30A	Blue	80		
	911 555 083 79 40D	Cork	80		
	911 555 083 79 60S	Hannibal grey	81-82		
	911 555 083 79 20S	Mint green	81-82		
	911 555 083 79 2LB	Burgundy			
	911 555 083 79 LG7	Burgundy	83-		
	911 555 083 79 LG6	Dark green	83-		
	911 555 083 79 KZ2	Black	83-		
	911 555 083 79 KZ3	Blue	83-		
	911 555 083 79 KZ5	Brown	83-		
2	911 555 084 80	Cover strip Leather	/LL /R	1	
	911 555 084 80 8AH	Lobster	-78		
	911 555 084 80 5AH	Cork	-79		
	911 555 084 80 7AG	Black	-79		
	911 555 084 80 20B	Dark green	-82		
	911 555 084 80 3NG	Brown	-82		
	911 555 084 80 3AG	Blue	-79		
	911 555 084 80 8AT	Light red	-79		

Model: 911 78 Model life 1978>>1983

Pos	Part Number	Description	Remark	Qty	Model
	911 555 084 80 1AJ	Black	80-82		
	911 555 084 80 30B	Dark blue	80-82		
	911 555 084 80 30A	Blue	80		
	911 555 084 80 40D	Cork	80		
	911 555 084 80 60S	Hannibal grey	81-82		
	911 555 084 80 20S	Mint green	81-82		
	911 555 084 80 2LB	Burgundy			
	911 555 084 80 LG7	Burgundy	83-		
	911 555 084 80 LG6	Dark green	83-		
	911 555 084 80 KZ2	Black	83-		
	911 555 084 80 KZ3	Blue	83-		
	911 555 084 80 KZ5	Brown	83-		
(2)	911 555 083 78	Cover strip Leather	/RL /L	1	TARGA/CABRIO
	911 555 083 78 8AH	Lobster	-78		
	911 555 083 78 5AH	Cork	-79		
	911 555 083 78 7AG	Black	-79		
	911 555 083 78 20B	Dark green	-82		
	911 555 083 78 3NG	Brown	-82		
	911 555 083 78 3AG	Blue	-79		
	911 555 083 78 8AT	Light red	-79		
	911 555 083 78 1AJ	Black	80-82		
	911 555 083 78 30B	Dark blue	80-82		
	911 555 083 78 30A	Blue	80		
	911 555 083 78 40D	Cork	80		
	911 555 083 78 60S	Hannibal grey	81-82		
	911 555 083 78 20S	Mint green	81-82		
	911 555 083 78 2LB	Burgundy			
	911 555 083 78 LG7	Burgundy	83-		
	911 555 083 78 LG6	Dark green	83-		
	911 555 083 78 KZ2	Black	83-		
	911 555 083 78 KZ3	Blue	83-		
	911 555 083 78 KZ5	Brown	83-		
2	911 555 084 77	Cover strip Leather	/RL /R	1	TARGA/CABRIO
	911 555 084 77 8AH	Lobster	-78		
	911 555 084 77 5AH	Cork	-79		
	911 555 084 77 7AG	Black	-79		
	911 555 084 77 20B	Dark green	-82		
	911 555 084 77 3NG	Brown	-82		
	911 555 084 77 3AG	Blue	-79		
	911 555 084 77 8AT	Light red	-79		
	911 555 084 77 1AJ	Black	80-82		
	911 555 084 77 30B	Dark blue	80-82		
	911 555 084 77 30A	Blue	80		
	911 555 084 77 40D	Cork	80		
	911 555 084 77 60S	Hannibal grey	81-82		
	911 555 084 77 20S	Mint green	81-82		
	911 555 084 77 2LB	Burgundy			
	911 555 084 77 LG7	Burgundy	83-		
	911 555 084 77 LG6	Dark green	83-		
	911 555 084 77 KZ2	Black	83-		
	911 555 084 77 KZ3	Blue	83-		
	911 555 084 77 KZ5	Brown	83-		
(2)	911 555 083 80	Cover strip Leather	/RL /L	1	
	911 555 083 80 8AH	Lobster	-78		
	911 555 083 80 5AH	Cork	-79		
	911 555 083 80 7AG	Black	-79		
	911 555 083 80 20B	Dark green	-82		
	911 555 083 80 3NG	Brown	-82		
	911 555 083 80 3AG	Blue	-79		
	911 555 083 80 8AT	Light red	-79		

Model: 911 78 Model life 1978>>1983

Pos	Part Number	Description	Remark	Qty	Model
	911 555 083 80 1AJ	Black	80-82		
	911 555 083 80 30B	Dark blue	80-82		
	911 555 083 80 30A	Blue	80		
	911 555 083 80 40D	Cork	80		
	911 555 083 80 60S	Hannibal grey	81-82		
	911 555 083 80 20S	Mint green	81-82		
	911 555 083 80 2LB	Burgundy			
	911 555 083 80 LG7	Burgundy	83-		
	911 555 083 80 LG6	Dark green	83-		
	911 555 083 80 KZ2	Black	83-		
	911 555 083 80 KZ3	Blue	83-		
	911 555 083 80 KZ5	Brown	83-		
(2)	911 555 084 79	Cover strip Leather	/RL /R	1	
	911 555 084 79 8AH	Lobster	-78		
	911 555 084 79 5AH	Cork	-79		
	911 555 084 79 7AG	Black	-79		
	911 555 084 79 20B	Dark green	-82		
	911 555 084 79 3NG	Brown	-82		
	911 555 084 79 3AG	Blue	-79		
	911 555 084 79 8AT	Light red	-79		
	911 555 084 79 1AJ	Black	80-82		
	911 555 084 79 30B	Dark blue	80-82		
	911 555 084 79 30A	Blue	80		
	911 555 084 79 40D	Cork	80		
	911 555 084 79 60S	Hannibal grey	81-82		
	911 555 084 79 20S	Mint green	81-82		
	911 555 084 79 2LB	Burgundy			
	911 555 084 79 LG7	Burgundy	83-		
	911 555 084 79 LG6	Dark green	83-		
	911 555 084 79 KZ2	Black	83-		
	911 555 084 79 KZ3	Blue	83-		
	911 555 084 79 KZ5	Brown	83-		
3	900 145 071 07	Tapping screw B 3,5 X 13		2	
4	999 591 116 07	Cone washer		2	
5	N 013 958 7	Oval-head sheetmetal screw B 3,5 X 13		2	
6	914 552 233 10	Filler piece		2	
	914 552 233 10 01C	Black			
6	914 552 233 10	Filler piece		2	
	914 552 233 10 01C	Black			
7	999 591 311 40	Bush		6	
8	823 867 299	Clip		6	
(9)	911 555 037 02	Package box Velour pile Wrapping strap Leatherette	/L -78	1	SC
	911 555 037 02 8BC	Lobster	-78		
	911 555 037 02 5BB	Cork			
	911 555 037 02 7BB	Black			
9	911 555 038 02	Package box Velour pile Wrapping strap Leatherette	/R -78	1	SC
	911 555 038 02 8BC	Lobster	-78		
	911 555 038 02 5BB	Cork			
	911 555 038 02 7BB	Black			
(9)	911 555 037 04	Package box Velour pile Wrapping strap Leatherette	/L -78	1	SC
	911 555 037 04 8BC	Lobster	-78		

Model: 911 78 Model life 1978>>1983

Pos	Part Number	Description	Remark	Qty	Model
(9)	911 555 037 04 5BB	Cork		1	SC
	911 555 037 04 7BB	Black			
	911 555 038 04	Package box Velour pile Wrapping strap Leatherette	/R -78		
	911 555 038 04 8BC	Lobster	-78		
(9)	911 555 038 04 5BB	Cork		1	SC
	911 555 038 04 7BB	Black			
	911 555 037 02	Package box Cut pile Wrapping strap Leatherette	/L 79		
	911 555 037 02 4AC	Brown			
9	911 555 037 02 5AC	Cork		1	SC
	911 555 037 02 7AC	Black			
	911 555 038 02	Package box Cut pile Wrapping strap Leatherette	/R 79		
	911 555 038 02 4AC	Brown			
(9)	911 555 038 02 5AC	Cork		1	SC
	911 555 038 02 7AC	Black			
	911 555 037 04	Package box Cut pile Wrapping strap Leatherette	/L 79		
	911 555 037 04 4AC	Brown			
(9)	911 555 037 04 5AC	Cork		1	SC
	911 555 037 04 7AC	Black			
	911 555 038 04	Package box Cut pile Wrapping strap Leatherette	/R 79		
	911 555 038 04 4AC	Brown			
(9)	911 555 038 04 5AC	Cork		1	SC
	911 555 038 04 7AC	Black			
	911 555 037 02	Package box Cut pile Wrapping strap Leatherette	/L 80-		
	911 555 037 02 70E	Black/black			
9	911 555 037 02 40E	Brown/brown		1	SC
	911 555 037 02 30B	Blue/blue			
	911 555 037 02 50B	Beige			
	911 555 037 02 80E	Burgundy/burgundy	83-		
	911 555 037 02 2FL	Grey-beige/grey-beige	83-		
	911 555 037 02 60A	Light grey/black	83-		
	911 555 038 02	Package box Cut pile Wrapping strap Leatherette	/R 80-		
	911 555 038 02 70E	Black/black			
	911 555 038 02 40E	Brown/brown			
	911 555 038 02 30B	Blue/blue			
(9)	911 555 038 02 50B	Beige		1	SC
	911 555 038 02 80E	Burgundy/burgundy	83-		
	911 555 038 02 2FL	Grey-beige/grey-beige	83-		
	911 555 038 02 60A	Light grey/black	83-		
	911 555 037 04	Package box Cut pile Wrapping strap Leatherette	/L 80-		

Model: 911 78 Model life 1978>>1983

Pos	Part Number	Description	Remark	Qty	Model
	911 555 037 04 70E	Black/black			
	911 555 037 04 40E	Brown/brown			
	911 555 037 04 30B	Blue/blue			
	911 555 037 04 50B	Beige			
	911 555 037 04 80E	Burgundy/burgundy	83-		
	911 555 037 04 2FL	Grey-beige/grey-beige	83-		
	911 555 037 04 60A	Light grey/black	83-		
(9)	911 555 038 04	Package box	/R	1	SC
		Cut pile	80-		
		Wrapping strap			
		Leatherette			
	911 555 038 04 70E	Black/black			
	911 555 038 04 40E	Brown/brown			
	911 555 038 04 30B	Blue/blue			
	911 555 038 04 50B	Beige			
	911 555 038 04 80E	Burgundy/burgundy	83-		
	911 555 038 04 2FL	Grey-beige/grey-beige	83-		
	911 555 038 04 60A	Light grey/black	83-		
-	911 555 029 01	Cover	/L	1	
		Package box			
		Velour pile	-78		
	911 555 029 01 8BC	Lobster			
	911 555 029 01 5BB	Cork			
	911 555 029 01 7BB	Black			
-	911 555 030 01	Cover	/R	1	
		Package box			
		Velour pile	-78		
	911 555 030 01 8BC	Lobster			
	911 555 030 01 5BB	Cork			
	911 555 030 01 7BB	Black			
-	911 555 029 01	Cover	/L	1	
		Cut pile	79		
	911 555 029 01 4AC	Brown			
	911 555 029 01 5AC	Cork			
	911 555 029 01 7AC	Black			
-	911 555 030 01	Cover	/R	1	
		Cut pile	79		
	911 555 030 01 4AC	Brown			
	911 555 030 01 5AC	Cork			
	911 555 030 01 7AC	Black			
-	911 555 029 01	Cover	/L	1	
		Cut pile	80-		
	911 555 029 01 70E	Black			
	911 555 029 01 40E	Brown			
	911 555 029 01 30B	Dark blue			
	911 555 029 01 50B	Beige			
	911 555 029 01 80E	Burgundy	83-		
	911 555 029 01 2FL	Grey-beige	83-		
	911 555 029 01 60A	Light grey	83-		
-	911 555 030 01	Cover	/R	1	
		Cut pile	80-		
	911 555 030 01 70E	Black			
	911 555 030 01 40E	Brown			
	911 555 030 01 30B	Dark blue			
	911 555 030 01 50B	Beige			
	911 555 030 01 80E	Burgundy	83-		
	911 555 030 01 2FL	Grey-beige	83-		
	911 555 030 01 60A	Light grey	83-		
(9)	930 555 037 01	Package box	/L	1	
		Velour pile	-78		
		Wrapping strap			
		Leather			
	930 555 037 01 8BC	Lobster			

Model: 911 78 Model life 1978>>1983

Pos	Part Number	Description	Remark	Qty	Model
	930 555 037 01 5BB	Cork			
	930 555 037 01 7BB	Black			
	930 555 037 01 20B	Dark green			
	930 555 037 01 40A	Brown			
	930 555 037 01 8BB	Light red			
	930 555 037 01 1BA	Yellow			
9	930 555 038 01	Package box Velour pile Wrapping strap Leather	/R -78	1	
	930 555 038 01 8BC	Lobster			
	930 555 038 01 5BB	Cork			
	930 555 038 01 7BB	Black			
	930 555 038 01 20B	Dark green			
	930 555 038 01 40A	Brown			
	930 555 038 01 8BB	Light red			
	930 555 038 01 1BA	Yellow			
(9)	930 555 037 03	Package box Velour pile Wrapping strap Leather	/L -78	1	
	930 555 037 03 8BC	Lobster			
	930 555 037 03 5BB	Cork			
	930 555 037 03 7BB	Black			
	930 555 037 03 20B	Dark green			
	930 555 037 03 40A	Brown			
	930 555 037 03 8BB	Light red			
	930 555 037 03 1BA	Yellow			
(9)	930 555 038 03	Package box Velour pile Wrapping strap Leather	/R -78	1	
	930 555 038 03 8BC	Lobster			
	930 555 038 03 5BB	Cork			
	930 555 038 03 7BB	Black			
	930 555 038 03 20B	Dark green			
	930 555 038 03 40A	Brown			
	930 555 038 03 8BB	Light red			
	930 555 038 03 1BA	Yellow			
(9)	930 555 037 01	Package box Cut pile Wrapping strap Leather	/L 79	1	
	930 555 037 01 5AC	Cork			
	930 555 037 01 7AC	Black			
	930 555 037 01 2AC	Dark green			
	930 555 037 01 4AC	Brown			
	930 555 037 01 8AC	Light red			
	930 555 037 01 1AC	Yellow			
9	930 555 038 01	Package box Cut pile Wrapping strap Leather	/R 79	1	
	930 555 038 01 5AC	Cork			
	930 555 038 01 7AC	Black			
	930 555 038 01 2AC	Dark green			
	930 555 038 01 4AC	Brown			
	930 555 038 01 8AC	Light red			
	930 555 038 01 1AC	Yellow			
(9)	930 555 037 03	Package box Cut pile Wrapping strap Leather	/L 79	1	

Model: 911 78 Model life 1978>>1983

Pos	Part Number	Description	Remark	Qty	Model
	930 555 037 03 5AC	Cork			
	930 555 037 03 7AC	Black			
	930 555 037 03 2AC	Dark green			
	930 555 037 03 4AC	Brown			
	930 555 037 03 8AC	Light red			
	930 555 037 03 1AC	Yellow			
(9)	930 555 038 03	Package box Cut pile Wrapping strap Leather	/R 79	1	
	930 555 038 03 5AC	Cork			
	930 555 038 03 7AC	Black			
	930 555 038 03 2AC	Dark green			
	930 555 038 03 4AC	Brown			
	930 555 038 03 8AC	Light red			
	930 555 038 03 1AC	Yellow			
(9)	930 555 037 01	Package box Cut pile Wrapping strap Leather	/L	1	
	930 555 037 01 70E	Black/black	80-		
	930 555 037 01 40E	Brown/brown	80-		
	930 555 037 01 30B	Blue/blue	80-		
	930 555 037 01 50B	Beige	80-		
	930 555 037 01 20E	Dark green	80		
	930 555 037 01 41D	Cork	80		
	930 555 037 01 10A	Yellow	80		
	930 555 037 01 80B	Red	80		
	930 555 037 01 20S	Mint green	81-		
	930 555 037 01 8AY	Russet	80		
	930 555 037 01 80E	Burgundy/burgundy			
	930 555 037 01 2FL	Grey-beige/grey-beige	83-		
	930 555 037 01 60A	Light grey/black	83-		
	930 555 037 01 1VD	Champagne/champagne	83-		
	930 555 037 01 6JD	Dark green/dark green	83-		
9	930 555 037 01 80S	Can-can-red/can-can-red			
	930 555 038 01	Package box Cut pile Wrapping strap Leather	/R	1	
	930 555 038 01 70E	Black/black	80-		
	930 555 038 01 40E	Brown/brown	80-		
	930 555 038 01 30B	Blue/blue	80-		
	930 555 038 01 50B	Beige	80-		
	930 555 038 01 20E	Dark green	80		
	930 555 038 01 41D	Cork	80		
	930 555 038 01 10A	Yellow	80		
	930 555 038 01 80B	Red	80		
	930 555 038 01 20S	Mint green	81-		
	930 555 038 01 8AY	Russet	80		
	930 555 038 01 80E	Burgundy/burgundy			
	930 555 038 01 2FL	Grey-beige/grey-beige	83-		
	930 555 038 01 60A	Light grey/black	83-		
	930 555 038 01 1VD	Champagne/champagne	83-		
	930 555 038 01 6JD	Dark green/dark green	83-		
9	930 555 038 01 80S	Can-can-red/can-can-red			
(9)	930 555 037 03	Package box Cut pile Wrapping strap Leather	/L	1	
	930 555 037 03 70E	Black/black	80-		
	930 555 037 03 40E	Brown/brown	80-		
	930 555 037 03 30B	Blue/blue	80-		

Model: 911 78 Model life 1978>>1983

Pos	Part Number	Description	Remark	Qty	Model
	930 555 037 03 50B	Beige	80-		
	930 555 037 03 20E	Dark green	80		
	930 555 037 03 41D	Cork	80		
	930 555 037 03 10A	Yellow	80		
	930 555 037 03 80B	Red	80		
	930 555 037 03 20S	Mint green	81-		
	930 555 037 03 8AY	Russet	80		
	930 555 037 03 80E	Burgundy/burgundy			
	930 555 037 03 2FL	Grey-beige/grey-beige	83-		
	930 555 037 03 60A	Light grey/black	83-		
	930 555 037 03 1VD	Champagne/champagne	83-		
	930 555 037 03 6JD	Dark green/dark green	83-		
(9)	930 555 037 03 80S	Can-can-red/can-can-red			
	930 555 038 03	Package box	/R	1	
		Cut pile			
		Wrapping strap			
		Leather			
	930 555 038 03 70E	Black/black	80-		
	930 555 038 03 40E	Brown/brown	80-		
	930 555 038 03 30B	Blue/blue	80-		
	930 555 038 03 50B	Beige	80-		
	930 555 038 03 20E	Dark green	80		
	930 555 038 03 41D	Cork	80		
	930 555 038 03 10A	Yellow	80		
	930 555 038 03 80B	Red	80		
	930 555 038 03 20S	Mint green	81-		
	930 555 038 03 8AY	Russet	80		
	930 555 038 03 80E	Burgundy/burgundy			
	930 555 038 03 2FL	Grey-beige/grey-beige	83-		
	930 555 038 03 60A	Light grey/black	83-		
	930 555 038 03 1VD	Champagne/champagne	83-		
	930 555 038 03 6JD	Dark green/dark green	83-		
	930 555 038 03 80S	Can-can-red/can-can-red			
-	930 555 039 00	Cover	/L	1	
		Velour pile			
		Wrapping strap			
		Leather	-78		
	930 555 039 00 8BC	Lobster			
	930 555 039 00 5BB	Cork			
	930 555 039 00 7BB	Black			
	930 555 039 00 20B	Dark green			
	930 555 039 00 40A	Brown			
	930 555 039 00 8BB	Light red			
	930 555 039 00 1BA	Yellow			
-	930 555 040 00	Cover	/R	1	
		Velour pile			
		Wrapping strap			
		Leather	-78		
	930 555 040 00 8BC	Lobster			
	930 555 040 00 5BB	Cork			
	930 555 040 00 7BB	Black			
	930 555 040 00 20B	Dark green			
	930 555 040 00 40A	Brown			
	930 555 040 00 8BB	Light red			
	930 555 040 00 1BA	Yellow			
-	930 555 039 00	Cover	/L	1	
		Cut pile	79		
		Wrapping strap			
		Leather			
	930 555 039 00 5AC	Cork			
	930 555 039 00 7AC	Black			
	930 555 039 00 2AC	Dark green			
	930 555 039 00 4AC	Brown			

Model: 911 78

Model life 1978>>1983

Pos	Part Number	Description	Remark	Qty	Model
-	930 555 039 00 8AC	Light red			
	930 555 039 00 1AC	Yellow			
	930 555 040 00	Cover	/R	1	
		Cut pile	79		
		Wrapping strap			
		Leather			
	930 555 040 00 5AC	Cork			
	930 555 040 00 7AC	Black			
	930 555 040 00 2AC	Dark green			
	930 555 040 00 4AC	Brown			
	930 555 040 00 8AC	Light red			
	930 555 040 00 1AC	Yellow			
-	930 555 039 00	Cover	/L	1	
		Cut pile			
		Wrapping strap			
		Leather			
	930 555 039 00 70E	Black	80-		
	930 555 039 00 40E	Brown	80-		
	930 555 039 00 30B	Dark blue	80-		
	930 555 039 00 50B	Beige	80-		
	930 555 039 00 20E	Dark green	80		
	930 555 039 00 41D	Cork	80		
	930 555 039 00 10A	Yellow	80		
	930 555 039 00 80B	Red	80		
	930 555 039 00 20S	Mint green	81-		
	930 555 039 00 8AY	Russet	80		
	930 555 039 00 80E	Burgundy			
	930 555 039 00 2FL	Grey-beige	83-		
	930 555 039 00 60A	Light grey	83-		
	930 555 039 00 1VD	Champagne	83-		
	930 555 039 00 6JD	Dark green	83-		
	930 555 039 00 80S	Can-can-red			
-	930 555 040 00	Cover	/R	1	
		Cut pile			
		Wrapping strap			
		Leather			
	930 555 040 00 70E	Black	80-		
	930 555 040 00 40E	Brown	80-		
	930 555 040 00 30B	Dark blue	80-		
	930 555 040 00 50B	Beige	80-		
	930 555 040 00 20E	Dark green	80		
	930 555 040 00 41D	Cork	80		
	930 555 040 00 10A	Yellow	80		
	930 555 040 00 80B	Red	80		
	930 555 040 00 20S	Mint green	81-		
	930 555 040 00 8AY	Russet	80		
	930 555 040 00 80E	Burgundy			
	930 555 040 00 2FL	Grey-beige	83-		
	930 555 040 00 60A	Light grey	83-		
	930 555 040 00 1VD	Champagne	83-		
	930 555 040 00 6JD	Dark green	83-		
	930 555 040 00 80S	Can-can-red			
10	911 555 391 00	Mounting		2	
11	900 143 046 07	Tapping screw		2	
		B 4,8 X 16			
12	900 145 079 07	Oval-head sheetmetal screw		2	
		B 4,8 X 19			
13	999 704 605 07	Cone washer		2	
14	900 269 058 07	Countersunk-head screw		6	
		M 4 X 25			
15	999 591 103 17	Protection washer		6	
15	PCG 591 103 17	Protection washer		6	
(16)	911 555 097 01	Grab handle	/L	1	

Model: 911 78 Model life 1978>>1983

Pos	Part Number	Description	Remark	Qty	Model
(16)	911 555 097 01 041	Black			
	911 555 098 01	Grab handle	/R	1	
	911 555 098 01 041	Black			
17	N 014 761 2	Pan-head screw M 6 X 12		4	
17	900 119 129 01	Pan-head screw M 6 X 12		4	
18	N 012 226 5	Spring washer B 6		4	
(19)	911 531 251 00	Door opener	/L	1	
	911 531 251 00 70B	Black			
(19)	911 531 252 00	Door opener	/R	1	
	911 531 252 00 70B	Black			
19A	911 555 583 00	Bolt		2	
19A	911 555 583 01	Bolt		2	
19B	900 116 002 01	Lock washer		2	
20	900 145 075 07	Tapping screw B 4,2 X 16		2	
21	999 591 102 17	Washer	-78	2	
21	999 591 102 1H	Washer		2	
(22)	911 555 039 03	Lid	/L	1	
	911 555 039 03 041	Black Lacquered			
22	911 555 040 03	Lid	/R	1	
	911 555 040 03 041	Black Lacquered			
23	914 555 059 10	Support		2	
24	900 146 011 02	Oval-head screw AM 4 X 10		2	
25	N 012 224 3	Spring washer B 4		2	
26	900 151 028 02	Washer B 4,3		2	
26	900 151 028 01	Washer B 4,3		2	
(27)	911 555 045 03	Bearing	/L	1	
27	911 555 046 03	Bearing	/R	1	
28	900 143 046 07	Tapping screw B 4,8 X 16		4	
29	900 145 079 07	Oval-head sheetmetal screw B 4,8 X 19		2	
30	999 704 605 07	Cone washer		2	
31	911 613 623 01	Grommet		3	
32	911 613 621 03	Switch		3	
33	911 613 635 20	Assembly frame		3	
34	911 613 637 00	Seal	/L -80	3	
35	911 613 638 00	Seal	/R -80	1	

Model: 911 78

Model life 1978>>1983

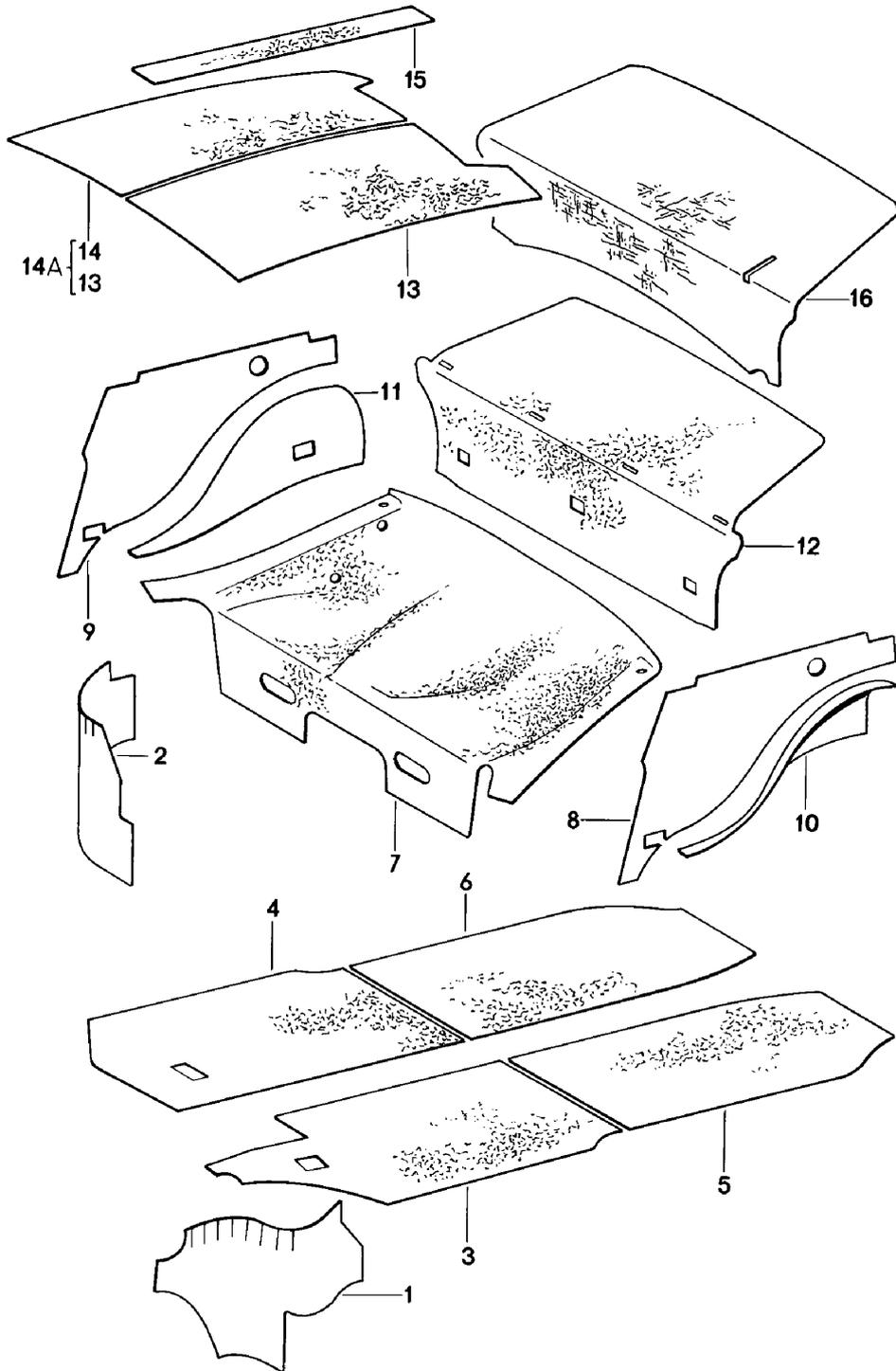

Model: 911 78 Model life 1978>>1983

Pos	Part Number	Description	Remark	Qty	Model
		Body			
		Sound proofing 1			
(1)	911 556 902 00	Damping mat	/L	1	TARGA/CABRIO
1		Damping mat	/L	1	COUPE
(2)		Damping mat	/R	1	COUPE
2		Damping mat	/R	1	TARGA/CABRIO
		Wheel housing			
3		Damping mat	/LL /L	1	COUPE
(3)		Damping mat	/LL /L	1	TARGA/CABRIO
(3)		Damping mat	/RL /L	1	
		Floor			
4		Damping mat	/LL /R	1	COUPE
(4)		Damping mat	/LL /R	1	TARGA/CABRIO
(4)		Damping mat	/RL /R	1	
		Floor			
5		Damping mat	/L	1	
		Floor			
6		Damping mat	/R	1	
		Floor			
(7)	930 556 233 02	Damping mat		1	
		Seat well			
8	999 913 006 00	Sound absorber	/L	*	COUPE
(8)		Sound absorber	/L	*	TARGA/CABRIO
		Wheel housing panel			
		Upper			
9		Sound absorber	/R	*	COUPE
(9)		Sound absorber	/R	*	TARGA/CABRIO
		Wheel housing panel			
		Upper			
10		Sound absorber	/L	*	COUPE
(10)		Sound absorber	/L	*	TARGA/CABRIO
		Wheel housing panel			
		Lower			
11		Sound absorber	/R	*	COUPE
(11)		Sound absorber	/R	*	TARGA/CABRIO
		Wheel housing panel			
		Lower			
12	911 556 239 06	Damping mat		1	COUPE/TARGA
(12)	911 556 239 61	Damping mat		1	CABRIO
		for rear panel			
14A	911 556 023 01	Damping mat		1	COUPE
14A	911 556 023 02	Damping mat		1	COUPE
		100 X 90			
		It is necessary to rework			
15	911 556 248 00	Damping strip		4	COUPE
16	911 556 891 01	Damping mat		1	SC
(16)	930 556 891 02	Damping mat		1	TURBO
		for engine compartment			
-	999 913 006 00	Sound absorber		*	

Model: 911 78

Model life 1978>>1983

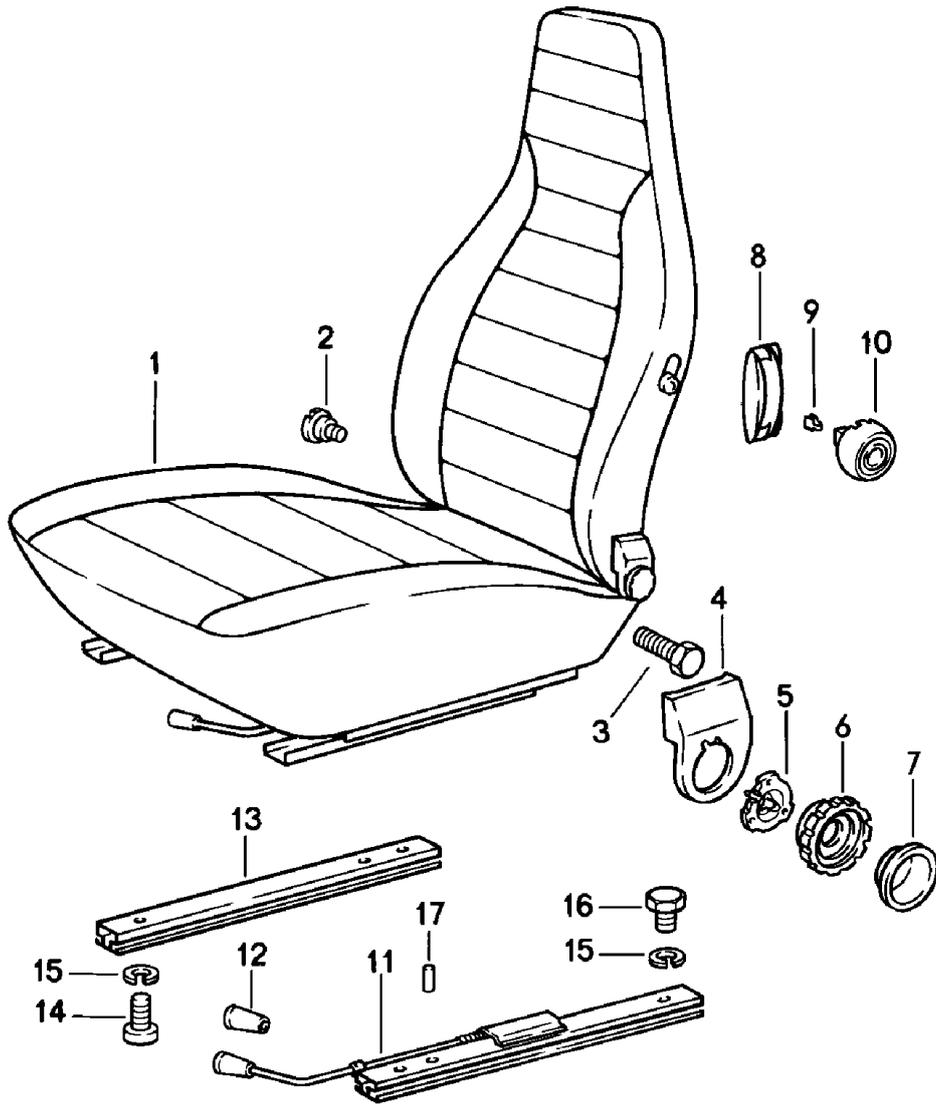

Model: 911 78 Model life 1978>>1983

Pos	Part Number	Description	Remark	Qty	Model
1	911 521 001 81	Front seat Complete	/L -80	1	SC
		Front seat Leatherette/ Centre part Braided texture			
	911 521 001 81 8AT	Lobster	-78		SC
	911 521 001 81 5AT	Cork			SC
	911 521 001 81 7AT	Black			
	911 521 001 81 4AT	Brown	79-		
(1)	911 521 002 81	Front seat	/R -80	1	SC
		Leatherette/ Centre part Braided texture			
	911 521 002 81 8AT	Lobster	-78		SC
	911 521 002 81 5AT	Cork			SC
	911 521 002 81 7AT	Black			
	911 521 002 81 4AT	Brown	79-		
1	911 521 001 82	Front seat	/L	1	SC
		Leatherette/ Centre part Pin stripe velour			
	911 521 001 82 8AK	Lobster/lobster	-78		
	911 521 001 82 5AK	Cork/cork			
	911 521 001 82 7AK	Black/black			
	911 521 001 82 8ZT	Black/lobster			
	911 521 001 82 5ZT	Black/cork			
	911 521 001 82 5ZQ	Brown/cork	79-		
(1)	911 521 002 82	Front seat	/R	1	SC
		Leatherette/ Centre part Pin stripe velour			
	911 521 002 82 8AK	Lobster/lobster	-78		
	911 521 002 82 5AK	Cork/cork			
	911 521 002 82 7AK	Black/black			
	911 521 002 82 8ZT	Black/lobster			
	911 521 002 82 5ZT	Black/cork			
	911 521 002 82 5ZQ	Brown/cork	79-		
1	911 521 001 82	Front seat	/L	1	SC
		Leatherette/ Centre part Tartan cloth			
	911 521 001 82 8ZU	Lobster/brown	-78		
		White/beige	-78		
	911 521 001 82 5ZU	Cork/brown			
		White/beige			
	911 521 001 82 8ZZ	Black-red			
		Blue/black			
	911 521 001 82 2ZZ	Black/green			
		Blue/black			
	911 521 001 82 4ZZ	Black/brown			
		White/beige			
	911 521 001 82 4ZS	Brown/brown	79-		
		White/beige	79-		
	911 521 001 82 8ZE	Dark blue/ Red/blue/black			
	911 521 001 82 2ZE	Dark blue/ Green/blue/black			
	911 521 001 82 4ZH	Beige/ Brown/white/beige			
(1)	911 521 002 82	Front seat	/R	1	SC
		Leatherette/ Centre part			

Model: 911 78 Model life 1978>>1983

Pos	Part Number	Description	Remark	Qty	Model
	911 521 002 82 8ZU	Tartan cloth Lobster/brown	-78		
		White/beige	-78		
	911 521 002 82 5ZU	Cork/brown			
		White/beige			
	911 521 002 82 8ZZ	Black-red			
		Blue/black			
	911 521 002 82 2ZZ	Black/green			
		Blue/black			
	911 521 002 82 4ZZ	Black/brown			
		White/beige			
	911 521 002 82 4ZS	Brown/brown	79-		
		White/beige	79-		
	911 521 002 82 8ZE	Dark blue/ Red/blue/black			
	911 521 002 82 2ZE	Dark blue/ Green/blue/black			
	911 521 002 82 4ZH	Beige/ Brown/white/beige			
1	911 521 001 82	Front seat Leatherette/ Centre part Checker board velour	/L 80-	1	SC
	911 521 001 82 3ZP	Black/ Blue/black			
	911 521 001 82 4ZP	Black/ Brown/black			
	911 521 001 82 FD8	Black/ Grey/black			
	911 521 001 82 4ZM	Brown/ Brown/black			
	911 521 001 82 FD9	Brown/ Beige/brown			
	911 521 001 82 BC1	Dark blue/ Blue/black			
	911 521 001 82 4ZG	Beige/ Brown/black			
	911 521 001 82 BC4	Beige/ Beige/brown			
	911 521 001 82 LD5	Black/ Light grey/black	83- 83-		
	911 521 001 82 LJ8	Blue/ Blue-grey	83- 83-		
	911 521 001 82 LD6	Brown/ Brown-grey	83- 83-		
	911 521 001 82 LJ9	Burgundy/ Burgundy-grey	83- 83-		
	911 521 001 82 LK1	Grey-beige/ Light grey/black	83- 83-		
(1)	911 521 002 82	Front seat Leatherette/ Centre part Checker board velour	/R 80-	1	SC
	911 521 002 82 3ZP	Black/ Blue/black			
	911 521 002 82 4ZP	Black/ Brown/black			
	911 521 002 82 FD8	Black/ Grey/black			
	911 521 002 82 4ZM	Brown/ Brown/black			
	911 521 002 82 FD9	Brown/ Beige/brown			

Model: 911 78 Model life 1978>>1983

Pos	Part Number	Description	Remark	Qty	Model
	911 521 002 82 BC1	Dark blue/ Blue/black			
	911 521 002 82 4ZG	Beige/ Brown/black			
	911 521 002 82 BC4	Beige/ Beige/brown			
	911 521 002 82 LD5	Black/ Light grey/black	83-		
	911 521 002 82 LJ8	Blue/ Blue-grey	83-		
	911 521 002 82 LD6	Brown/ Brown-grey	83-		
	911 521 002 82 LJ9	Burgundy/ Burgundy-grey	83-		
	911 521 002 82 LK1	Grey-beige/ Light grey/black	83-		
1	911 521 001 82	Front seat Leatherette/ Centre part Uni-coloured cloth	/L 80-	1	SC
	911 521 001 82 BD4	Black/black	-82		
	911 521 001 82 4ZK	Brown/brown	-82		
	911 521 001 82 BD1	Dark blue/blue	-82		
	911 521 001 82 BD3	Beige/Beige			
	911 521 001 82 BD5	Brown/beige			
	911 521 001 82 LK3	Brown-brown	83-		
	911 521 001 82 LK5	Burgundy-burgundy	83-		
	911 521 001 82 LK6	Grey-beige/grey-beige	83-		
	911 521 001 82 JM2	Black-black	83-		
	911 521 001 82 JM5	Blue/blue	83-		
(1)	911 521 002 82	Front seat Leatherette/ Centre part Uni-coloured cloth	/R 80-	1	SC
	911 521 002 82 BD4	Black/black	-82		
	911 521 002 82 4ZK	Brown/brown	-82		
	911 521 002 82 BD1	Dark blue/blue	-82		
	911 521 002 82 BD3	Beige/Beige			
	911 521 002 82 BD5	Brown/beige			
	911 521 002 82 LK3	Brown-brown	83-		
	911 521 002 82 LK5	Burgundy-burgundy	83-		
	911 521 002 82 LK6	Grey-beige/grey-beige	83-		
	911 521 002 82 JM2	Black-black	83-		
	911 521 002 82 JM5	Blue/blue	83-		
1	911 521 001 83	Front seat Leatherette/ Seat and backrest surface Tartan cloth	/L -78	1	SC
	911 521 001 83 8ZU	Lobster/brown	-78		
	911 521 001 83 5ZU	White/beige Cork/brown			
	911 521 001 83 8ZZ	White/beige Black-red Blue/black			
	911 521 001 83 2ZZ	Black/green Blue/black			
	911 521 001 83 4ZZ	Black/brown White/beige			
(1)	911 521 002 83	Front seat Leatherette/ Seat and backrest surface Tartan cloth	/R -78	1	SC
	911 521 002 83 8ZU	Lobster/brown	-78		

Model: 911 78 Model life 1978>>1983

Pos	Part Number	Description	Remark	Qty	Model
	911 521 002 83 5ZU	White/beige Cork/brown	-78		
	911 521 002 83 8ZZ	White/beige Black-red			
	911 521 002 83 2ZZ	Blue/black Black/green			
	911 521 002 83 4ZZ	Blue/black Black/brown			
1	911 521 001 83	White/beige Front seat Leatherette/ Seat and backrest surface Berber cloth	/L	1	SC
	911 521 001 83 GE9	Black/ Grey/black	81- -82		
	911 521 001 83 BD7	Dark blue/ Blue/black	-82 -82		
	911 521 001 83 FE3	Brown/ Beige/brown	-82 -82		
	911 521 001 83 BD9	Beige/ Beige/brown	-82		
	911 521 001 83 LK8	Burgundy/ Burgundy-grey	83- 83-		
	911 521 001 83 JM9	Grey-beige/ Grey-beige-grey	83- 83-		
	911 521 001 83 JM3	Black/ Grey/black	83- 83-		
	911 521 001 83 JM8	Blue/ Blue/black	83- 83-		
	911 521 001 83 JM4	Brown/ Beige/brown	83- 83-		
(1)	911 521 002 83	Front seat Leatherette/ Seat and backrest surface Berber cloth	/R	1	SC
	911 521 002 83 GE9	Black/ Grey/black	81- -82		
	911 521 002 83 BD7	Dark blue/ Blue/black	-82 -82		
	911 521 002 83 FE3	Brown/ Beige/brown	-82 -82		
	911 521 002 83 BD9	Beige/ Beige/brown	-82		
	911 521 002 83 LK8	Burgundy/ Burgundy-grey	83- 83-		
	911 521 002 83 JM9	Grey-beige/ Grey-beige-grey	83- 83-		
	911 521 002 83 JM3	Black/ Grey/black	83- 83-		
	911 521 002 83 JM8	Blue/ Blue/black	83- 83-		
	911 521 002 83 JM4	Brown/ Beige/brown	83- 83-		
1	911 521 001 84	Front seat Leather	/L	1	
	911 521 001 84 8BB	Lobster	-78		
	911 521 001 84 5BB	Cork	-79		
	911 521 001 84 7BA	Black	-79		
	911 521 001 84 20B	Dark green	-82		
	911 521 001 84 2BF	Light green	-78		
	911 521 001 84 40A	Brown	-81		
	911 521 001 84 3BA	Blue	-79		
	911 521 001 84 8BM	Light red	-79		

Model: 911 78 Model life 1978>>1983

Pos	Part Number	Description	Remark	Qty	Model
	911 521 001 84 1BA	Yellow	-79		
	911 521 001 84 9BA	White	-79		
	911 521 001 84 70A	Black	80-81		
	911 521 001 84 30B	Dark blue	80-82		
	911 521 001 84 50B	Beige	80-		
	911 521 001 84 40D	Cork	80		
	911 521 001 84 30A	Blue	80		
	911 521 001 84 80B	Light red	80		
	911 521 001 84 10A	Yellow	80		
	911 521 001 84 99A	White	80		
	911 521 001 84 80S	Can-can-red	81-82		
	911 521 001 84 95S	Papyrus	81-		
	911 521 001 84 60S	Hannibal grey	81-		
	911 521 001 84 20S	Mint green	81-		
	911 521 001 84 1AJ	Black	82		
	911 521 001 84 3NG	Brown	82		
	911 521 001 84 LG7	Burgundy	83-		
	911 521 001 84 LG4	Pearl white	83-		
	911 521 001 84 LG5	Champagne	83-		
	911 521 001 84 LG6	Dark green	83-		
	911 521 001 84 KZ2	Black	83-		
	911 521 001 84 KZ3	Blue	83-		
	911 521 001 84 KZ4	Grey-beige	83-		
	911 521 001 84 KZ5	Brown	83-		
	911 521 001 84 KZ6	Can-can-red	83-		
(1)	911 521 002 84	Front seat Leather	/R	1	
	911 521 002 84 8BB	Lobster	-78		
	911 521 002 84 5BB	Cork	-79		
	911 521 002 84 7BA	Black	-79		
	911 521 002 84 20B	Dark green	-82		
	911 521 002 84 2BF	Light green	-78		
	911 521 002 84 40A	Brown	-81		
	911 521 002 84 3BA	Blue	-79		
	911 521 002 84 8BM	Light red	-79		
	911 521 002 84 1BA	Yellow	-79		
	911 521 002 84 9BA	White	-79		
	911 521 002 84 70A	Black	80-81		
	911 521 002 84 30B	Dark blue	80-82		
	911 521 002 84 50B	Beige	80-		
	911 521 002 84 40D	Cork	80		
	911 521 002 84 30A	Blue	80		
	911 521 002 84 80B	Light red	80		
	911 521 002 84 10A	Yellow	80		
	911 521 002 84 99A	White	80		
	911 521 002 84 80S	Can-can-red	81-82		
	911 521 002 84 95S	Papyrus	81-		
	911 521 002 84 60S	Hannibal grey	81-		
	911 521 002 84 20S	Mint green	81-		
	911 521 002 84 1AJ	Black	82		
	911 521 002 84 3NG	Brown	82		
	911 521 002 84 LG7	Burgundy	83-		
	911 521 002 84 LG4	Pearl white	83-		
	911 521 002 84 LG5	Champagne	83-		
	911 521 002 84 LG6	Dark green	83-		
	911 521 002 84 KZ2	Black	83-		
	911 521 002 84 KZ3	Blue	83-		
	911 521 002 84 KZ4	Grey-beige	83-		
	911 521 002 84 KZ5	Brown	83-		
	911 521 002 84 KZ6	Can-can-red	83-		
1	911 521 001 85	Front seat Leather/ Centre part	/L	1	

Model: 911 78 Model life 1978>>1983

Pos	Part Number	Description	Remark	Qty	Model
	911 521 001 85 8AK	Pin stripe velour Lobster/lobster	-78		
	911 521 001 85 5AK	Cork/cork			
	911 521 001 85 7AK	Black/black			
	911 521 001 85 8ZT	Black/lobster			
	911 521 001 85 5ZT	Black/cork			
	911 521 001 85 5ZR	Brown/cork	79-		
(1)	911 521 002 85	Front seat Leather/ Centre part Pin stripe velour	/R	1	
	911 521 002 85 8AK	Lobster/lobster	-78		
	911 521 002 85 5AK	Cork/cork			
	911 521 002 85 7AK	Black/black			
	911 521 002 85 8ZT	Black/lobster			
	911 521 002 85 5ZT	Black/cork			
	911 521 002 85 5ZR	Brown/cork	79-		
1	911 521 001 85	Front seat Leather/ Centre part Tartan cloth	/L	1	
	911 521 001 85 8ZU	Lobster/brown White/beige	-78 -78		
	911 521 001 85 5ZU	Cork/brown White/beige			
	911 521 001 85 8ZZ	Black-red Blue/black			
	911 521 001 85 2ZZ	Black/green Blue/black			
	911 521 001 85 4ZZ	Black/brown White/beige			
	911 521 001 85 4ZS	Brown/brown White/beige	79- 79-		
	911 521 001 85 8ZE	Dark blue/ Red/blue/black			
	911 521 001 85 2ZE	Dark blue Green/blue/black			
	911 521 001 85 4ZH	Beige/ Brown/white/beige			
(1)	911 521 002 85	Front seat Leather/ Centre part Tartan cloth	/R	1	
	911 521 002 85 8ZU	Lobster/brown White/beige	-78 -78		
	911 521 002 85 5ZU	Cork/brown White/beige			
	911 521 002 85 8ZZ	Black-red Blue/black			
	911 521 002 85 2ZZ	Black/green Blue/black			
	911 521 002 85 4ZZ	Black/brown White/beige			
	911 521 002 85 4ZS	Brown/brown White/beige	79- 79-		
	911 521 002 85 8ZE	Dark blue/ Red/blue/black			
	911 521 002 85 2ZE	Dark blue Green/blue/black			
	911 521 002 85 4ZH	Beige/ Brown/white/beige			
1	911 521 001 85	Front seat Leather/	/L	1	

Model: 911 78 Model life 1978>>1983

Pos	Part Number	Description	Remark	Qty	Model
		Centre part			
		Checker board velour			
	911 521 001 85 3ZP	Black/ Blue/black			
	911 521 001 85 4ZP	Black/ Brown/black			
	911 521 001 85 AJ2	Black/ Grey/black			
	911 521 001 85 4ZM	Brown/ Brown/black			
	911 521 001 85 AJ3	Brown/ Beige/brown			
	911 521 001 85 AJ1	Dark blue/ Blue/black			
	911 521 001 85 4ZG	Beige/ Brown/black			
	911 521 001 85 AJ4	Beige/ Beige/brown			
	911 521 001 85 LH1	Black/ Light grey/black	83-		
	911 521 001 85 LH3	Blue/ Blue-grey	83- 83-		
	911 521 001 85 LH2	Brown/ Brown-grey	83- 83-		
	911 521 001 85 LH4	Burgundy/ Burgundy-grey	83- 83-		
	911 521 001 85 LH6	Grey-beige/ Light grey/black	83- 83-		
(1)	911 521 002 85	Front seat Leather/ Centre part Checker board velour	/R	1	
	911 521 002 85 3ZP	Black/ Blue/black			
	911 521 002 85 4ZP	Black/ Brown/black			
	911 521 002 85 AJ2	Black/ Grey/black			
	911 521 002 85 4ZM	Brown/ Brown/black			
	911 521 002 85 AJ3	Brown/ Beige/brown			
	911 521 002 85 AJ1	Dark blue/ Blue/black			
	911 521 002 85 4ZG	Beige/ Brown/black			
	911 521 002 85 AJ4	Beige/ Beige/brown			
	911 521 002 85 LH1	Black/ Light grey/black	83- 83-		
	911 521 002 85 LH3	Blue/ Blue-grey	83- 83-		
	911 521 002 85 LH2	Brown/ Brown-grey	83- 83-		
	911 521 002 85 LH4	Burgundy/ Burgundy-grey	83- 83-		
	911 521 002 85 LH6	Grey-beige/ Light grey/black	83- 83-		
1	911 521 001 85	Front seat Leather/ Centre part Uni-coloured cloth	/L	1	
	911 521 001 85 AK4	Black/black	-82		

Model: 911 78 Model life 1978>>1983

Pos	Part Number	Description	Remark	Qty	Model
	911 521 001 85 4ZK	Brown/brown			
	911 521 001 85 AK1	Dark blue/blue	-82		
	911 521 001 85 AK3	Beige/Beige			
	911 521 001 85 AK5	Brown/beige			
	911 521 001 85 LJ1	Brown-brown	83-		
	911 521 001 85 LJ2	Burgundy-burgundy	83-		
	911 521 001 85 LJ3	Grey-beige/grey-beige	83-		
	911 521 001 85 JN6	Black-black	83-		
	911 521 001 85 JT4	Blue/blue	83-		
(1)	911 521 002 85	Front seat Leather/ Centre part Uni-coloured cloth	/R	1	
	911 521 002 85 AK4	Black/black	-82		
	911 521 002 85 4ZK	Brown/brown			
	911 521 002 85 AK1	Dark blue/blue	-82		
	911 521 002 85 AK3	Beige/Beige			
	911 521 002 85 AK5	Brown/beige			
	911 521 002 85 LJ1	Brown-brown	83-		
	911 521 002 85 LJ2	Burgundy-burgundy	83-		
	911 521 002 85 LJ3	Grey-beige/grey-beige	83-		
	911 521 002 85 JN6	Black-black	83-		
	911 521 002 85 JT4	Blue/blue	83-		
1	911 521 001 85	Front seat Leather/ Centre part Stripe design	/L	1	
	911 521 001 85 HS6	Burgundy/ Grey-burgundy			
(1)	911 521 002 85	Front seat Leather/ Centre part Stripe design	/R	1	
	911 521 002 85 HS6	Burgundy/ Grey-burgundy			
1	930 521 001 61	Front seat Leather/ Centre part Tartan cloth	/L -78	1	
	930 521 001 61 8ZU	Lobster/brown White/beige			
	930 521 001 61 5ZU	Cork/brown White/beige			
	930 521 001 61 8ZZ	Black-red Blue/black			
	930 521 001 61 2ZZ	Black/green Blue/black			
	930 521 001 61 4ZZ	Black/brown White/beige			
(1)	930 521 002 61	Front seat Leather/ Centre part Tartan cloth	/R -78	1	
	930 521 002 61 8ZU	Lobster/brown White/beige			
	930 521 002 61 5ZU	Cork/brown White/beige			
	930 521 002 61 8ZZ	Black-red Blue/black			
	930 521 002 61 2ZZ	Black/green Blue/black			
	930 521 002 61 4ZZ	Black/brown White/beige			

Model: 911 78 Model life 1978>>1983

Pos	Part Number	Description	Remark	Qty	Model
1	930 521 001 20	Front seat Leather/ Seat and backrest surface Tartan cloth	/L	1	
	930 521 001 20 8ZU	Lobster/brown White/beige	-78 -78		
	930 521 001 20 5ZU	Cork/brown White/beige			
	930 521 001 20 8ZZ	Black-red Blue/black			
	930 521 001 20 2ZZ	Black/green Blue/black			
	930 521 001 20 4ZZ	Black/brown White/beige			
1	930 521 002 20	Front seat Leather/ Seat and backrest surface Tartan cloth	/R	1	
	930 521 002 20 8ZU	Lobster/brown White/beige	-78 -78		
	930 521 002 20 5ZU	Cork/brown White/beige			
	930 521 002 20 8ZZ	Black-red Blue/black			
	930 521 002 20 2ZZ	Black/green Blue/black			
	930 521 002 20 4ZZ	Black/brown White/beige			
1	930 521 001 20	Front seat Leather/ Seat and backrest surface Berber cloth	/L	1	
	930 521 001 20 AK6	Black/ Grey/black	-82 -82		
	930 521 001 20 AK7	Dark blue/ Blue/black	-82 -82		
	930 521 001 20 AK8	Brown/ Beige/brown	-82 -82		
	930 521 001 20 AK9	Beige/ Beige/brown			
	930 521 001 20 LH8	Burgundy/ Burgundy-grey	83- 83-		
	930 521 001 20 LH9	Grey-beige/ Grey-beige-grey	83- 83-		
	930 521 001 20 JH1	Black/ Grey/black	83- 83-		
	930 521 001 20 JD4	Blue/ Blue/black	83- 83-		
	930 521 001 20 JH2	Brown/ Beige/brown	83- 83-		
1	930 521 002 20	Front seat Leather/ Seat and backrest surface Berber cloth	/R	1	
	930 521 002 20 AK6	Black/ Grey/black	-82 -82		
	930 521 002 20 AK7	Dark blue/ Blue/black	-82 -82		
	930 521 002 20 AK8	Brown/ Beige/brown	-82 -82		
	930 521 002 20 AK9	Beige/ Beige/brown			
	930 521 002 20 LH8	Burgundy/ Burgundy-grey	83- 83-		

Model: 911 78 Model life 1978>>1983

Pos	Part Number	Description	Remark	Qty	Model
	930 521 002 20 LH9	Burgundy-grey Grey-beige/ Grey-beige-grey	83- 83- 83-		
	930 521 002 20 JH1	Black/ Grey/black	83- 83-		
	930 521 002 20 JD4	Blue/ Blue/black	83- 83-		
	930 521 002 20 JH2	Brown/ Beige/brown	83- 83-		
2	911 521 371 00	Screw Inner		2	
3	911 521 547 00	Screw M 10 X 20		4	
4	911 521 359 02	Cover	/L	1	
(4)	911 521 360 02	Cover	/R	1	
5	911 521 571 00	Tensioning spring		2	
(6)	911 521 381 02	Cover for backrest adjustment Comprising: POS. 6 Shifting wheel POS. 7 Cover		2	
6	911 521 381 00	Shifting wheel		2	
6	911 521 381 02	Cover		2	
7	911 521 383 00	Cover		2	
7	911 521 381 02	Cover		2	
8	311 881 607 A	Cover Actuating lever		2	
9	311 881 247	Clip		2	
10	113 881 633 E	Control button		2	
	113 881 633 E 01C	Satin black			
11	928 521 489 02	Seat rail with locking device	/L	1	
(11)	928 521 490 02	Seat rail with locking device	/R	1	
12	911 521 533 01	Handle for longitudinal adjustment		2	
	911 521 533 01 01C	Satin black			
13	944 521 491 00	Seat rail without locking device See TPI		2	
14	N 014 761 2	GR.8 NR.34 Pan-head screw M 6 X 12		8	
14	900 119 129 01	Pan-head screw M 6 X 12		8	
15	N 012 006 4	Lock ring B 6		16	
16	900 075 057 02	Hexagon-head bolt M 6 X 16		8	
16	900 075 057 03	Hexagon-head bolt M 6 X 16		8	
17	900 012 123 00	Pin A 2,5 X 12		2	

Model: 911 78

Model life 1978>>1983

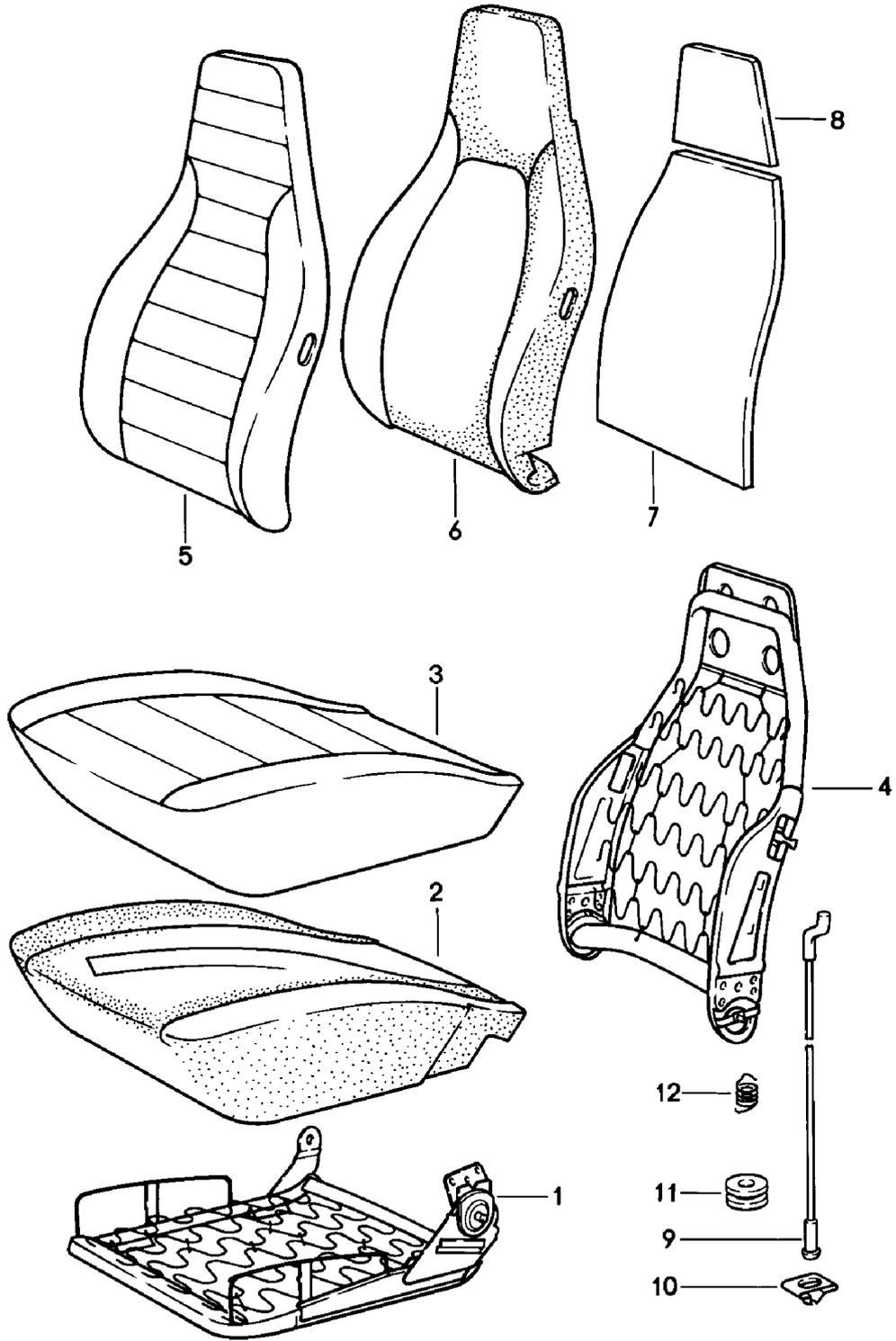

Model: 911 78 Model life 1978>>1983

Pos	Part Number	Description	Remark	Qty	Model
		Front seat			
		Single parts			
1	911 521 069 56	Seat frame	/L	1	
(1)	911 521 070 56	Seat frame	/R	1	
2	911 521 385 02	Foam part	/L	1	
		Seat cushion			
(2)	911 521 386 02	Foam part	/R	1	
		Seat cushion			
3	911 521 037 10	Seat cover	/L -80	1	SC
		Leatherette/ Centre part			
		Braided texture			
	911 521 037 10 8AT	Lobster	-78		
	911 521 037 10 5AT	Cork			
	911 521 037 10 7AT	Black			
	911 521 037 10 4AT	Brown	79-		
(3)	911 521 038 10	Seat cover	/R -80	1	SC
		Leatherette/ Centre part			
		Braided texture			
	911 521 038 10 8AT	Lobster	-78		
	911 521 038 10 5AT	Cork			
	911 521 038 10 7AT	Black			
	911 521 038 10 4AT	Brown	79-		
3	911 521 037 11	Cover for cushion	/L	1	SC
		Leatherette/ Centre part			
		Pin stripe velour			
	911 521 037 11 8AK	Lobster/lobster	-78		
	911 521 037 11 5AK	Cork/cork			
	911 521 037 11 7AK	Black/black			
	911 521 037 11 8ZT	Black/lobster			
	911 521 037 11 5ZT	Black/cork			
	911 521 037 11 5ZQ	Brown/cork	79-		
(3)	911 521 038 11	Cover for cushion	/R	1	SC
		Leatherette/ Centre part			
		Pin stripe velour			
	911 521 038 11 8AK	Lobster/lobster	-78		
	911 521 038 11 5AK	Cork/cork			
	911 521 038 11 7AK	Black/black			
	911 521 038 11 8ZT	Black/lobster			
	911 521 038 11 5ZT	Black/cork			
	911 521 038 11 5ZQ	Brown/cork	79-		
3	911 521 037 11	Cover for cushion	/L	1	SC
		Leatherette/ Centre part			
		Tartan cloth			
	911 521 037 11 8ZU	Lobster/brown	-78		
		White/beige	-78		
	911 521 037 11 5ZU	Cork/brown			
		White/beige			
	911 521 037 11 8ZZ	Black-red			
		Blue/black			
	911 521 037 11 2ZZ	Black/green			
		Blue/black			
	911 521 037 11 4ZZ	Black/brown			
		White/beige			
	911 521 037 11 4ZS	Brown/brown	79-		
		White/beige	79-		
	911 521 037 11 8ZE	Dark blue/ Red/blue/black			
	911 521 037 11 2ZE	Dark blue/			

Model: 911 78

Model life 1978>>1983

Pos	Part Number	Description	Remark	Qty	Model
	911 521 037 11 4ZH	Green/blue/black Beige/ Brown/white/beige			
(3)	911 521 038 11	Cover for cushion Leatherette/ Centre part Tartan cloth	/R	1	SC
	911 521 038 11 8ZU	Lobster/brown White/beige	-78 -78		
	911 521 038 11 5ZU	Cork/brown White/beige			
	911 521 038 11 8ZZ	Black-red Blue/black			
	911 521 038 11 2ZZ	Black/green Blue/black			
	911 521 038 11 4ZZ	Black/brown White/beige			
	911 521 038 11 4ZS	Brown/brown White/beige	79- 79-		
	911 521 038 11 8ZE	Dark blue/ Red/blue/black			
	911 521 038 11 2ZE	Dark blue/ Green/blue/black			
3	911 521 037 11	Beige/ Brown/white/beige Cover for cushion Leatherette/ Centre part Checker board velour	/L 80-	1	SC
	911 521 037 11 3ZP	Black/ Blue/black			
	911 521 037 11 4ZP	Black/ Brown/black			
	911 521 037 11 FD8	Black/ Grey/black			
	911 521 037 11 4ZM	Brown/ Brown/black			
	911 521 037 11 FD9	Brown/ Beige/brown			
	911 521 037 11 BC1	Blue/ Blue/black			
	911 521 037 11 4ZG	Beige/ Brown/black			
	911 521 037 11 BC4	Beige/ Beige/brown			
	911 521 037 11 LD5	Black/ Light grey/black	83- 83-		
	911 521 037 11 LJ8	Blue/ Blue-grey	83- 83-		
	911 521 037 11 LD6	Brown/ Brown-grey	83- 83-		
	911 521 037 11 LJ9	Burgundy/ Burgundy-grey	83- 83-		
	911 521 037 11 LK1	Grey-beige/ Light grey/black	83- 83-		
(3)	911 521 038 11	Cover for cushion Leatherette/ Centre part Checker board velour	/R 80-	1	SC
	911 521 038 11 3ZP	Black/ Blue/black			
	911 521 038 11 4ZP	Black/ Brown/black			

Model: 911 78 Model life 1978>>1983

Pos	Part Number	Description	Remark	Qty	Model
	911 521 038 11 FD8	Black/ Grey/black			
	911 521 038 11 4ZM	Brown/ Brown/black			
	911 521 038 11 FD9	Brown/ Beige/brown			
	911 521 038 11 BC1	Blue/ Blue/black			
	911 521 038 11 4ZG	Beige/ Brown/black			
	911 521 038 11 BC4	Beige/ Beige/brown			
	911 521 038 11 LD5	Black/ Light grey/black	83- 83-		
	911 521 038 11 LJ8	Blue/ Blue-grey	83- 83-		
	911 521 038 11 LD6	Brown/ Brown-grey	83- 83-		
	911 521 038 11 LJ9	Burgundy/ Burgundy-grey	83- 83-		
	911 521 038 11 LK1	Grey-beige/ Light grey/black	83- 83-		
3	911 521 037 11	Cover for cushion Leatherette/ Centre part Uni-coloured cloth	/L	1	SC
	911 521 037 11 BD4	Black/black	-82		
	911 521 037 11 4ZK	Brown/brown	-82		
	911 521 037 11 BD1	Blue/blue			
	911 521 037 11 BD3	Beige/Beige			
	911 521 037 11 BD5	Brown/beige			
	911 521 037 11 LK3	Brown-brown	83-		
	911 521 037 11 LK5	Burgundy-burgundy	83-		
	911 521 037 11 LK6	Grey-beige/grey-beige	83-		
	911 521 037 11 JM2	Black-black	83-		
	911 521 037 11 JM5	Blue/blue	83-		
(3)	911 521 038 11	Cover for cushion Leatherette/ Centre part Uni-coloured cloth	/R	1	SC
	911 521 038 11 BD4	Black/black	-82		
	911 521 038 11 4ZK	Brown/brown	-82		
	911 521 038 11 BD1	Blue/blue			
	911 521 038 11 BD3	Beige/Beige			
	911 521 038 11 BD5	Brown/beige			
	911 521 038 11 LK3	Brown-brown	83-		
	911 521 038 11 LK5	Burgundy-burgundy	83-		
	911 521 038 11 LK6	Grey-beige/grey-beige	83-		
	911 521 038 11 JM2	Black-black	83-		
	911 521 038 11 JM5	Blue/blue	83-		
3	911 521 037 12	Cover for cushion Leatherette/ Seat surface Tartan cloth	/L	1	SC
	911 521 037 12 8ZU	Lobster/brown White/beige	-78 -78		
	911 521 037 12 5ZU	Cork/brown White/beige			
	911 521 037 12 8ZZ	Black-red Blue/black			
	911 521 037 12 2ZZ	Black/green Blue/black			
	911 521 037 12 4ZZ	Black/brown			

Model: 911 78

Model life 1978>>1983

Pos	Part Number	Description	Remark	Qty	Model
(3)	911 521 038 12	White/beige Cover for cushion Leatherette/ Seat surface Tartan cloth	/R	1	SC
	911 521 038 12 8ZU	Lobster/brown White/beige	-78 -78		
	911 521 038 12 5ZU	Cork/brown White/beige			
	911 521 038 12 8ZZ	Black-red Blue/black			
	911 521 038 12 2ZZ	Black/green Blue/black			
	911 521 038 12 4ZZ	Black/brown White/beige			
3	911 521 037 12	Cover for cushion Leatherette/ Seat surface Berber cloth	/L	1	SC
	911 521 037 12 GE9	Black/ Grey/black			
	911 521 037 12 BD7	Blue/black Blue/black	-82 -82		
	911 521 037 12 FE3	Brown/ Beige/brown	-82 -82		
	911 521 037 12 BD9	Beige/ Beige/brown			
	911 521 037 12 LK8	Burgundy/ Burgundy-grey	83- 83-		
	911 521 037 12 JM9	Grey-beige/ Grey-beige-grey	83- 83-		
	911 521 037 12 JM3	Black/ Grey/black	83- 83-		
	911 521 037 12 JM8	Blue/ Blue/black	83- 83-		
	911 521 037 12 JM4	Brown/ Beige/brown	83- 83-		
(3)	911 521 038 12	Cover for cushion Leatherette/ Seat surface Berber cloth	/R	1	SC
	911 521 038 12 GE9	Black/ Grey/black			
	911 521 038 12 BD7	Blue/black Blue/black	-82 -82		
	911 521 038 12 FE3	Brown/ Beige/brown	-82 -82		
	911 521 038 12 BD9	Beige/ Beige/brown			
	911 521 038 12 LK8	Burgundy/ Burgundy-grey	83- 83-		
	911 521 038 12 JM9	Grey-beige/ Grey-beige-grey	83- 83-		
	911 521 038 12 JM3	Black/ Grey/black	83- 83-		
	911 521 038 12 JM8	Blue/ Blue/black	83- 83-		
	911 521 038 12 JM4	Brown/ Beige/brown	83- 83-		
3	911 521 037 13	Cover for cushion Leather	/L	1	
	911 521 037 13 8BB	Lobster	-78		
	911 521 037 13 5BB	Cork	-79		

Model: 911 78 Model life 1978>>1983

Pos	Part Number	Description	Remark	Qty	Model
	911 521 037 13 7BA	Black	-79		
	911 521 037 13 20B	Dark green	-82		
	911 521 037 13 2BF	Light green	-78		
	911 521 037 13 3NG	Brown	-82		
	911 521 037 13 3BA	Blue	-79		
	911 521 037 13 8BM	Light red	-79		
	911 521 037 13 1BA	Yellow	-79		
	911 521 037 13 9BA	White	-79		
	911 521 037 13 1AJ	Black	80-82		
	911 521 037 13 30B	Dark blue	80-82		
	911 521 037 13 50B	Beige	80-		
	911 521 037 13 40D	Cork	80		
	911 521 037 13 30A	Blue	80		
	911 521 037 13 80B	Light red	80		
	911 521 037 13 10A	Yellow	80		
	911 521 037 13 99A	White	80		
	911 521 037 13 80S	Can-can-red	81-82		
	911 521 037 13 95S	Papyrus	81-		
	911 521 037 13 60S	Hannibal grey	81-		
	911 521 037 13 20S	Mint green	81-		
	911 521 037 13 LG7	Burgundy	83-		
	911 521 037 13 LG4	Pearl white	83-		
	911 521 037 13 LG5	Champagne	83-		
	911 521 037 13 LG6	Dark green	83-		
	911 521 037 13 KZ2	Black	83		
	911 521 037 13 KZ3	Blue	83-		
	911 521 037 13 KZ4	Grey-beige	83-		
	911 521 037 13 KZ5	Brown	83-		
	911 521 037 13 KZ6	Can-can-red	83-		
(3)	911 521 038 13	Cover for cushion Leather	/R	1	
	911 521 038 13 8BB	Lobster	-78		
	911 521 038 13 5BB	Cork	-79		
	911 521 038 13 7BA	Black	-79		
	911 521 038 13 20B	Dark green	-82		
	911 521 038 13 2BF	Light green	-78		
	911 521 038 13 3NG	Brown	-82		
	911 521 038 13 3BA	Blue	-79		
	911 521 038 13 8BM	Light red	-79		
	911 521 038 13 1BA	Yellow	-79		
	911 521 038 13 9BA	White	-79		
	911 521 038 13 1AJ	Black	80-82		
	911 521 038 13 30B	Dark blue	80-82		
	911 521 038 13 50B	Beige	80-		
	911 521 038 13 40D	Cork	80		
	911 521 038 13 30A	Blue	80		
	911 521 038 13 80B	Light red	80		
	911 521 038 13 10A	Yellow	80		
	911 521 038 13 99A	White	80		
	911 521 038 13 80S	Can-can-red	81-82		
	911 521 038 13 95S	Papyrus	81-		
	911 521 038 13 60S	Hannibal grey	81-		
	911 521 038 13 20S	Mint green	81-		
	911 521 038 13 LG7	Burgundy	83-		
	911 521 038 13 LG4	Pearl white	83-		
	911 521 038 13 LG5	Champagne	83-		
	911 521 038 13 LG6	Dark green	83-		
	911 521 038 13 KZ2	Black	83		
	911 521 038 13 KZ3	Blue	83-		
	911 521 038 13 KZ4	Grey-beige	83-		
	911 521 038 13 KZ5	Brown	83-		
	911 521 038 13 KZ6	Can-can-red	83-		
3	911 521 037 14	Cover for cushion	/L	1	

Model: 911 78 Model life 1978>>1983

Pos	Part Number	Description	Remark	Qty	Model
		Leather/ Centre part Pin stripe velour			
	911 521 037 14 8AK	Lobster/lobster	-78		
	911 521 037 14 5AK	Cork/cork			
	911 521 037 14 7AK	Black/black			
	911 521 037 14 8ZT	Black/lobster			
	911 521 037 14 5ZT	Black/cork			
	911 521 037 14 5ZR	Brown/cork			
(3)	911 521 038 14	Cover for cushion	/R	1	
		Leather/ Centre part Pin stripe velour			
	911 521 038 14 8AK	Lobster/lobster	-78		
	911 521 038 14 5AK	Cork/cork			
	911 521 038 14 7AK	Black/black			
	911 521 038 14 8ZT	Black/lobster			
	911 521 038 14 5ZT	Black/cork			
	911 521 038 14 5ZR	Brown/cork			
3	911 521 037 14	Cover for cushion	/L	1	
		Leather/ Centre part Tartan cloth			
	911 521 037 14 8ZU	Lobster/brown	-78		
		White/beige	-78		
	911 521 037 14 5ZU	Cork/brown			
		White/beige			
	911 521 037 14 8ZZ	Black-red			
		Blue/black			
	911 521 037 14 2ZZ	Black/green			
		Blue/black			
	911 521 037 14 4ZZ	Black/brown			
		White/beige			
	911 521 037 14 4ZS	Brown/brown			
		White/beige			
	911 521 037 14 8ZE	Dark blue/ Red/blue/black			
	911 521 037 14 2ZE	Dark blue/ Green/blue/black			
	911 521 037 14 4ZH	Beige/ Brown/white/beige			
(3)	911 521 038 14	Cover for cushion	/R	1	
		Leather/ Centre part Tartan cloth			
	911 521 038 14 8ZU	Lobster/brown	-78		
		White/beige	-78		
	911 521 038 14 5ZU	Cork/brown			
		White/beige			
	911 521 038 14 8ZZ	Black-red			
		Blue/black			
	911 521 038 14 2ZZ	Black/green			
		Blue/black			
	911 521 038 14 4ZZ	Black/brown			
		White/beige			
	911 521 038 14 4ZS	Brown/brown			
		White/beige			
	911 521 038 14 8ZE	Dark blue/ Red/blue/black			
	911 521 038 14 2ZE	Dark blue/ Green/blue/black			
	911 521 038 14 4ZH	Beige/ Brown/white/beige			

Model: 911 78 Model life 1978>>1983

Pos	Part Number	Description	Remark	Qty	Model
3	911 521 037 14	Cover for cushion Leather/ Centre part	/L 80-	1	
	911 521 037 14 3ZP	Checker board velour Black/ Blue/black			
	911 521 037 14 4ZP	Black/ Brown/black			
	911 521 037 14 AJ2	Black/ Grey/black			
	911 521 037 14 4ZM	Brown/ Brown/black			
	911 521 037 14 AJ3	Brown/ Beige/brown			
	911 521 037 14 AJ1	Dark blue/ Blue/black			
	911 521 037 14 4ZG	Beige/ Brown/black			
	911 521 037 14 AJ4	Beige/ Beige/brown			
	911 521 037 14 LH1	Black/ Light grey/black	83- 83-		
	911 521 037 14 LH3	Blue/ Blue-grey	83- 83-		
	911 521 037 14 LH2	Brown/ Brown-grey	83- 83-		
	911 521 037 14 LH4	Burgundy/ Burgundy-grey	83- 83-		
	911 521 037 14 LH6	Grey-beige/ Light grey/black	83- 83-		
(3)	911 521 038 14	Cover for cushion Leather/ Centre part	/R 80-	1	
	911 521 038 14 3ZP	Checker board velour Black/ Blue/black			
	911 521 038 14 4ZP	Black/ Brown/black			
	911 521 038 14 AJ2	Black/ Grey/black			
	911 521 038 14 4ZM	Brown/ Brown/black			
	911 521 038 14 AJ3	Brown/ Beige/brown			
	911 521 038 14 AJ1	Dark blue/ Blue/black			
	911 521 038 14 4ZG	Beige/ Brown/black			
	911 521 038 14 AJ4	Beige/ Beige/brown			
	911 521 038 14 LH1	Black/ Light grey/black	83- 83-		
	911 521 038 14 LH3	Blue/ Blue-grey	83- 83-		
	911 521 038 14 LH2	Brown/ Brown-grey	83- 83-		
	911 521 038 14 LH4	Burgundy/ Burgundy-grey	83- 83-		
	911 521 038 14 LH6	Grey-beige/ Light grey/black	83- 83-		
3	911 521 037 14	Cover for cushion Leather/ Centre part	/L	1	

Model: 911 78 Model life 1978>>1983

Pos	Part Number	Description	Remark	Qty	Model
		Uni-coloured cloth			
	911 521 037 14 AK4	Black/black	-82		
	911 521 037 14 4ZK	Brown/brown			
	911 521 037 14 AK1	Dark blue/blue	-82		
	911 521 037 14 AK3	Beige/Beige			
	911 521 037 14 AK5	Brown/beige			
	911 521 037 14 LJ1	Brown-brown	83-		
	911 521 037 14 LJ2	Burgundy-burgundy	83-		
	911 521 037 14 LJ3	Grey-beige/grey-beige	83-		
	911 521 037 14 JN6	Black-black	83-		
	911 521 037 14 JT4	Blue/blue	83		
(3)	911 521 038 14	Cover for cushion Leather/ Centre part Uni-coloured cloth	/R	1	
	911 521 038 14 AK4	Black/black	-82		
	911 521 038 14 4ZK	Brown/brown			
	911 521 038 14 AK1	Dark blue/blue	-82		
	911 521 038 14 AK3	Beige/Beige			
	911 521 038 14 AK5	Brown/beige			
	911 521 038 14 LJ1	Brown-brown	83-		
	911 521 038 14 LJ2	Burgundy-burgundy	83-		
	911 521 038 14 LJ3	Grey-beige/grey-beige	83-		
	911 521 038 14 JN6	Black-black	83-		
	911 521 038 14 JT4	Blue/blue	83		
3	911 521 037 14	Cover for cushion Leather/ Centre part Stripe design	/L	1	M403
	911 521 037 14 HS6	Burgundy/ Grey-burgundy			
(3)	911 521 038 14	Cover for cushion Leather/ Centre part Stripe design	/R	1	M403
	911 521 038 14 HS6	Burgundy/ Grey-burgundy			
3	930 521 037 61	Seat cover Leather/ Centre part Tartan cloth	/L -78	1	
	930 521 037 61 8ZU	Lobster/brown White/beige			
	930 521 037 61 5ZU	Cork/brown White/beige			
	930 521 037 61 8ZZ	Black-red Blue/black			
	930 521 037 61 2ZZ	Black/green Blue/black			
	930 521 037 61 4ZZ	Black/brown White/beige			
(3)	930 521 038 61	Seat cover Leather/ Centre part Tartan cloth	/R -78	1	
	930 521 038 61 8ZU	Lobster/brown White/beige			
	930 521 038 61 5ZU	Cork/brown White/beige			
	930 521 038 61 8ZZ	Black-red Blue/black			
	930 521 038 61 2ZZ	Black/green Blue/black			

Model: 911 78 Model life 1978>>1983

Pos	Part Number	Description	Remark	Qty	Model
3	930 521 038 61 4ZZ	Black/brown White/beige			
	930 521 037 10	Cover for cushion Leather/ Seat surface Tartan cloth	/L	1	
	930 521 037 10 8ZU	Lobster/brown White/beige	78 78		
	930 521 037 10 5ZU	Cork/brown White/beige			
	930 521 037 10 8ZZ	Black-red Blue/black			
	930 521 037 10 2ZZ	Black/green Blue/black			
	930 521 037 10 4ZZ	Black/brown White/beige			
	(3) 930 521 038 10	Cover for cushion Leather/ Seat surface Tartan cloth	/R	1	
	930 521 038 10 8ZU	Lobster/brown White/beige	78 78		
	930 521 038 10 5ZU	Cork/brown White/beige			
3	930 521 038 10 8ZZ	Black-red Blue/black			
	930 521 038 10 2ZZ	Black/green Blue/black			
	930 521 038 10 4ZZ	Black/brown White/beige			
	3 930 521 037 10	Cover for cushion Leather/ Seat surface Berber cloth	/L	1	
	930 521 037 10 AK6	Black/ Grey/black	-82 -82		
	930 521 037 10 AK7	Dark blue/ Blue/black	-82 -82		
	930 521 037 10 AK8	Brown/ Beige/brown	-82 -82		
	930 521 037 10 AK9	Beige/ Beige/brown			
	930 521 037 10 LH8	Burgundy/ Burgundy-grey	83- 83-		
	930 521 037 10 LH9	Grey-beige/ Grey-beige-grey	83- 83-		
(3)	930 521 037 10 JH1	Black/ Grey/black	83- 83-		
	930 521 037 10 JD4	Blue/ Blue/black	83- 83-		
	930 521 037 10 JH2	Brown/ Beige/brown	83- 83-		
	(3) 930 521 038 10	Cover for cushion Leather/ Seat surface Berber cloth	/R	1	
	930 521 038 10 AK6	Black/ Grey/black	-82 -82		
	930 521 038 10 AK7	Dark blue/ Blue/black	-82 -82		
	930 521 038 10 AK8	Brown/ Beige/brown	-82 -82		
	930 521 038 10 AK9	Beige/			

Model: 911 78 Model life 1978>>1983

Pos	Part Number	Description	Remark	Qty	Model
	930 521 038 10 LH8	Beige/brown Burgundy/ Burgundy-grey	83- 83-		
	930 521 038 10 LH9	Grey-beige/ Grey-beige-grey	83- 83-		
	930 521 038 10 JH1	Black/ Grey/black	83- 83-		
	930 521 038 10 JD4	Blue/ Blue/black	83- 83-		
	930 521 038 10 JH2	Brown/ Beige/brown	83- 83-		
4	911 521 027 58	Backrest frame	/L	1	
(4)	911 521 028 58	Backrest frame	/R	1	
5	911 521 072 20	Backrest cover Leatherette/ Centre part Braided texture		2	SC
	911 521 072 20 8AT	Lobster	-78		
	911 521 072 20 5AT	Cork			
	911 521 072 20 7AT	Black			
	911 521 072 20 4AT	Brown	79-		
5	911 521 072 21	Backrest cover Leatherette/ Centre part Pin stripe velour		2	SC
	911 521 072 21 8AK	Lobster/lobster	-78		
	911 521 072 21 5AK	Cork/cork			
	911 521 072 21 7AK	Black/black			
	911 521 072 21 8ZT	Black/lobster			
	911 521 072 21 5ZT	Black/cork			
	911 521 072 21 5ZQ	Brown/cork	79-		
5	911 521 072 21	Backrest cover Leatherette/ Centre part Tartan cloth		2	SC
	911 521 072 21 8ZU	Lobster/brown White/beige	-78 -78		
	911 521 072 21 5ZU	Cork/brown White/beige			
	911 521 072 21 8ZZ	Black-red Blue/black			
	911 521 072 21 2ZZ	Black/green Blue/black			
	911 521 072 21 4ZZ	Black/brown White/beige			
	911 521 072 21 4ZS	Brown/brown White/beige	79- 79-		
	911 521 072 21 8ZE	Dark blue/ Red/blue/black			
	911 521 072 21 2ZE	Dark blue Green/blue/black			
	911 521 072 21 4ZH	Beige/ Brown/white/beige			
5	911 521 072 21	Backrest cover Leatherette/ Centre part Checker board velour	80-	2	SC
	911 521 072 21 3ZP	Black/ Blue/black			
	911 521 072 21 4ZP	Black/ Brown/black			
	911 521 072 21 FD8	Black/ Grey/black			

Model: 911 78

Model life 1978>>1983

Pos	Part Number	Description	Remark	Qty	Model
	911 521 072 21 4ZM	Brown/ Brown/black			
	911 521 072 21 FD9	Brown/ Beige/brown			
	911 521 072 21 BC1	Blue/ Blue/black			
	911 521 072 21 4ZG	Beige/ Brown/black			
	911 521 072 21 BC4	Beige/ Beige/brown			
	911 521 072 21 LD5	Black/ Light grey/black	83- 83-		
	911 521 072 21 LJ8	Blue/ Blue-grey	83- 83-		
	911 521 072 21 LD6	Brown/ Brown-grey	83- 83-		
	911 521 072 21 LJ9	Burgundy/ Burgundy-grey	83- 83-		
	911 521 072 21 LK1	Grey-beige/ Light grey/black	83- 83-		
5	911 521 072 21	Backrest cover Leatherette/ Centre part Uni-coloured cloth		2	SC
	911 521 072 21 BD4	Black/black	-82		
	911 521 072 21 4ZK	Brown/brown	-82		
	911 521 072 21 BD1	Blue/blue			
	911 521 072 21 BD3	Beige/Beige			
	911 521 072 21 BD5	Brown-beige			
	911 521 072 21 LK3	Brown-brown	83-		
	911 521 072 21 LK5	Burgundy-burgundy	83-		
	911 521 072 21 LK6	Grey-beige/grey-beige	83-		
	911 521 072 21 JM2	Black/black	83-		
	911 521 072 21 JM5	Blue/blue			
5	911 521 072 22	Backrest cover Leatherette/ Backrest surface Tartan cloth		2	SC
	911 521 072 22 8ZU	Lobster/brown White/beige	-78 -78		
	911 521 072 22 5ZU	Cork/brown White/beige			
	911 521 072 22 8ZZ	Black-red Blue/black			
	911 521 072 22 2ZZ	Black/green Blue/black			
	911 521 072 22 4ZZ	Black/brown White/beige			
5	911 521 072 22	Backrest cover Leatherette/ Backrest surface Berber cloth		2	SC
	911 521 072 22 GE9	Black/ Grey/black	81-		
	911 521 072 22 BD7	Blue/ Blue/black	-82 -82		
	911 521 072 22 FE3	Brown/ Beige/brown	-82 -82		
	911 521 072 22 BD9	Beige/ Beige/brown			
	911 521 072 22 LK8	Burgundy/ Burgundy-grey	83- 83-		
	911 521 072 22 JM9	Grey-beige/	83-		

Model: 911 78 Model life 1978>>1983

Pos	Part Number	Description	Remark	Qty	Model
	911 521 072 22 JM3	Grey-beige-grey Black/ Grey/black	83- 83- 83-		
	911 521 072 22 JM8	Blue/ Blue/black	83- 83-		
	911 521 072 22 JM4	Brown/ Beige/brown	83- 83-		
5	911 521 072 23	Backrest cover Leather		2	
	911 521 072 23 8BB	Lobster	-78		
	911 521 072 23 5BB	Cork	-79		
	911 521 072 23 7BA	Black	-79		
	911 521 072 23 20B	Dark green	-82		
	911 521 072 23 2BF	Light green	-78		
	911 521 072 23 3NG	Brown	-82		
	911 521 072 23 3BA	Blue	-79		
	911 521 072 23 8BM	Light red	-79		
	911 521 072 23 1BA	Yellow	-79		
	911 521 072 23 9BA	White	-79		
	911 521 072 23 1AJ	Black	80-82		
	911 521 072 23 30B	Dark blue	80-82		
	911 521 072 23 50B	Beige	80-		
	911 521 072 23 40D	Cork	80		
	911 521 072 23 30A	Blue	80		
	911 521 072 23 80B	Light red	80		
	911 521 072 23 10A	Yellow	80		
	911 521 072 23 99A	White	80		
	911 521 072 23 80S	Can-can-red	81-82		
	911 521 072 23 95S	Papyrus	81-		
	911 521 072 23 60S	Hannibal grey	81-		
	911 521 072 23 20S	Mint green	81-		
	911 521 072 23 LG7	Burgundy	83-		
	911 521 072 23 LG4	Pearl white	83-		
	911 521 072 23 LG5	Champagne	83-		
	911 521 072 23 LG6	Dark green	83-		
	911 521 072 23 KZ2	Black	83-		
	911 521 072 23 KZ3	Blue	83-		
	911 521 072 23 KZ4	Grey-beige	83-		
	911 521 072 23 KZ5	Brown	83-		
	911 521 072 23 KZ6	Can-can-red	83-		
5	911 521 072 24	Backrest cover Leather/ Centre part Pin stripe velour		2	
	911 521 072 24 8AK	Lobster/lobster	-78		
	911 521 072 24 5AK	Cork/cork			
	911 521 072 24 7AK	Black/black			
	911 521 072 24 8ZT	Black/lobster			
	911 521 072 24 5ZT	Black/cork			
	911 521 072 24 5ZR	Brown/cork	-79		
5	911 521 072 24	Backrest cover Leather/ Centre part Tartan cloth		2	
	911 521 072 24 8ZU	Lobster/brown White/beige	-78 -78		
	911 521 072 24 5ZU	Cork/brown White/beige			
	911 521 072 24 8ZZ	Black-red Blue/black			
	911 521 072 24 2ZZ	Black/green Blue/black			
	911 521 072 24 4ZZ	Black/brown			

Model: 911 78 Model life 1978>>1983

Pos	Part Number	Description	Remark	Qty	Model
	911 521 072 24 4ZS	White/beige Brown/brown	79-		
	911 521 072 24 8ZE	White/beige Dark blue/ Red/blue/black	79-		
	911 521 072 24 2ZE	Dark blue/ Green/blue/black			
	911 521 072 24 4ZH	Beige/ Brown/white/beige			
5	911 521 072 24	Backrest cover Leather/ Centre part Checker board velour	80-	2	
	911 521 072 24 3ZP	Black/ Blue/black			
	911 521 072 24 4ZP	Black/ Brown/black			
	911 521 072 24 AJ2	Black/ Grey/black			
	911 521 072 24 4ZM	Brown/ Brown/black			
	911 521 072 24 AJ3	Brown/ Beige/brown			
	911 521 072 24 AJ1	Dark blue/ Blue/black			
	911 521 072 24 4ZG	Beige/ Brown/black			
	911 521 072 24 AJ4	Beige/ Beige/brown			
	911 521 072 24 LH1	Black/ Light grey/black	83-		
	911 521 072 24 LH3	Blue/ Blue-grey	83-		
	911 521 072 24 LH2	Brown/ Brown-grey	83-		
	911 521 072 24 LH4	Burgundy/ Burgundy-grey	83-		
	911 521 072 24 LH6	Grey-beige/ Light grey/black	83-		
5	911 521 072 24	Backrest cover Leather/ Centre part Uni-coloured cloth	80-	2	
	911 521 072 24 AK4	Black/black	-82		
	911 521 072 24 4ZK	Brown/brown			
	911 521 072 24 AK1	Dark blue/blue	-82		
	911 521 072 24 AK3	Beige/Beige			
	911 521 072 24 AK5	Brown/beige			
	911 521 072 24 LJ1	Brown-brown	83-		
	911 521 072 24 LJ2	Burgundy-burgundy	83-		
	911 521 072 24 LJ3	Grey-beige/grey-beige	83-		
	911 521 072 24 JN6	Black-black	83-		
	911 521 072 24 JT4	Blue/blue	83-		
5	911 521 072 24	Backrest cover Leather Centre part Stripe design		2	M403
	911 521 072 24 HS6	Burgundy/ Grey-burgundy			
5	930 521 072 61	Backrest cover Leather/ Centre part Tartan cloth	-78	1	

Model: 911 78

Model life 1978>>1983

Pos	Part Number	Description	Remark	Qty	Model
	930 521 072 61 8ZU	Lobster/brown White/beige			
	930 521 072 61 5ZU	Cork/brown White/beige			
	930 521 072 61 8ZZ	Black-red Blue/black			
	930 521 072 61 2ZZ	Black/green Blue/black			
	930 521 072 61 4ZZ	Black/brown White/beige			
5	930 521 072 20	Backrest cover Leather/ Backrest surface Tartan cloth		2	
	930 521 072 20 8ZU	Lobster/brown White/beige	-78 -78		
	930 521 072 20 5ZU	Cork/brown White/beige			
	930 521 072 20 8ZZ	Black-red Blue/black			
	930 521 072 20 2ZZ	Black/green Blue/black			
	930 521 072 20 4ZZ	Black/brown White/beige			
5	930 521 072 20	Backrest cover Leather/ Backrest surface Berber cloth		2	
	930 521 072 20 AK6	Black/ Grey/black	81- -82 -82		
	930 521 072 20 AK7	Dark blue/ Blue/black	-82 -82		
	930 521 072 20 AK8	Brown/ Beige/brown	-82 -82		
	930 521 072 20 AK9	Beige/ Beige/brown	-82		
	930 521 072 20 LH8	Burgundy/ Burgundy-grey	83- 83-		
	930 521 072 20 LH9	Grey-beige/grey-beige Grey-beige-grey	83- 83-		
	930 521 072 20 JH1	Black/ Grey/black	83- 83-		
	930 521 072 20 JD4	Blue/ Blue/black	83- 83-		
	930 521 072 20 JH2	Brown/ Beige/brown	83- 83-		
6	911 521 393 02	Foam part Backrest		2	
7	911 521 575 00	Filler piece Backrest frame		2	
8	911 521 435 00	Filler piece		2	
9	911 521 361 00	Wire pull Release Backrest		2	
9	911 521 361 02	Wire pull Release Backrest		2	
10	911 521 369 00	Terminal for Cable		2	
11	911 521 343 00	Guide bush for Cable		2	

Model: 911 78

Model life 1978>>1983

Pos	Part Number	Description	Remark	Qty	Model
12	311 881 287 A	Tension spring for Actuating lever		2	

Model: 911 78

Model life 1978>>1983

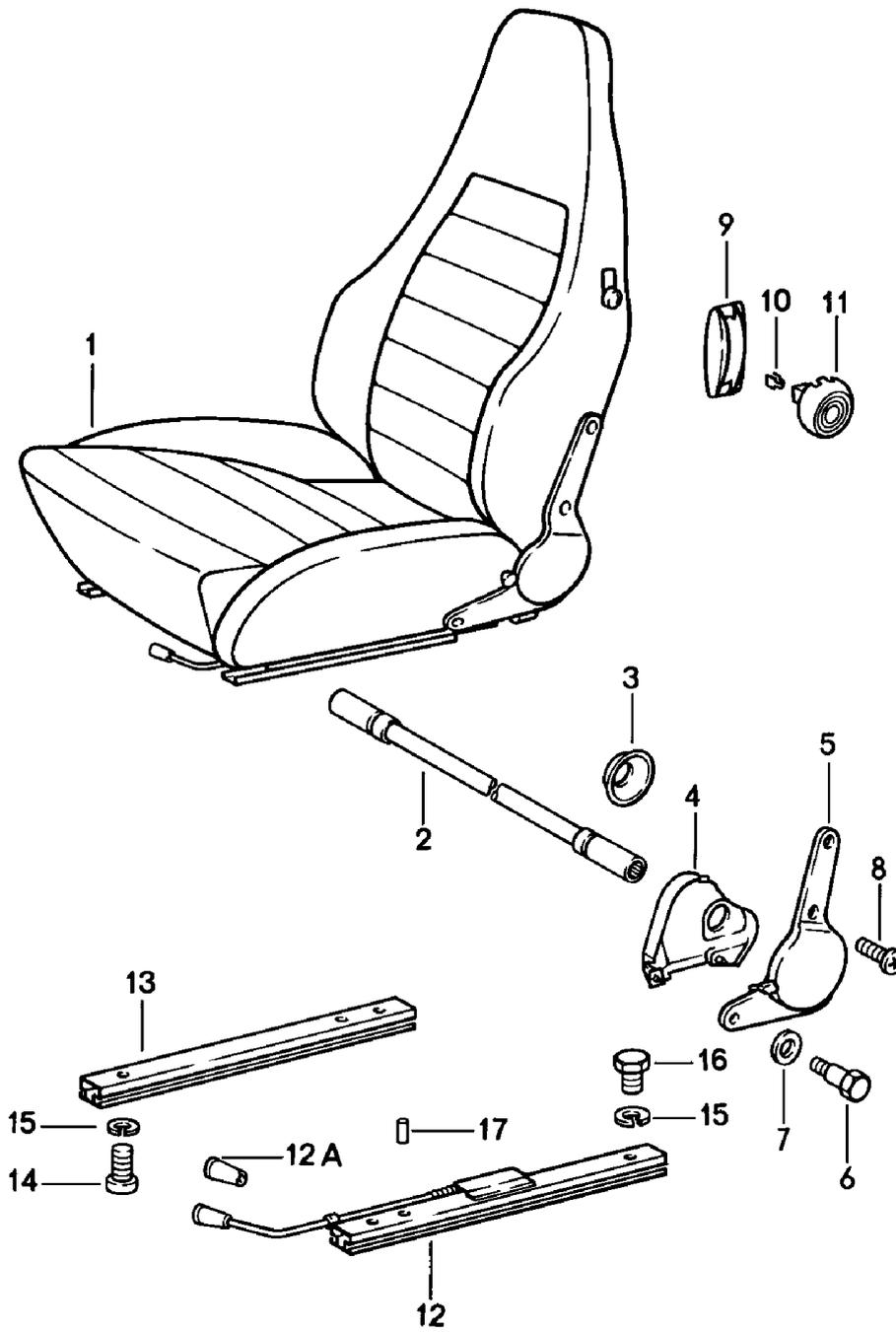

Model: 911 78 Model life 1978>>1983

Pos	Part Number	Description	Remark	Qty	Model
		Sports seat Complete	-80		
1	911 521 007 55	Sports seat Leatherette/ Centre part Pin stripe velour	/L	1	
	911 521 007 55 8AK	Lobster/lobster	-78		
	911 521 007 55 5AK	Cork/cork			
	911 521 007 55 7AK	Black/black			
	911 521 007 55 8ZT	Black/lobster			
	911 521 007 55 5ZT	Black/cork			
	911 521 007 55 5ZQ	Brown/cork	79-		
(1)	911 521 008 55	Sports seat Leatherette/ Centre part Pin stripe velour	/R	1	
	911 521 008 55 8AK	Lobster/lobster	-78		
	911 521 008 55 5AK	Cork/cork			
	911 521 008 55 7AK	Black/black			
	911 521 008 55 8ZT	Black/lobster			
	911 521 008 55 5ZT	Black/cork			
	911 521 008 55 5ZQ	Brown/cork	79-		
1	911 521 007 55	Sports seat Leatherette/ Centre part Tartan cloth	/L	1	
	911 521 007 55 8ZU	Lobster/brown White/beige	-78		
	911 521 007 55 5ZU	Cork/brown White/beige			
	911 521 007 55 8ZZ	Black-red Blue/black			
	911 521 007 55 2ZZ	Black/green Blue/black			
	911 521 007 55 4ZZ	Black/brown White/beige			
	911 521 007 55 4ZS	Brown/brown White/beige	79-		
	911 521 007 55 8ZE	Dark blue/ Red/blue/black			
	911 521 007 55 2ZE	Dark blue/ Green/blue/black			
	911 521 007 55 4ZH	Beige/ Brown/white/beige			
(1)	911 521 008 55	Sports seat Leatherette/ Centre part Tartan cloth	/R	1	
	911 521 008 55 8ZU	Lobster/brown White/beige	-78		
	911 521 008 55 5ZU	Cork/brown White/beige			
	911 521 008 55 8ZZ	Black-red Blue/black			
	911 521 008 55 2ZZ	Black/green Blue/black			
	911 521 008 55 4ZZ	Black/brown White/beige			
	911 521 008 55 4ZS	Brown/brown White/beige	79-		
	911 521 008 55 8ZE	Dark blue/ Red/blue/black			
	911 521 008 55 2ZE	Dark blue/			

Model: 911 78 Model life 1978>>1983

Pos	Part Number	Description	Remark	Qty	Model
	911 521 008 55 4ZH	Green/blue/black			
1	911 521 007 55	Beige/ Brown/white/beige Sports seat Leatherette/ Centre part Checker board velour	/L 80	1	
	911 521 007 55 3ZP	Black/ Blue/black			
	911 521 007 55 4ZP	Black/ Brown/black			
	911 521 007 55 6ZP	Black/ Grey/black			
	911 521 007 55 4ZM	Brown/ Brown/black			
	911 521 007 55 5ZM	Brown/ Beige/brown			
	911 521 007 55 3ZD	Dark blue/ Blue/black			
	911 521 007 55 4ZG	Beige/ Brown/black			
	911 521 007 55 5ZG	Beige/ Beige/brown			
(1)	911 521 008 55	Sports seat Leatherette/ Centre part Checker board velour	/R 80	1	
	911 521 008 55 3ZP	Black/ Blue/black			
	911 521 008 55 4ZP	Black/ Brown/black			
	911 521 008 55 6ZP	Black/ Grey/black			
	911 521 008 55 4ZM	Brown/ Brown/black			
	911 521 008 55 5ZM	Brown/ Beige/brown			
	911 521 008 55 3ZD	Dark blue/ Blue/black			
	911 521 008 55 4ZG	Beige/ Brown/black			
	911 521 008 55 5ZG	Beige/ Beige/brown			
1	911 521 007 55	Sports seat Leatherette/ Centre part Uni-coloured cloth	/L 80	1	
	911 521 007 55 7ZN	Black/black			
	911 521 007 55 4ZK	Brown/brown			
	911 521 007 55 3ZC	Dark blue/blue			
	911 521 007 55 5ZF	Beige/Beige			
(1)	911 521 008 55	Sports seat Leatherette/ Centre part Uni-coloured cloth	/R 80	1	
	911 521 008 55 7ZN	Black/black			
	911 521 008 55 4ZK	Brown/brown			
	911 521 008 55 3ZC	Dark blue/blue			
	911 521 008 55 5ZF	Beige/Beige			
1	911 521 007 56	Sports seat Leatherette/ Centre part Braided texture	/L	1	

Model: 911 78 Model life 1978>>1983

Pos	Part Number	Description	Remark	Qty	Model
	911 521 007 56 8AT	Lobster	-78		
	911 521 007 56 5AT	Cork			
	911 521 007 56 7AT	Black			
	911 521 007 56 4AT	Brown	79-		
	911 521 007 56 50B	Beige			
(1)	911 521 008 56	Sports seat Leatherette/ Centre part Braided texture	/R	1	
	911 521 008 56 8AT	Lobster	-78		
	911 521 008 56 5AT	Cork			
	911 521 008 56 7AT	Black			
	911 521 008 56 4AT	Brown	79-		
	911 521 008 56 50B	Beige			
1	911 521 007 57	Sports seat Leather	/L	1	
	911 521 007 57 8BB	Lobster	-78		
	911 521 007 57 5BB	Cork	-79		
	911 521 007 57 7BA	Black	-79		
	911 521 007 57 20B	Dark green			
	911 521 007 57 2BF	Light green	-78		
	911 521 007 57 40A	Brown			
	911 521 007 57 3BA	Blue	-79		
	911 521 007 57 8BM	Light red	-79		
	911 521 007 57 1BA	Yellow	-79		
	911 521 007 57 9BA	White	-79		
	911 521 007 57 70A	Black	80-		
	911 521 007 57 30B	Dark blue	80-		
	911 521 007 57 50B	Beige	80-		
	911 521 007 57 40D	Cork	80-		
	911 521 007 57 30A	Blue	80-		
	911 521 007 57 80B	Light red	80-		
	911 521 007 57 10A	Yellow	80-		
	911 521 007 57 99A	White	80-		
(1)	911 521 008 57	Sports seat Leather	/R	1	
	911 521 008 57 8BB	Lobster	-78		
	911 521 008 57 5BB	Cork	-79		
	911 521 008 57 7BA	Black	-79		
	911 521 008 57 20B	Dark green			
	911 521 008 57 2BF	Light green	-78		
	911 521 008 57 40A	Brown			
	911 521 008 57 3BA	Blue	-79		
	911 521 008 57 8BM	Light red	-79		
	911 521 008 57 1BA	Yellow	-79		
	911 521 008 57 9BA	White	-79		
	911 521 008 57 70A	Black	80-		
	911 521 008 57 30B	Dark blue	80-		
	911 521 008 57 50B	Beige	80-		
	911 521 008 57 40D	Cork	80-		
	911 521 008 57 30A	Blue	80-		
	911 521 008 57 80B	Light red	80-		
	911 521 008 57 10A	Yellow	80-		
	911 521 008 57 99A	White	80-		
2	911 521 045 03	Connecting rod		2	
3	911 521 147 01	Cap		2	
4	911 521 731 00	Inner part	/L	1	
(4)	911 521 732 00	Inner part	/R	1	
5	911 521 041 03	Reclining seat fitting Left seat with Control lever	/L	1	
(5)	911 521 042 03	Reclining seat fitting	/R	1	

Model: 911 78 Model life 1978>>1983

Pos	Part Number	Description	Remark	Qty	Model
(5)	911 521 044 03	Right seat with Control lever Reclining seat fitting	/R	1	
(5)	911 521 043 03	Left seat without Control lever Reclining seat fitting	/L	1	
6	911 521 695 00	Hexagon-head bolt		4	
7	911 521 130 01	Washer		4	
8	900 270 033 02	Lens-head screw M 8 X 30		8	
9	311 881 607 A	Cover		2	
10	311 881 247	Clip		2	
11	113 881 633 E	Control button		2	
	113 881 633 E 01C	Satin black			
12	928 521 489 02	Seat rail	/L	1	
(12)	928 521 490 02	Seat rail	/R	1	
(12A)	911 521 533 01	Handle for longitudinal adjustment		2	
	911 521 533 01 01C	Satin black			
13	944 521 491 00	Seat rail without locking device See TPI GR.8 NR.34		2	
13		Seat rail		2	
14	900 186 018 02	Pan-head screw M 6 X 20		8	
15	N 012 006 4	Lock ring B 6		16	
16	900 075 057 02	Hexagon-head bolt M 6 X 16		8	
16	900 075 057 03	Hexagon-head bolt M 6 X 16		8	
17	900 012 123 00	Pin A 2,5 X 12		2	

Model: 911 78

Model life 1978>>1983

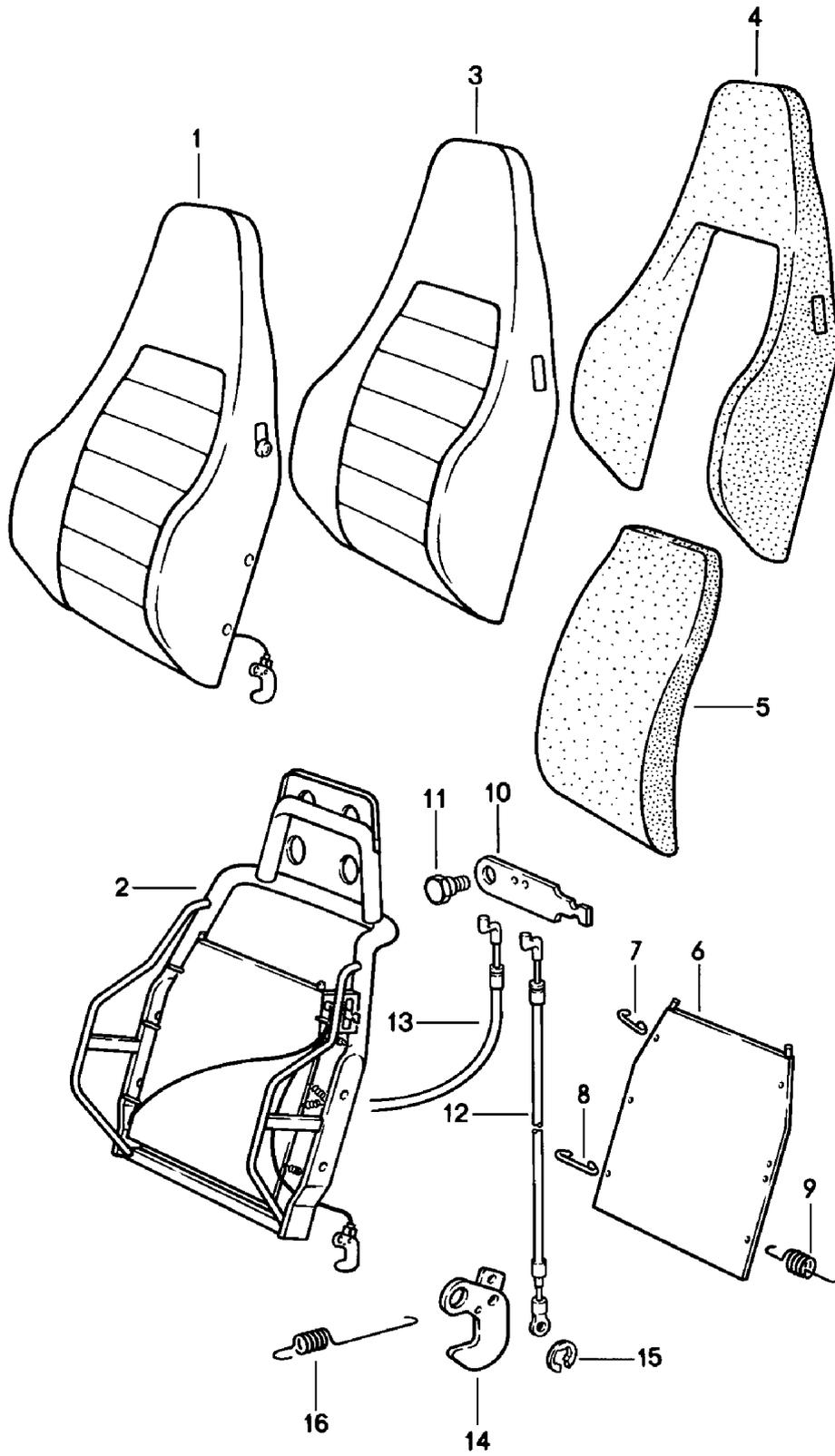

Model: 911 78 Model life 1978>>1983

Pos	Part Number	Description	Remark	Qty	Model
1	911 521 603 00	Sports seat Backrest Single parts Backrest Leatherette/ Centre part Pin stripe velour	-80 /L	1	
	911 521 603 00 8AK	Lobster/lobster	-78		
	911 521 603 00 5AK	Cork/cork			
	911 521 603 00 7AK	Black/black			
	911 521 603 00 8ZT	Black/lobster			
	911 521 603 00 5ZT	Black/cork			
	911 521 603 00 5ZQ	Brown/cork	79-		
(1)	911 521 604 00	Backrest Leatherette/ Centre part Pin stripe velour	/R	1	
	911 521 604 00 8AK	Lobster/lobster	-78		
	911 521 604 00 5AK	Cork/cork			
	911 521 604 00 7AK	Black/black			
	911 521 604 00 8ZT	Black/lobster			
	911 521 604 00 5ZT	Black/cork			
	911 521 604 00 5ZQ	Brown/cork	79-		
1	911 521 603 00	Backrest Leatherette/ Centre part Tartan cloth	/L	1	
	911 521 603 00 8ZU	Lobster/brown White/beige	-78		
	911 521 603 00 5ZU	Cork/brown White/beige			
	911 521 603 00 8ZZ	Black-red Blue/black			
	911 521 603 00 2ZZ	Black/green Blue/black			
	911 521 603 00 4ZZ	Black/brown White/beige			
	911 521 603 00 4ZS	Brown/brown White/beige	79-		
	911 521 603 00 8ZE	Dark blue/ Red/blue/black			
	911 521 603 00 2ZE	Dark blue/ Green/blue/black			
	911 521 603 00 4ZH	Beige/ Brown/white/beige			
(1)	911 521 604 00	Backrest Leatherette/ Centre part Tartan cloth	/R	1	
	911 521 604 00 8ZU	Lobster/brown White/beige	-78		
	911 521 604 00 5ZU	Cork/brown White/beige			
	911 521 604 00 8ZZ	Black-red Blue/black			
	911 521 604 00 2ZZ	Black/green Blue/black			
	911 521 604 00 4ZZ	Black/brown White/beige			
	911 521 604 00 4ZS	Brown/brown White/beige	79-		
	911 521 604 00 8ZE	Dark blue/ Red/blue/black			

Model: 911 78 Model life 1978>>1983

Pos	Part Number	Description	Remark	Qty	Model
1	911 521 604 00 2ZE	Dark blue/ Green/blue/black			
	911 521 604 00 4ZH	Beige/ Brown/white/beige			
	911 521 603 00	Backrest Leatherette/ Centre part Checker board velour	/L 80	1	
	911 521 603 00 3ZP	Black/ Blue/black			
	911 521 603 00 4ZP	Black/ Brown/black			
	911 521 603 00 6ZP	Black/ Grey/black			
	911 521 603 00 4ZM	Brown/ Brown/black			
	911 521 603 00 5ZM	Brown/ Beige/brown			
	911 521 603 00 3ZD	Dark blue/ Blue/black			
	911 521 603 00 4ZG	Beige/ Brown/black			
(1)	911 521 603 00 5ZG	Beige/ Beige/brown			
	911 521 604 00	Backrest Leatherette/ Centre part Checker board velour	/R 80	1	
	911 521 604 00 3ZP	Black/ Blue/black			
	911 521 604 00 4ZP	Black/ Brown/black			
	911 521 604 00 6ZP	Black/ Grey/black			
	911 521 604 00 4ZM	Brown/ Brown/black			
	911 521 604 00 5ZM	Brown/ Beige/brown			
	911 521 604 00 3ZD	Dark blue/ Blue/black			
	911 521 604 00 4ZG	Beige/ Brown/black			
	911 521 604 00 5ZG	Beige/ Beige/brown			
1	911 521 603 00	Backrest Leatherette/ Centre part Uni-coloured cloth	/L 80	1	
	911 521 603 00 7ZN	Black/black			
	911 521 603 00 4ZK	Brown/brown			
	911 521 603 00 3ZC	Dark blue/blue			
	911 521 603 00 5ZF	Beige/Beige			
(1)	911 521 604 00	Backrest Leatherette/ Centre part Uni-coloured cloth	/R 80	1	
	911 521 604 00 7ZN	Black/black			
	911 521 604 00 4ZK	Brown/brown			
	911 521 604 00 3ZC	Dark blue/blue			
	911 521 604 00 5ZF	Beige/Beige			
1	911 521 603 01	Backrest Leatherette/ Centre part	/L	1	

Model: 911 78 Model life 1978>>1983

Pos	Part Number	Description	Remark	Qty	Model
		Braided texture			
	911 521 603 01 8AT	Lobster	-78		
	911 521 603 01 5AT	Cork			
	911 521 603 01 7AT	Black			
	911 521 603 01 4AT	Brown	79-		
	911 521 603 01 50B	Beige			
(1)	911 521 604 01	Backrest Leatherette/ Centre part Braided texture	/R	1	
	911 521 604 01 8AT	Lobster	-78		
	911 521 604 01 5AT	Cork			
	911 521 604 01 7AT	Black			
	911 521 604 01 4AT	Brown	79-		
	911 521 604 01 50B	Beige			
1	911 521 603 02	Backrest Leather	/L	1	
	911 521 603 02 8BB	Lobster	-78		
	911 521 603 02 5BB	Cork	-79		
	911 521 603 02 7BA	Black	-79		
	911 521 603 02 20B	Dark green			
	911 521 603 02 2BF	Light green	-78		
	911 521 603 02 40A	Brown			
	911 521 603 02 3BA	Blue	-79		
	911 521 603 02 8BM	Light red	-79		
	911 521 603 02 1BA	Yellow	-79		
	911 521 603 02 9BA	White	-79		
	911 521 603 02 70A	Black	80		
	911 521 603 02 30B	Dark blue	80		
	911 521 603 02 50B	Beige	80		
	911 521 603 02 40D	Cork	80		
	911 521 603 02 30A	Blue	80		
	911 521 603 02 80B	Light red	80		
	911 521 603 02 10A	Yellow	80		
	911 521 603 02 99A	White	80		
(1)	911 521 604 02	Backrest Leather	/R	1	
	911 521 604 02 8BB	Lobster	-78		
	911 521 604 02 5BB	Cork	-79		
	911 521 604 02 7BA	Black	-79		
	911 521 604 02 20B	Dark green			
	911 521 604 02 2BF	Light green	-78		
	911 521 604 02 40A	Brown			
	911 521 604 02 3BA	Blue	-79		
	911 521 604 02 8BM	Light red	-79		
	911 521 604 02 1BA	Yellow	-79		
	911 521 604 02 9BA	White	-79		
	911 521 604 02 70A	Black	80		
	911 521 604 02 30B	Dark blue	80		
	911 521 604 02 50B	Beige	80		
	911 521 604 02 40D	Cork	80		
	911 521 604 02 30A	Blue	80		
	911 521 604 02 80B	Light red	80		
	911 521 604 02 10A	Yellow	80		
	911 521 604 02 99A	White	80		
2	911 521 613 00	Backrest frame	/L	1	
(2)	911 521 614 00	Backrest frame	/R	1	
3	911 521 072 01	Backrest cover Leatherette/ Centre part Pin stripe velour		2	
	911 521 072 01 8AK	Lobster/lobster	-78		
	911 521 072 01 5AK	Cork/cork			

Model: 911 78 Model life 1978>>1983

Pos	Part Number	Description	Remark	Qty	Model
3	911 521 072 01 7AK	Black/black		2	
	911 521 072 01 8ZT	Black/lobster			
	911 521 072 01 5ZT	Black/cork			
	911 521 072 01 5ZQ	Brown/cork	79-		
	911 521 072 01	Backrest cover Leatherette/ Centre part Tartan cloth			
	911 521 072 01 8ZU	Lobster/brown White/beige	-78		
	911 521 072 01 5ZU	Cork/brown White/beige			
	911 521 072 01 8ZZ	Black-red Blue/black			
	911 521 072 01 2ZZ	Black/green Blue/black			
	911 521 072 01 4ZZ	Black/brown White/beige			
	911 521 072 01 4ZS	Brown/brown White/beige	79-		
	911 521 072 01 8ZE	Dark blue/ Red/blue/black			
	911 521 072 01 2ZE	Dark blue/ Green/blue/black			
	911 521 072 01 4ZH	Beige/ Brown/white/beige			
3	911 521 072 01	Backrest cover Leatherette/ Centre part Checker board velour	80	2	
	911 521 072 01 3ZP	Black/ Blue/black			
	911 521 072 01 4ZP	Black/ Brown/black			
	911 521 072 01 6ZP	Black/ Grey/black			
	911 521 072 01 4ZM	Brown/ Brown/black			
	911 521 072 01 5ZM	Brown/ Beige/brown			
	911 521 072 01 3ZD	Dark blue/ Blue/black			
	911 521 072 01 4ZG	Beige/ Brown/black			
	911 521 072 01 5ZG	Beige/ Beige/brown			
	911 521 072 01	Backrest cover Leatherette/ Centre part Uni-coloured cloth	80		
	911 521 072 01 7ZN	Black/black			
	911 521 072 01 4ZK	Brown/brown			
	911 521 072 01 3ZC	Dark blue/blue			
	911 521 072 01 5ZF	Beige/Beige			
3	911 521 072 02	Backrest cover Leatherette/ Centre part Braided texture		2	
	911 521 072 02 8AT	Lobster	-78		
	911 521 072 02 5AT	Cork			
	911 521 072 02 7AT	Black			
	911 521 072 02 4AT	Brown	79-		
	911 521 072 02 50B	Beige			

Model: 911 78 Model life 1978>>1983

Pos	Part Number	Description	Remark	Qty	Model
3	911 521 072 03	Backrest cover Leather		2	
	911 521 072 03 8BB	Lobster	-78		
	911 521 072 03 5BB	Cork	-79		
	911 521 072 03 7BA	Black	-79		
	911 521 072 03 20B	Dark green			
	911 521 072 03 2BF	Light green	-78		
	911 521 072 03 40A	Brown			
	911 521 072 03 3BA	Blue	-79		
	911 521 072 03 8BM	Light red	-79		
	911 521 072 03 1BA	Yellow	-79		
	911 521 072 03 9BA	White	-79		
	911 521 072 03 70A	Black	80-		
	911 521 072 03 30B	Dark blue	80-		
	911 521 072 03 50B	Beige	80-		
	911 521 072 03 40D	Cork	80-		
	911 521 072 03 30A	Blue	80-		
	911 521 072 03 80B	Light red	80-		
	911 521 072 03 10A	Yellow	80		
	911 521 072 03 99A	White	80-		
4	911 521 751 00	Foam part Backrest side bolster		2	
5	911 521 104 02	Foam part Backrest cushion		2	
6	911 521 651 00	Seat belt		2	
7	911 521 693 00	Belt hook Upper		2	
8	911 521 713 00	Belt hook Lower		4	
9	911 521 689 00	Shift spring		8	
10	911 521 721 00	Backrest locking lever		2	
11	911 521 723 00	Shouldered bolt		2	
12	911 521 615 00	Bowden cable Short		2	
13	911 521 616 00	Bowden cable Long		2	
14	911 521 563 00	Locking hook	/L	2	
(14)	911 521 564 00	Locking hook	/R	2	
15	N 012 439 2	Lock washer 8		4	
16	911 521 733 00	Tension spring	/L	1	
(16)	911 521 734 00	Tension spring	/R	1	

Model: 911 78

Model life 1978>>1983

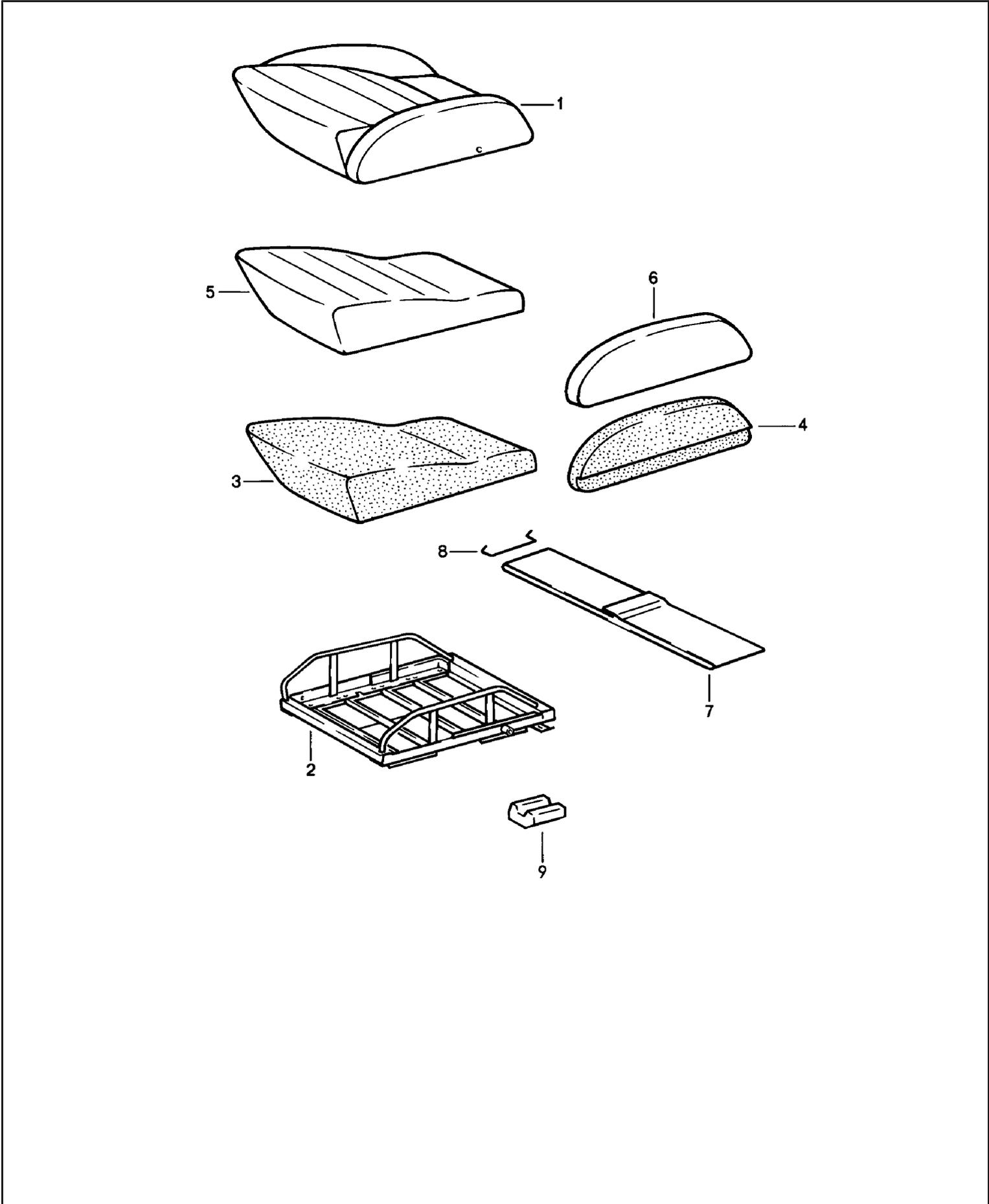

Model: 911 78 Model life 1978>>1983

Pos	Part Number	Description	Remark	Qty	Model
1	911 521 605 00	Sports seat Seat cushion Single parts Seat cushion Leatherette/ Centre part Pin stripe velour	-80	2	
	911 521 605 00 8AK	Lobster/lobster	-78		
	911 521 605 00 5AK	Cork/cork			
	911 521 605 00 7AK	Black/black			
	911 521 605 00 8ZT	Black/lobster			
	911 521 605 00 5ZT	Black/cork			
1	911 521 605 00 5ZQ	Brown/cork	79-	2	
	911 521 605 00	Seat cushion Leatherette/ Centre part Tartan cloth			
	911 521 605 00 8ZU	Lobster/brown White/beige	-78		
	911 521 605 00 5ZU	Cork/brown White/beige			
	911 521 605 00 8ZZ	Black-red Blue/black			
	911 521 605 00 2ZZ	Black/green Blue/black			
	911 521 605 00 4ZZ	Black/brown White/beige			
	911 521 605 00 4ZS	Brown/brown White/beige	79-		
	911 521 605 00 8ZE	Dark blue/ Red/blue/black			
	911 521 605 00 2ZE	Dark blue/ Green/blue/black			
1	911 521 605 00 4ZH	Beige/ Brown/white/beige		2	
	911 521 605 00	Seat cushion Leatherette/ Centre part Checker board velour	80		
	911 521 605 00 3ZP	Black/ Blue/black			
	911 521 605 00 4ZP	Black/ Brown/black			
	911 521 605 00 6ZP	Black/ Grey/black			
	911 521 605 00 4ZM	Brown/ Brown/black			
	911 521 605 00 5ZM	Brown/ Beige/brown			
	911 521 605 00 3ZD	Dark blue/ Blue/black			
	911 521 605 00 4ZG	Beige/ Brown/black			
	911 521 605 00 5ZG	Beige/ Beige/brown			
1	911 521 605 00	Seat cushion Leatherette/ Centre part Uni-coloured cloth	80	2	
	911 521 605 00 7ZN	Black/black			
	911 521 605 00 4ZK	Brown/brown			
	911 521 605 00 3ZC	Dark blue/blue			
	911 521 605 00 5ZF	Beige/Beige			

Model: 911 78 Model life 1978>>1983

Pos	Part Number	Description	Remark	Qty	Model
1	911 521 605 01	Seat cushion Leatherette/ Centre part Braided texture		2	
	911 521 605 01 8AT	Lobster	-78		
	911 521 605 01 5AT	Cork			
	911 521 605 01 7AT	Black			
	911 521 605 01 4AT	Brown	79-		
	911 521 605 01 50B	Beige			
1	911 521 605 02	Seat cushion Leather		2	
	911 521 605 02 8BB	Lobster	-78		
	911 521 605 02 5BB	Cork	-79		
	911 521 605 02 7BA	Black	-79		
	911 521 605 02 20B	Dark green			
	911 521 605 02 2BF	Light green	-78		
	911 521 605 02 40A	Brown			
	911 521 605 02 3BA	Blue	-79		
	911 521 605 02 8BM	Light red	-79		
	911 521 605 02 1BA	Yellow	-79		
	911 521 605 02 9BA	White	-79		
	911 521 605 02 70A	Black	80		
	911 521 605 02 30B	Dark blue	80		
	911 521 605 02 50B	Beige	80		
	911 521 605 02 40D	Cork	80		
	911 521 605 02 30A	Blue	80		
	911 521 605 02 80B	Light red	80		
	911 521 605 02 10A	Yellow	80		
	911 521 605 02 99A	White	80		
2	911 521 621 00	Seat frame		2	
3	911 521 697 00	Foam part Seat cushion		2	
4	911 521 683 00	Foam part Seat side bolster	/L	1	
(4)	911 521 684 00	Foam part Seat side bolster	/R	1	
5	911 521 197 02	Cover for cushion Pin stripe velour		2	
	911 521 197 02 8AK	Lobster			
	911 521 197 02 5AK	Cork			
	911 521 197 02 7AK	Black			
5	911 521 197 02	Cover for cushion Tartan cloth		2	
	911 521 197 02 8AB	Red/blue/black			
	911 521 197 02 2AC	Green/blue/black			
	911 521 197 02 4AD	Brown/white/beige			
5	911 521 197 02	Cover for cushion Checker board velour		2	
	911 521 197 02 37A	Blue/black			
	911 521 197 02 47A	Brown/black			
	911 521 197 02 67A	Grey/black			
	911 521 197 02 54A	Beige/brown			
5	911 521 197 02	Cover for cushion Uni-coloured cloth		2	
	911 521 197 02 30C	Blue			
	911 521 197 02 40C	Brown/brown			
	911 521 197 02 50C	Beige			
	911 521 197 02 70F	Black			
5	911 521 197 03	Cover for cushion Leatherette Braided texture		2	
	911 521 197 03 8AT	Lobster	-78		
	911 521 197 03 5AT	Cork			

Model: 911 78 Model life 1978>>1983

Pos	Part Number	Description	Remark	Qty	Model
5	911 521 197 03 7AT	Black		2	
	911 521 197 03 4AT	Brown	79-		
	911 521 197 03 50B	Beige			
	911 521 197 04	Cover for cushion Leather			
	911 521 197 04 8BB	Lobster	-78		
	911 521 197 04 5BB	Cork	-79		
	911 521 197 04 7BA	Black	-79		
	911 521 197 04 20B	Dark green			
	911 521 197 04 2BF	Light green	-78		
	911 521 197 04 40A	Brown			
	911 521 197 04 3BA	Blue	-79		
	911 521 197 04 8BM	Light red	-79		
	911 521 197 04 1BA	Yellow	-79		
	911 521 197 04 9BA	White	-79		
	911 521 197 04 70A	Black	80		
	911 521 197 04 30B	Dark blue	80		
	911 521 197 04 50B	Beige	80		
	911 521 197 04 40D	Cork	80		
	911 521 197 04 30A	Blue	80		
	6	911 521 197 04 80B	Light red		
911 521 197 04 10A		Yellow	80		
911 521 197 04 99A		White	80		
911 521 073 02		Seat side bolster cover Leatherette	/L	1	
911 521 073 02 8AS		Lobster	-78		
911 521 073 02 5AS		Cork			
911 521 073 02 7AS		Black			
911 521 073 02 40A		Brown	79-		
911 521 073 02 50B		Beige			
(6)		911 521 074 02	Seat side bolster cover Leatherette	/R	1
6	911 521 074 02 8AS	Lobster	-78		
	911 521 074 02 5AS	Cork			
	911 521 074 02 7AS	Black			
	911 521 074 02 40A	Brown	79-		
	911 521 074 02 50B	Beige			
	911 521 073 03	Seat side bolster cover Leather	/L	1	
	911 521 073 03 8AH	Lobster	-78		
	911 521 073 03 5AH	Cork	-79		
	911 521 073 03 7AG	Black	-79		
	911 521 073 03 20B	Dark green			
(6)	911 521 073 03 2AP	Light green	-78		
	911 521 073 03 40A	Brown			
	911 521 073 03 3AG	Blue	-79		
	911 521 073 03 8AT	Light red	-79		
	911 521 073 03 1AG	Yellow	-79		
	911 521 073 03 9AG	White	-79		
	911 521 073 03 70A	Black	80		
	911 521 073 03 30B	Dark blue	80		
	911 521 073 03 50B	Beige	80		
	911 521 073 03 40D	Cork	80		
(6)	911 521 073 03 30A	Blue	80		
	911 521 073 03 80B	Light red	80		
	911 521 073 03 10A	Yellow	80		
	911 521 073 03 99A	White	80		
	911 521 074 03	Seat side bolster cover Leather	/R	1	
	911 521 074 03 8AH	Lobster	-78		
911 521 074 03 5AH	Cork	-79			
911 521 074 03 7AG	Black	-79			
911 521 074 03 20B	Dark green				

Model: 911 78

Model life 1978>>1983

Pos	Part Number	Description	Remark	Qty	Model
	911 521 074 03 2AP	Light green	-78		
	911 521 074 03 40A	Brown			
	911 521 074 03 3AG	Blue	-79		
	911 521 074 03 8AT	Light red	-79		
	911 521 074 03 1AG	Yellow	-79		
	911 521 074 03 9AG	White	-79		
	911 521 074 03 70A	Black	80		
	911 521 074 03 30B	Dark blue	80		
	911 521 074 03 50B	Beige	80		
	911 521 074 03 40D	Cork	80		
	911 521 074 03 30A	Blue	80		
	911 521 074 03 80B	Light red	80		
	911 521 074 03 10A	Yellow	80		
	911 521 074 03 99A	White	80		
7	911 521 685 00	Belt		8	
8	911 521 691 00	Belt hook		16	
9	901 521 191 00	Rubber support	/L	1	
(9)	901 521 192 00	Rubber support	/R	1	

Model: 911 78

Model life 1978>>1983

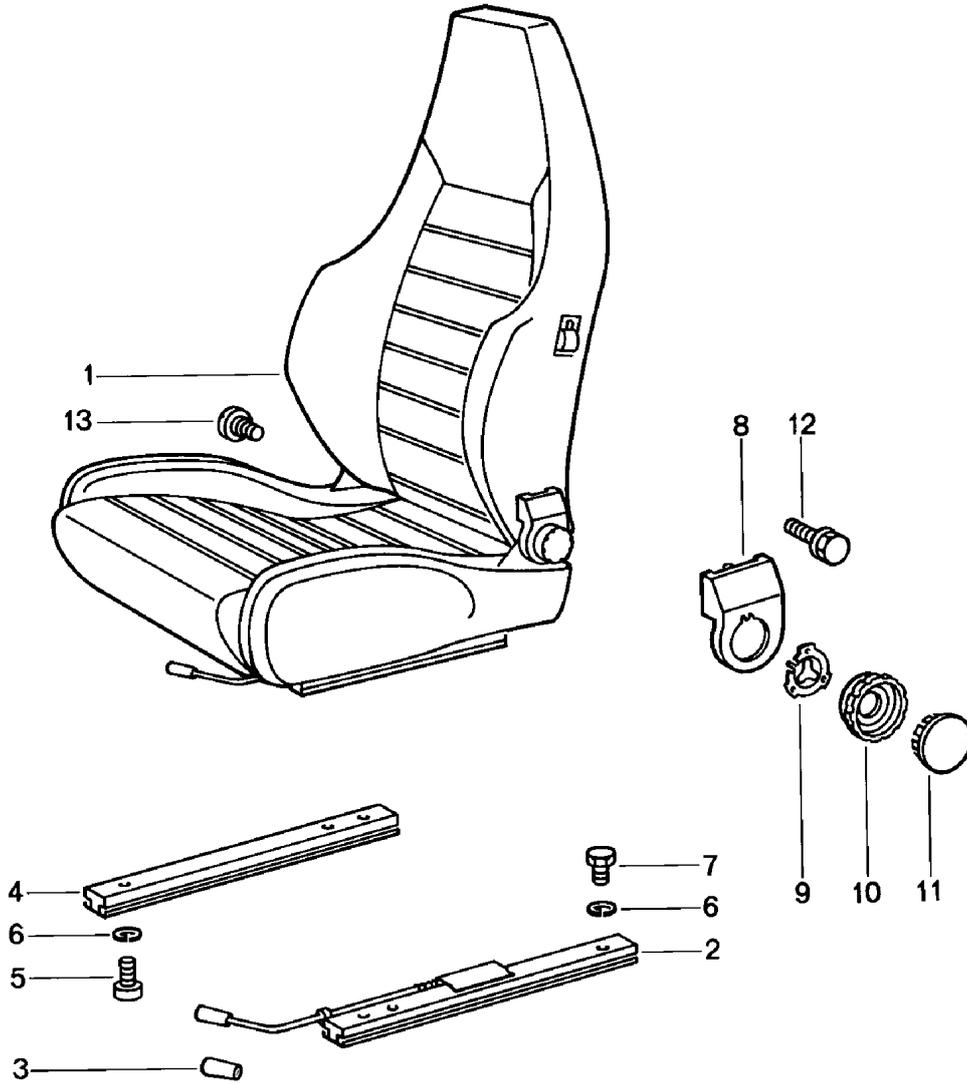

Model: 911 78 Model life 1978>>1983

Pos	Part Number	Description	Remark	Qty	Model
		Sports seat	81-		
		Complete			
1	911 521 007 61	Sports seat	/L	1	
		Leather			
	911 521 007 61 1AJ	Black	-82		
	911 521 007 61 3NG	Brown	-82		
	911 521 007 61 30B	Dark blue	-82		
	911 521 007 61 50B	Beige			
	911 521 007 61 80S	Can-can-red			
	911 521 007 61 95S	Papyrus			
	911 521 007 61 60S	Hannibal grey			
	911 521 007 61 20S	Mint green			
	911 521 007 61 LG7	Burgundy	83-		
	911 521 007 61 KZ4	Grey-beige	83-		
	911 521 007 61 KZ2	Black	83-		
	911 521 007 61 KZ3	Blue	83-		
	911 521 007 61 KZ5	Brown	83-		
(1)	911 521 008 61	Sports seat	/R	1	
		Leather			
	911 521 008 61 1AJ	Black	-82		
	911 521 008 61 3NG	Brown	-82		
	911 521 008 61 30B	Dark blue	-82		
	911 521 008 61 50B	Beige			
	911 521 008 61 80S	Can-can-red			
	911 521 008 61 95S	Papyrus			
	911 521 008 61 60S	Hannibal grey			
	911 521 008 61 20S	Mint green			
	911 521 008 61 LG7	Burgundy	83-		
	911 521 008 61 KZ4	Grey-beige	83-		
	911 521 008 61 KZ2	Black	83-		
	911 521 008 61 KZ3	Blue	83-		
	911 521 008 61 KZ5	Brown	83-		
1	911 521 007 61	Sports seat	/L	1	
		Leather/ Piping			
	911 521 007 61 6AD	Russet			
		Doric grey			
(1)	911 521 008 61	Sports seat	/R	1	
		Leather/ Piping			
	911 521 008 61 6AD	Russet			
		Doric grey			
1	911 521 007 07	Sports seat	/L	1	
		Leatherette/ Seat and backrest surface			
		Berber cloth			
	911 521 007 07 GE9	Black/ Grey/black	-82 -82		
	911 521 007 07 BD7	Blue/ Blue/black	-82 -82		
	911 521 007 07 FE3	Brown/ Beige/brown	-82 -82		
	911 521 007 07 BD9	Beige/ Beige/brown	-82 -82		
	911 521 007 07 LK8	Burgundy/ Burgundy-grey	83- 83-		
	911 521 007 07 JM9	Grey-beige/ Grey-beige-grey	83- 83-		
	911 521 007 07 JM3	Black/ Grey/black	83- 83-		
	911 521 007 07 JM8	Blue/ Blue/black	83- 83-		
	911 521 007 07 JM4	Brown/ Brown/	83- 83-		

Model: 911 78

Model life 1978>>1983

Pos	Part Number	Description	Remark	Qty	Model
(1)	911 521 008 07	Beige/brown Sports seat Leatherette/ Seat and backrest surface Berber cloth	83- /R	1	
	911 521 008 07 GE9	Black/ Grey/black	-82 -82		
	911 521 008 07 BD7	Blue/ Blue/black	-82 -82		
	911 521 008 07 FE3	Brown/ Beige/brown	-82 -82		
	911 521 008 07 BD9	Beige/ Beige/brown			
	911 521 008 07 LK8	Burgundy/ Burgundy-grey	83- 83-		
	911 521 008 07 JM9	Grey-beige/ Grey-beige-grey	83- 83-		
	911 521 008 07 JM3	Black/ Grey/black	83- 83-		
	911 521 008 07 JM8	Blue/ Blue/black	83- 83-		
	911 521 008 07 JM4	Brown/ Beige/brown	83- 83-		
2	928 521 489 02	Seat rail with locking device	/L	1	
(2)	928 521 490 02	Seat rail with locking device	/R	1	
(3)	911 521 533 01	Handle for longitudinal adjustment		2	
	911 521 533 01 01C	Satin black			
4	944 521 491 00	Seat rail without locking device See TPI GR.8 NR.34		2	
4		Seat rail		2	
5	N 014 761 2	Pan-head screw M 6 X 12		8	
5	900 119 129 01	Pan-head screw M 6 X 12		8	
6	N 012 006 4	Lock ring B 6		16	
7	900 075 057 02	Hexagon-head bolt M 6 X 16		8	
7	900 075 057 03	Hexagon-head bolt M 6 X 16		8	
8	911 521 359 02	Cover	/L	1	
(8)	911 521 360 02	Cover	/R	1	
9	911 521 571 00	Tensioning spring		2	
(10)	911 521 381 02	Cover for backrest adjustment Comprising: POS. 10 Shifting wheel POS. 11 Cover		2	
10	911 521 381 00	Shifting wheel		2	
10	911 521 381 02	Cover		2	
11	911 521 383 00	Cover		2	
11	911 521 381 02	Cover		2	
12	911 521 371 00	Screw Inner		2	
13	911 521 547 00	Screw M 10 X 20		4	

Model: 911 78

Model life 1978>>1983

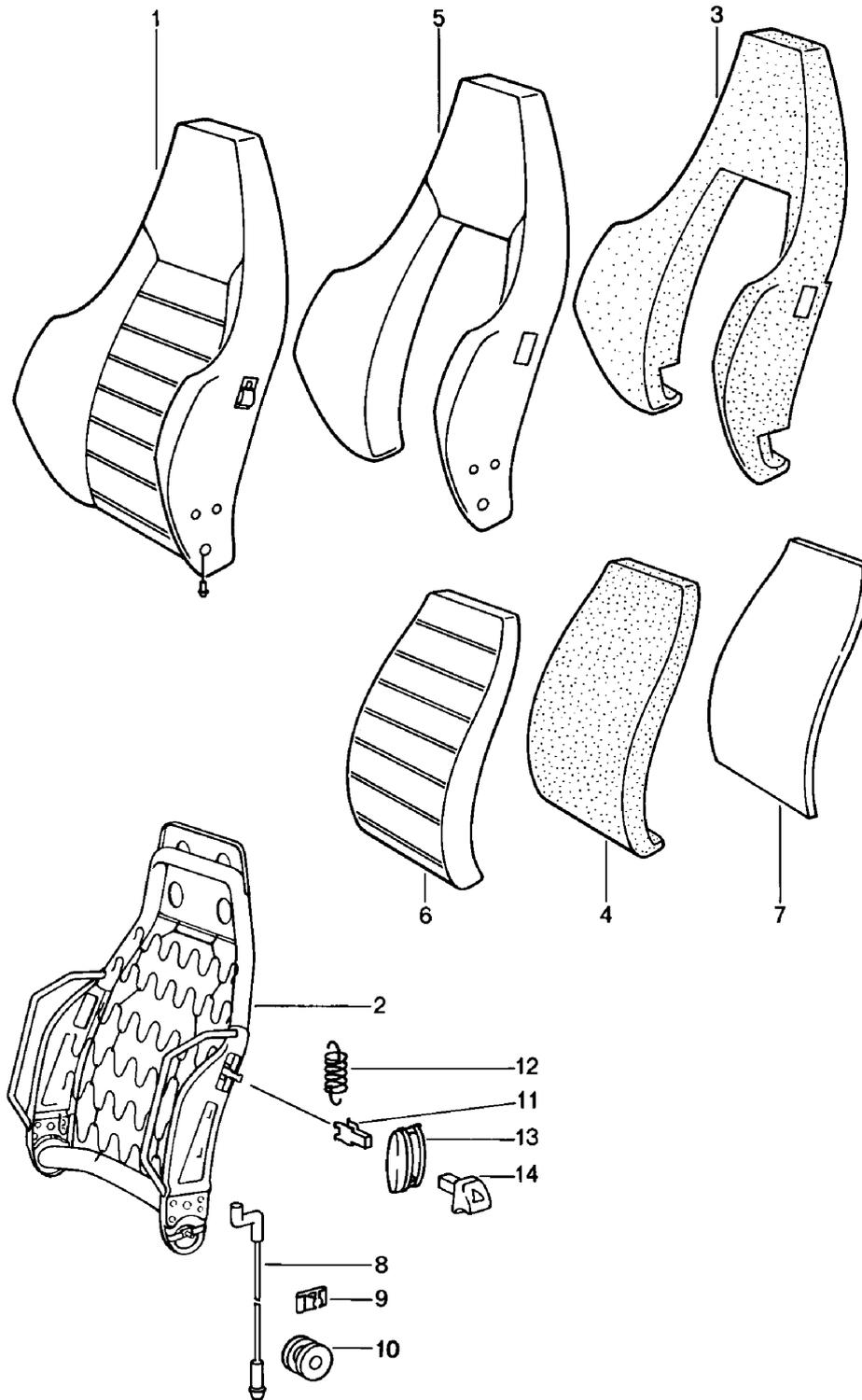

Model: 911 78 Model life 1978>>1983

Pos	Part Number	Description	Remark	Qty	Model
1	911 521 603 50	Sports seat Backrest Single parts Backrest Leather	81- /L	1	
	911 521 603 50 1AJ	Black	-82		
	911 521 603 50 3NG	Brown	-82		
	911 521 603 50 30B	Dark blue	-82		
	911 521 603 50 50B	Beige			
	911 521 603 50 80S	Can-can-red			
	911 521 603 50 95S	Papyrus			
	911 521 603 50 60S	Hannibal grey			
	911 521 603 50 20S	Mint green			
	911 521 603 50 LG7	Burgundy	83-		
	911 521 603 50 KZ4	Grey-beige	83-		
	911 521 603 50 KZ2	Black	83-		
	911 521 603 50 KZ3	Blue	83-		
	911 521 603 50 KZ5	Brown	83-		
(1)	911 521 604 50	Backrest Leather	/R	1	
	911 521 604 50 1AJ	Black	-82		
	911 521 604 50 3NG	Brown	-82		
	911 521 604 50 30B	Dark blue	-82		
	911 521 604 50 50B	Beige			
	911 521 604 50 80S	Can-can-red			
	911 521 604 50 95S	Papyrus			
	911 521 604 50 60S	Hannibal grey			
	911 521 604 50 20S	Mint green			
	911 521 604 50 LG7	Burgundy	83-		
	911 521 604 50 KZ4	Grey-beige	83-		
	911 521 604 50 KZ2	Black	83-		
	911 521 604 50 KZ3	Blue	83-		
	911 521 604 50 KZ5	Brown	83-		
1	911 521 603 50	Backrest Leather/ Piping	/L	1	
	911 521 603 50 6AD	Russet Doric grey			
(1)	911 521 604 50	Backrest Leather/ Piping	/R	1	
	911 521 604 50 6AD	Russet Doric grey			
(1)	911 521 603 06	Backrest Leatherette/ Backrest surface Berber cloth	/L	1	
	911 521 603 06 GE9	Black/ Grey/black	-82		
	911 521 603 06 BD7	Blue/ Blue/black	-82		
	911 521 603 06 FE3	Brown/ Beige/brown	-82		
	911 521 603 06 BD9	Beige/ Beige/brown			
	911 521 603 06 LK8	Burgundy/ Burgundy-grey	83-		
	911 521 603 06 JM9	Grey-beige/ Grey-beige-grey	83-		
	911 521 603 06 JM3	Black/ Grey/black	83-		
	911 521 603 06 JM8	Blue/ Blue/black	83-		

Model: 911 78 Model life 1978>>1983

Pos	Part Number	Description	Remark	Qty	Model
	911 521 603 06 JM4	Brown/ Beige/brown	83-		
(1)	911 521 604 06	Backrest Leatherette/ Backrest surface Berber cloth	/R	1	
	911 521 604 06 GE9	Black/ Grey/black	-82		
	911 521 604 06 BD7	Blue/ Blue/black	-82		
	911 521 604 06 FE3	Brown/ Beige/brown	-82		
	911 521 604 06 BD9	Beige/ Beige/brown			
	911 521 604 06 LK8	Burgundy/ Burgundy-grey	83-		
	911 521 604 06 JM9	Grey-beige/ Grey-beige-grey	83-		
	911 521 604 06 JM3	Black/ Grey/black	83-		
	911 521 604 06 JM8	Blue/ Blue/black	83-		
	911 521 604 06 JM4	Brown/ Beige/brown	83-		
2	911 521 613 02	Backrest frame	/L	1	
(2)	911 521 614 02	Backrest frame	/R	1	
3	911 521 751 02	Foam part Backrest side bolster		2	
4	911 521 104 02	Foam part Backrest cushion		2	
5	911 521 072 70	Backrest side bolster cover Leather		2	
	911 521 072 70 1AJ	Black	-82		
	911 521 072 70 3NG	Brown	-82		
	911 521 072 70 30B	Dark blue	-82		
	911 521 072 70 50B	Beige			
	911 521 072 70 80S	Can-can-red			
	911 521 072 70 95S	Papyrus			
	911 521 072 70 60S	Hannibal grey			
	911 521 072 70 20S	Mint green			
	911 521 072 70 LG7	Burgundy	83-		
	911 521 072 70 KZ4	Grey-beige	83-		
	911 521 072 70 KZ2	Black	83-		
	911 521 072 70 KZ3	Blue	83-		
	911 521 072 70 KZ5	Brown	83		
5	911 521 072 70	Backrest side bolster cover Leather/ Piping		2	
	911 521 072 70 6AD	Russet Doric grey			
5	911 521 072 06	Backrest side bolster cover Leatherette/ Backrest surface Berber cloth		2	
	911 521 072 06 GE9	Black/ Grey/black	-82		
	911 521 072 06 BD7	Blue/ Blue/black	-82		
	911 521 072 06 FE3	Brown/ Beige/brown	-82		
	911 521 072 06 BD9	Beige/ Beige/brown			
	911 521 072 06 LK8	Burgundy/ Burgundy-grey	83-		

Model: 911 78 Model life 1978>>1983

Pos	Part Number	Description	Remark	Qty	Model
	911 521 072 06 JM9	Burgundy-grey Grey-beige/grey-beige	83-		
	911 521 072 06 JM3	Grey-beige-grey Black/ Grey/black	83-		
	911 521 072 06 JM8	Blue/ Blue/black	83-		
	911 521 072 06 JM4	Brown/ Beige/brown	83-		
6	911 521 403 50	Backrest cushion cover Leather		2	
	911 521 403 50 1AJ	Black	-82		
	911 521 403 50 3NG	Brown	-82		
	911 521 403 50 30B	Dark blue	-82		
	911 521 403 50 50B	Beige			
	911 521 403 50 80S	Can-can-red			
	911 521 403 50 95S	Papyrus			
	911 521 403 50 60S	Hannibal grey			
	911 521 403 50 20S	Mint green			
	911 521 403 50 LG7	Burgundy	83-		
	911 521 403 50 KZ4	Grey-beige	83-		
	911 521 403 50 KZ2	Black	83-		
	911 521 403 50 KZ3	Blue	83-		
	911 521 403 50 KZ5	Brown	83		
6	911 521 403 50	Backrest cushion cover Leather/ Piping		2	
	911 521 403 50 6AD	Russet Doric grey			
6	911 521 403 06	Backrest cushion cover Berber cloth		2	
	911 521 403 06 1GB	Grey/black			
	911 521 403 06 37B	Blue/black			
	911 521 403 06 8NB	Beige/brown			
	911 521 403 06 6LB	Burgundy-grey	83-		
	911 521 403 06 1FB	Grey-beige-grey	83-		
7	911 521 575 00	Filler piece		2	
8	911 521 361 00	Wire pull		2	
8	911 521 361 02	Wire pull		2	
9	911 521 369 00	Terminal		2	
10	911 521 343 00	Guide bush		2	
11	311 881 247	Clip		1	
12	311 881 287 A	Tension spring		2	
13	911 521 815 00	Rosette		2	
	911 521 815 00 01C	Satin black			
14	911 521 817 00	Control button		2	
	911 521 817 00 01C	Satin black			

Model: 911 78

Model life 1978>>1983

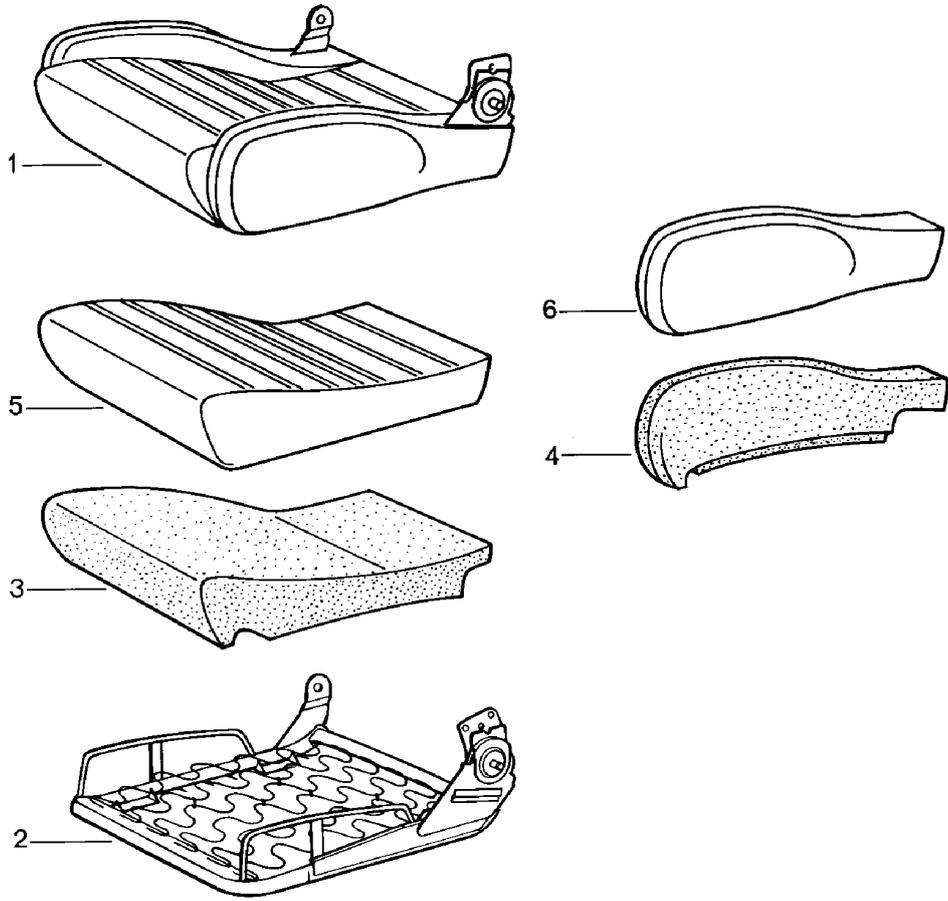

Model: 911 78 Model life 1978>>1983

Pos	Part Number	Description	Remark	Qty	Model
1	911 521 605 50	Sports seat Seat cushion Single parts Seat cushion Leather	81- /L	1	
	911 521 605 50 1AJ	Black	-82		
	911 521 605 50 3NG	Brown	-82		
	911 521 605 50 30B	Dark blue	-82		
	911 521 605 50 50B	Beige			
	911 521 605 50 80S	Can-can-red			
	911 521 605 50 95S	Papyrus			
	911 521 605 50 60S	Hannibal grey			
	911 521 605 50 20S	Mint green			
	911 521 605 50 LG7	Burgundy	83-		
	911 521 605 50 KZ4	Grey-beige	83-		
	911 521 605 50 KZ2	Black	83-		
	911 521 605 50 KZ3	Blue	83-		
	911 521 605 50 KZ5	Brown	83-		
(1)	911 521 606 50	Seat cushion Leather	/R	1	
	911 521 606 50 1AJ	Black	-82		
	911 521 606 50 3NG	Brown	-82		
	911 521 606 50 30B	Dark blue	-82		
	911 521 606 50 50B	Beige			
	911 521 606 50 80S	Can-can-red			
	911 521 606 50 95S	Papyrus			
	911 521 606 50 60S	Hannibal grey			
	911 521 606 50 20S	Mint green			
	911 521 606 50 LG7	Burgundy	83-		
	911 521 606 50 KZ4	Grey-beige	83-		
	911 521 606 50 KZ2	Black	83-		
	911 521 606 50 KZ3	Blue	83-		
	911 521 606 50 KZ5	Brown	83-		
1	911 521 605 50	Seat cushion Leather/ Piping	/L	1	
	911 521 605 50 6AD	Doric grey Doric grey			
(1)	911 521 606 50	Seat cushion Leather/ Piping	/R	1	
	911 521 606 50 6AD	Doric grey Doric grey			
(1)	911 521 605 06	Seat cushion Leatherette/ Seat surface Berber cloth	/L	1	
	911 521 605 06 GE9	Black/ Grey/black	-82		
	911 521 605 06 BD7	Blue/ Blue/black	-82		
	911 521 605 06 FE3	Brown/ Beige/brown	-82		
	911 521 605 06 BD9	Beige/ Beige/brown			
	911 521 605 06 LK8	Burgundy/ Burgundy-grey	83-		
	911 521 605 06 JM9	Grey-beige/ Grey-beige-grey	83-		
	911 521 605 06 JM3	Black/ Grey/black	83-		
	911 521 605 06 JM8	Blue/ Blue/black	83-		

Model: 911 78 Model life 1978>>1983

Pos	Part Number	Description	Remark	Qty	Model
	911 521 605 06 JM4	Brown/ Beige/brown	83-		
(1)	911 521 606 06	Seat cushion Leatherette/ Seat surface Berber cloth	/R	1	
	911 521 606 06 GE9	Black/ Grey/black	-82		
	911 521 606 06 BD7	Blue/ Blue/black	-82		
	911 521 606 06 FE3	Brown/ Beige/brown	-82		
	911 521 606 06 BD9	Beige/ Beige/brown			
	911 521 606 06 LK8	Burgundy/ Burgundy-grey	83-		
	911 521 606 06 JM9	Grey-beige/ Grey-beige-grey	83-		
	911 521 606 06 JM3	Black/ Grey/black	83-		
	911 521 606 06 JM8	Blue/ Blue/black	83-		
	911 521 606 06 JM4	Brown/ Beige/brown	83-		
2	911 521 621 01	Seat frame	/L	1	
(2)	911 521 622 01	Seat frame	/R	1	
3	911 521 697 02	Foam part Seat cushion		2	
4	911 521 683 02	Foam part Seat side bolster Left seat	/L	1	
(4)	911 521 654 02	Foam part Seat side bolster Left seat	/R	1	
(4)	911 521 653 02	Foam part Seat side bolster Right seat	/L	1	
(4)	911 521 684 02	Foam part Seat side bolster Right seat	/R	1	
5	911 521 439 50	Cover for cushion Leather		2	
	911 521 439 50 1AJ	Black	-82		
	911 521 439 50 3NG	Brown	-82		
	911 521 439 50 30B	Dark blue	-82		
	911 521 439 50 50B	Beige			
	911 521 439 50 80S	Can-can-red			
	911 521 439 50 95S	Papyrus			
	911 521 439 50 60S	Hannibal grey			
	911 521 439 50 20S	Mint green			
	911 521 439 50 LG7	Burgundy	83-		
	911 521 439 50 KZ4	Grey-beige	83-		
	911 521 439 50 KZ2	Black	83-		
	911 521 439 50 KZ3	Blue	83-		
	911 521 439 50 KZ5	Brown	83-		
5	911 521 439 50	Cover for cushion Leather/ Piping		2	
	911 521 439 50 6AD	Russet			
5	911 521 439 06	Doric grey Cover for cushion Leatherette/ Seat surface		2	

Model: 911 78 Model life 1978>>1983

Pos	Part Number	Description	Remark	Qty	Model
		Berber cloth			
	911 521 439 06 1GB	Grey/black			
	911 521 439 06 37B	Blue/black			
	911 521 439 06 8NB	Beige/brown			
	911 521 439 06 6LB	Burgundy-grey	83-		
	911 521 439 06 1FB	Grey-beige-grey	83-		
6	911 521 631 50	Seat side bolster cover	/L	1	
		Left seat			
		Leather			
	911 521 631 50 1AJ	Black	-82		
	911 521 631 50 3NG	Brown	-82		
	911 521 631 50 30B	Dark blue	-82		
	911 521 631 50 50B	Beige			
	911 521 631 50 95S	Papyrus			
	911 521 631 50 80S	Can-can-red			
	911 521 631 50 60S	Hannibal grey			
	911 521 631 50 20S	Mint green			
	911 521 631 50 LG7	Burgundy	83-		
	911 521 631 50 KZ4	Grey-beige	83-		
	911 521 631 50 KZ2	Black	83-		
	911 521 631 50 KZ3	Blue	83-		
	911 521 631 50 KZ5	Brown	83		
(6)	911 521 632 50	Seat side bolster cover	/R	1	
		Left seat			
		Leather			
	911 521 632 50 1AJ	Black	-82		
	911 521 632 50 3NG	Brown	-82		
	911 521 632 50 30B	Dark blue	-82		
	911 521 632 50 50B	Beige			
	911 521 632 50 95S	Papyrus			
	911 521 632 50 80S	Can-can-red			
	911 521 632 50 60S	Hannibal grey			
	911 521 632 50 20S	Mint green			
	911 521 632 50 LG7	Burgundy	83-		
	911 521 632 50 KZ4	Grey-beige	83-		
	911 521 632 50 KZ2	Black	83-		
	911 521 632 50 KZ3	Blue	83-		
	911 521 632 50 KZ5	Brown	83		
(6)	911 521 633 50	Seat side bolster cover	/L	1	
		Right seat			
		Leather			
	911 521 633 50 1AJ	Black	-82		
	911 521 633 50 3NG	Brown	-82		
	911 521 633 50 30B	Dark blue	-82		
	911 521 633 50 50B	Beige			
	911 521 633 50 95S	Papyrus			
	911 521 633 50 80S	Can-can-red			
	911 521 633 50 60S	Hannibal grey			
	911 521 633 50 20S	Mint green			
	911 521 633 50 LG7	Burgundy	83-		
	911 521 633 50 KZ4	Grey-beige	83-		
	911 521 633 50 KZ2	Black	83-		
	911 521 633 50 KZ3	Blue	83-		
	911 521 633 50 KZ5	Brown	83		
(6)	911 521 634 50	Seat side bolster cover	/R	1	
		Right seat			
		Leather			
	911 521 634 50 1AJ	Black	-82		
	911 521 634 50 3NG	Brown	-82		
	911 521 634 50 30B	Dark blue	-82		
	911 521 634 50 50B	Beige			
	911 521 634 50 95S	Papyrus			
	911 521 634 50 80S	Can-can-red			

Model: 911 78 Model life 1978>>1983

Pos	Part Number	Description	Remark	Qty	Model
	911 521 634 50 60S	Hannibal grey			
	911 521 634 50 20S	Mint green			
	911 521 634 50 LG7	Burgundy	83-		
	911 521 634 50 KZ4	Grey-beige	83-		
	911 521 634 50 KZ2	Black	83-		
	911 521 634 50 KZ3	Blue	83-		
	911 521 634 50 KZ5	Brown	83		
6	911 521 631 50	Seat side bolster cover Left seat Leather/ Piping	/L	1	
	911 521 631 50 6AD	Russet			
(6)	911 521 632 50	Doric grey Seat side bolster cover Left seat Leather/ Piping	/R	1	
	911 521 632 50 6AD	Russet			
(6)	911 521 633 50	Doric grey Seat side bolster cover Right seat Leather/ Piping	/L	1	
	911 521 633 50 6AD	Russet			
(6)	911 521 634 50	Doric grey Seat side bolster cover Right seat Leather/ Piping	/R	1	
	911 521 634 50 6AD	Russet			
(6)	911 521 631 06	Doric grey Seat side bolster cover Left seat Leatherette/ Seat surface Berber cloth	/L	1	
	911 521 631 06 JM3	Black/ Grey/black	-82		
	911 521 631 06 BD9	Beige/ Beige/brown			
	911 521 631 06 LK8	Burgundy/ Burgundy-grey	83-		
	911 521 631 06 JM9	Grey-beige/ Grey-beige-grey	83-		
	911 521 631 06 JM3	Black/ Grey/black			
	911 521 631 06 JM8	Blue/ Blue/black			
	911 521 631 06 JM4	Brown/ Beige/brown			
(6)	911 521 632 06	Seat side bolster cover Left seat Leatherette/ Seat surface Berber cloth	/R	1	
	911 521 632 06 JM3	Black/ Grey/black	-82		
	911 521 632 06 BD9	Beige/ Beige/brown			
	911 521 632 06 LK8	Burgundy/ Burgundy-grey	83-		
	911 521 632 06 JM9	Grey-beige/ Grey-beige-grey	83-		

Model: 911 78 Model life 1978>>1983

Pos	Part Number	Description	Remark	Qty	Model
	911 521 632 06 JM3	Black/ Grey/black			
	911 521 632 06 JM8	Blue/ Blue/black			
	911 521 632 06 JM4	Brown/ Beige/brown			
(6)	911 521 633 06	Seat side bolster cover Right seat Leatherette/ Seat surface Berber cloth	/L	1	
	911 521 633 06 JM3	Black/ Grey/black	-82		
	911 521 633 06 BD9	Beige/ Beige/brown			
	911 521 633 06 LK8	Burgundy/ Burgundy-grey	83-		
	911 521 633 06 JM9	Grey-beige/ Grey-beige-grey	83-		
	911 521 633 06 JM3	Black/ Grey/black			
	911 521 633 06 JM8	Blue/ Blue/black			
	911 521 633 06 JM4	Brown/ Beige/brown			
(6)	911 521 634 06	Seat side bolster cover Right seat Leatherette/ Seat surface Berber cloth	/R	1	
	911 521 634 06 JM3	Black/ Grey/black	-82		
	911 521 634 06 BD9	Beige/ Beige/brown			
	911 521 634 06 LK8	Burgundy/ Burgundy-grey	83-		
	911 521 634 06 JM9	Grey-beige/ Grey-beige-grey	83-		
	911 521 634 06 JM3	Black/ Grey/black			
	911 521 634 06 JM8	Blue/ Blue/black			
	911 521 634 06 JM4	Brown/ Beige/brown			

Model: 911 78

Model life 1978>>1983

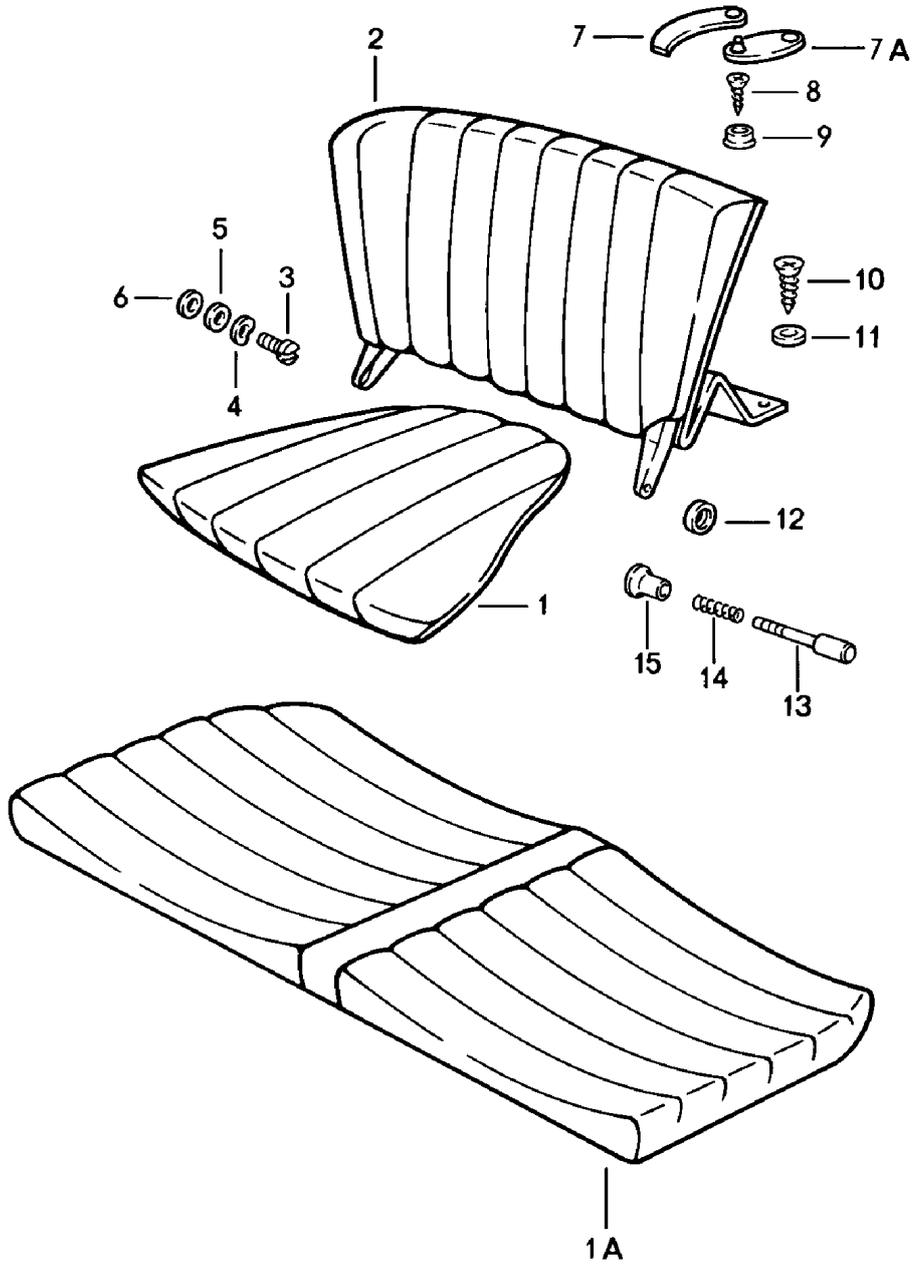

Model: 911 78 Model life 1978>>1983

Pos	Part Number	Description	Remark	Qty	Model
		Back seat cushion Back seat backrest Back seat backrest See group 8/07/07	83		COUPE/TARGA CABRIO
1	911 522 051 06	Back seat cushion Leatherette	/L	1	SC
	911 522 051 06 3MK	Burgundy	83-		
	911 522 051 06 4FK	Grey-beige	83-		
	911 522 051 06 43S	Black	83-		
	911 522 051 06 1HH	Blue	83-		
	911 522 051 06 4RB	Brown	83-		
(1)	911 522 052 06	Back seat cushion Leatherette	/R	1	SC
	911 522 052 06 3MK	Burgundy	83-		
	911 522 052 06 4FK	Grey-beige	83-		
	911 522 052 06 43S	Black	83-		
	911 522 052 06 1HH	Blue	83-		
	911 522 052 06 4RB	Brown	83-		
1	930 522 051 74	Back seat cushion Leather	/L	1	
	930 522 051 74 3NG	Brown			
	930 522 051 74 1AJ	Black	80-		
	930 522 051 74 30B	Dark blue	80-		
	930 522 051 74 50B	Beige	80-		
	930 522 051 74 95S	Papyrus	81-		
	930 522 051 74 60S	Hannibal grey	81-		
	930 522 051 74 20S	Mint green	81-		
	930 522 051 74 LG7	Burgundy	83-		
	930 522 051 74 KZ4	Grey-beige	83-		
	930 522 051 74 KZ6	Can-can-red	83-		
	930 522 051 74 LG4	Pearl white	83-		
	930 522 051 74 LG5	Champagne	83-		
	930 522 051 74 LG6	Dark green	83-		
(1)	930 522 052 74	Back seat cushion Leather	/R	1	
	930 522 052 74 3NG	Brown			
	930 522 052 74 1AJ	Black	80-		
	930 522 052 74 30B	Dark blue	80-		
	930 522 052 74 50B	Beige	80-		
	930 522 052 74 95S	Papyrus	81-		
	930 522 052 74 60S	Hannibal grey	81-		
	930 522 052 74 20S	Mint green	81-		
	930 522 052 74 LG7	Burgundy	83-		
	930 522 052 74 KZ4	Grey-beige	83-		
	930 522 052 74 KZ6	Can-can-red	83-		
	930 522 052 74 LG4	Pearl white	83-		
	930 522 052 74 LG5	Champagne	83-		
	930 522 052 74 LG6	Dark green	83-		
1	930 522 051 74	Back seat cushion Leather/ Piping	/L	1	
	930 522 051 74 6AD	Russet Doric grey			
(1)	930 522 052 74	Back seat cushion Leather/ Piping	/R	1	
	930 522 052 74 6AD	Russet Doric grey			
1	930 522 051 01	Back seat cushion Pin stripe velour	/L	1	
	930 522 051 01 8AK	Lobster			
	930 522 051 01 5AK	Cork			

Model: 911 78 Model life 1978>>1983

Pos	Part Number	Description	Remark	Qty	Model
(1)	930 522 051 01 7AK	Black			
	930 522 052 01	Back seat cushion	/R	1	
		Pin stripe velour			
	930 522 052 01 8AK	Lobster			
	930 522 052 01 5AK	Cork			
	930 522 052 01 7AK	Black			
1	930 522 051 01	Back seat cushion	/L	1	
		Tartan cloth			
	930 522 051 01 8AB	Red/blue/black			
	930 522 051 01 2AC	Green/blue/black			
	930 522 051 01 4AD	Brown/white/beige			
(1)	930 522 052 01	Back seat cushion	/R	1	
		Tartan cloth			
	930 522 052 01 8AB	Red/blue/black			
	930 522 052 01 2AC	Green/blue/black			
	930 522 052 01 4AD	Brown/white/beige			
1	930 522 051 01	Back seat cushion	/L	1	
		Checker board velour			
	930 522 051 01 37A	Blue/black			
	930 522 051 01 47A	Brown/black			
	930 522 051 01 67A	Grey/black			
	930 522 051 01 54A	Beige/brown			
	930 522 051 01 LD5	Light grey/black	83-		
	930 522 051 01 LJ8	Blue-grey	83-		
	930 522 051 01 LD6	Brown-grey	83-		
	930 522 051 01 LJ9	Burgundy-grey	83-		
(1)	930 522 052 01	Back seat cushion	/R	1	
		Checker board velour			
	930 522 052 01 37A	Blue/black			
	930 522 052 01 47A	Brown/black			
	930 522 052 01 67A	Grey/black			
	930 522 052 01 54A	Beige/brown			
	930 522 052 01 LD5	Light grey/black	83-		
	930 522 052 01 LJ8	Blue-grey	83-		
	930 522 052 01 LD6	Brown-grey	83-		
	930 522 052 01 LJ9	Burgundy-grey	83-		
1	930 522 051 01	Back seat cushion	/L	1	
		Uni-coloured cloth			
	930 522 051 01 40C	Brown			
	930 522 051 01 50C	Beige			
	930 522 051 01 LK3	Brown	83-		
	930 522 051 01 LK5	Burgundy	83-		
	930 522 051 01 LK6	Grey-beige	83-		
	930 522 051 01 JM2	Black	83-		
	930 522 051 01 JM5	Blue	83-		
		Blue/blue	83-		
(1)	930 522 052 01	Back seat cushion	/R	1	
		Uni-coloured cloth			
	930 522 052 01 40C	Brown			
	930 522 052 01 50C	Beige			
	930 522 052 01 LK3	Brown	83-		
	930 522 052 01 LK5	Burgundy	83-		
	930 522 052 01 LK6	Grey-beige	83-		
	930 522 052 01 JM2	Black	83-		
	930 522 052 01 JM5	Blue	83-		
		Blue/blue	83-		
1	930 522 051 01	Back seat cushion	/L	1	
		Berber cloth			
	930 522 051 01 LK8	Burgundy-grey	83-		
	930 522 051 01 JM9	Grey-beige-grey	83-		
	930 522 051 01 JM3	Grey/black	83-		
	930 522 051 01 JM8	Blue/black	83-		
	930 522 051 01 JM4	Beige/brown	83-		

Model: 911 78 Model life 1978>>1983

Pos	Part Number	Description	Remark	Qty	Model
(1)	930 522 052 01	Back seat cushion Berber cloth	/R	1	
	930 522 052 01 LK8	Burgundy-grey	83-		
	930 522 052 01 JM9	Grey-beige-grey	83-		
	930 522 052 01 JM3	Grey/black	83-		
	930 522 052 01 JM8	Blue/black	83-		
	930 522 052 01 JM4	Beige/brown	83-		
1	930 522 051 01	Back seat cushion Stripe design	/L	1	M403
	930 522 051 01 9LA	Grey-burgundy			
(1)	930 522 052 01	Back seat cushion Stripe design	/R	1	M403
	930 522 052 01 9LA	Grey-burgundy			
2	911 522 005 26	Back seat backrest Leatherette/ Carpet Cut pile	/L 79-	1	SC
	911 522 005 26 8AU	Lobster			
	911 522 005 26 7AU	Black	-82		
	911 522 005 26 4AU	Brown	-82		
	911 522 005 26 3AU	Dark blue	-82		
	911 522 005 26 5BC	Beige	80-82		
	911 522 005 26 5AU	Cork			
	911 522 005 26 3MK	Burgundy	83-		
	911 522 005 26 4FK	Grey-beige	83-		
	911 522 005 26 43S	Black	83-		
	911 522 005 26 1HH	Blue	83-		
	911 522 005 26 4RB	Brown	83-		
2	911 522 017 00	Back seat backrest Leatherette/ Carpet Cut pile	/L	1	
	911 522 017 00 8AU	Lobster			
	911 522 017 00 5AU	Cork			
	911 522 017 00 3MK	Burgundy	83-		
	911 522 017 00 4FK	Grey-beige	83-		
	911 522 017 00 43S	Black	83-		
	911 522 017 00 1HH	Blue	83-		
	911 522 017 00 4RB	Brown	83-		
2	911 522 006 26	Back seat backrest Leatherette/ Carpet Cut pile	/R 79-	1	SC
	911 522 006 26 8AU	Lobster			
	911 522 006 26 7AU	Black	-82		
	911 522 006 26 4AU	Brown	-82		
	911 522 006 26 3AU	Dark blue	-82		
	911 522 006 26 5BC	Beige	80-82		
	911 522 006 26 5AU	Cork			
	911 522 006 26 3MK	Burgundy	83-		
	911 522 006 26 4FK	Grey-beige	83-		
	911 522 006 26 43S	Black	83-		
	911 522 006 26 1HH	Blue	83-		
	911 522 006 26 4RB	Brown	83-		
2	911 522 018 00	Back seat backrest Leatherette/ Carpet Cut pile	/R	1	
	911 522 018 00 8AU	Lobster			
	911 522 018 00 5AU	Cork			
	911 522 018 00 3MK	Burgundy	83-		
	911 522 018 00 4FK	Grey-beige	83-		
	911 522 018 00 43S	Black	83-		

Model: 911 78 Model life 1978>>1983

Pos	Part Number	Description	Remark	Qty	Model
(2)	911 522 018 00 1HH	Blue	83-	1	SC
	911 522 018 00 4RB	Brown	83-		
	911 522 005 27	Back seat backrest	/L (AUS) (F) 79-		
		Leatherette/ Carpet Velour pile			
	911 522 005 27 5AU	Cork			
	911 522 005 27 7AU	Black	-82		
	911 522 005 27 4AU	Brown	-82		
	911 522 005 27 3AU	Dark blue	80-82		
	911 522 005 27 5BC	Beige	80-82		
	911 522 005 27 3MK	Burgundy	83-		
911 522 005 27 4FK	Grey-beige	83-			
911 522 005 27 43S	Black	83-			
911 522 005 27 1HH	Blue	83-			
911 522 005 27 4RB	Brown	83-			
(2)	911 522 017 00	Back seat backrest	/L	1	SC
		Leatherette/ Carpet Velour pile			
	911 522 017 00 5AU	Cork			
	911 522 017 00 3MK	Burgundy	83-		
	911 522 017 00 4FK	Grey-beige	83-		
	911 522 017 00 43S	Black	83-		
	911 522 017 00 1HH	Blue	83-		
	911 522 017 00 4RB	Brown	83-		
	911 522 006 27	Back seat backrest	/R (AUS) (F) 79-		
		Leatherette/ Carpet Velour pile			
911 522 006 27 5AU	Cork				
911 522 006 27 7AU	Black	-82			
911 522 006 27 4AU	Brown	-82			
911 522 006 27 3AU	Dark blue	80-82			
911 522 006 27 5BC	Beige	80-82			
911 522 006 27 3MK	Burgundy	83-			
911 522 006 27 4FK	Grey-beige	83-			
911 522 006 27 43S	Black	83-			
911 522 006 27 1HH	Blue	83-			
911 522 006 27 4RB	Brown	83-			
(2)	911 522 018 00	Back seat backrest	/R	1	SC
		Leatherette/ Carpet Velour pile			
	911 522 018 00 5AU	Cork			
	911 522 018 00 3MK	Burgundy	83-		
	911 522 018 00 4FK	Grey-beige	83-		
	911 522 018 00 43S	Black	83-		
	911 522 018 00 1HH	Blue	83-		
	911 522 018 00 4RB	Brown	83-		
	911 522 005 28	Back seat backrest	/L 80-		
		Leatherette/ Centre part Tartan cloth	80		
911 522 005 28 8ZZ	Black/ Red/blue/black				
911 522 005 28 8ZE	Dark blue/ Red/blue/black				
911 522 005 28 2ZZ	Black/ Green/blue/black				
911 522 005 28 2ZE	Dark blue/				

Model: 911 78 Model life 1978>>1983

Pos	Part Number	Description	Remark	Qty	Model
	911 522 005 28 4ZZ	Green/blue/black Black/ Brown/white/beige			
	911 522 005 28 4ZS	Brown/ Brown/white/beige			
	911 522 005 28 4ZH	Beige/ Brown/white/beige			
(2)	911 522 006 28	Back seat backrest Leatherette/ Centre part Tartan cloth	/R 80- 80	1	SC
	911 522 006 28 8ZZ	Black/ Red/blue/black			
	911 522 006 28 8ZE	Dark blue/ Red/blue/black			
	911 522 006 28 2ZZ	Black/ Green/blue/black			
	911 522 006 28 2ZE	Dark blue/ Green/blue/black			
	911 522 006 28 4ZZ	Black/ Brown/white/beige			
	911 522 006 28 4ZS	Brown/ Brown/white/beige			
	911 522 006 28 4ZH	Beige/ Brown/white/beige			
(2)	911 522 005 29	Back seat backrest Leatherette/ Centre part Tartan cloth	/L (AUS) (F) 80- 80	1	SC
	911 522 005 29 8ZZ	Black/ Red/blue/black			
	911 522 005 29 8ZE	Dark blue/ Red/blue/black			
	911 522 005 29 2ZZ	Black/ Green/blue/black			
	911 522 005 29 2ZE	Dark blue/ Green/blue/black			
	911 522 005 29 4ZZ	Black/ Brown/white/beige			
	911 522 005 29 4ZS	Brown/ Brown/white/beige			
	911 522 005 29 4ZH	Beige/ Brown/white/beige			
(2)	911 522 006 29	Back seat backrest Leatherette/ Centre part Tartan cloth	/R (AUS) (F) 80- 80	1	SC
	911 522 006 29 8ZZ	Black/ Red/blue/black			
	911 522 006 29 8ZE	Dark blue/ Red/blue/black			
	911 522 006 29 2ZZ	Black/ Green/blue/black			
	911 522 006 29 2ZE	Dark blue/ Green/blue/black			
	911 522 006 29 4ZZ	Black/ Brown/white/beige			
	911 522 006 29 4ZS	Brown/ Brown/white/beige			
	911 522 006 29 4ZH	Beige/ Brown/white/beige			

Model: 911 78

Model life 1978>>1983

Pos	Part Number	Description	Remark	Qty	Model
(2)	911 522 017 01	Back seat backrest Leatherette/ Centre part Tartan cloth	/L 80	1	
	911 522 017 01 8ZZ	Black-red Red/blue/black			
	911 522 017 01 8ZE	Dark blue Red/blue/black			
	911 522 017 01 2ZZ	Black/ Green/blue/black			
	911 522 017 01 2ZE	Dark blue Green/blue/black			
	911 522 017 01 4ZZ	Black/ Brown/white/beige			
	911 522 017 01 4ZS	Brown/ Brown/white/beige			
	911 522 017 01 4ZH	Beige Brown/white/beige			
(2)	911 522 018 01	Back seat backrest Leatherette/ Centre part Tartan cloth	/R 80	1	
	911 522 018 01 8ZZ	Black/ Red/blue/black			
	911 522 018 01 8ZE	Dark blue/ Red/blue/black			
	911 522 018 01 2ZZ	Black/ Green/blue/black			
	911 522 018 01 2ZE	Dark blue/ Green/blue/black			
	911 522 018 01 4ZZ	Black/ Brown/white/beige			
	911 522 018 01 4ZS	Brown/ Brown/white/beige			
	911 522 018 01 4ZH	Beige/ Brown/white/beige			
(2)	911 522 005 28	Back seat backrest Leatherette/ Centre part Checker board velour	/L 80-	1	SC
	911 522 005 28 3ZP	Black/ Blue/black			
	911 522 005 28 BC1	Dark blue/ Blue/black			
	911 522 005 28 4ZP	Black/ Brown/black			
	911 522 005 28 4ZM	Brown/ Brown/black			
	911 522 005 28 4ZG	Beige/ Brown/black			
	911 522 005 28 FD8	Black/ Grey/black			
	911 522 005 28 FD9	Brown/ Beige/brown			
	911 522 005 28 BC4	Beige/ Beige/brown			
	911 522 005 28 LD5	Black/ Light grey/black	83- 83-		
	911 522 005 28 LJ8	Blue/ Blue-grey	83- 83-		
	911 522 005 28 LD6	Brown/ Brown-grey	83- 83-		
	911 522 005 28 LJ9	Burgundy/ Burgundy/	83- 83-		

Model: 911 78 Model life 1978>>1983

Pos	Part Number	Description	Remark	Qty	Model		
(2)	911 522 005 28 LK1	Burgundy-grey Grey-beige/ Light grey/black	83- 83- 83-	1	SC		
	911 522 006 28	Back seat backrest Leatherette/ Centre part Checker board velour	/R 80-				
	911 522 006 28 3ZP	Black/ Blue/black					
	911 522 006 28 BC1	Dark blue/ Blue/black					
	911 522 006 28 4ZP	Black/ Brown/black					
	911 522 006 28 4ZM	Brown/ Brown/black					
	911 522 006 28 4ZG	Beige/ Brown/black					
	911 522 006 28 FD8	Black/ Grey/black					
	911 522 006 28 FD9	Brown/ Beige/brown					
	911 522 006 28 BC4	Beige/ Beige/brown					
	911 522 006 28 LD5	Black/ Light grey/black	83- 83-				
	911 522 006 28 LJ8	Blue/ Blue-grey	83- 83-				
	911 522 006 28 LD6	Brown/ Brown-grey	83- 83-				
	911 522 006 28 LJ9	Burgundy/ Burgundy-grey	83- 83-				
	911 522 006 28 LK1	Grey-beige/ Light grey/black	83- 83-				
(2)	911 522 005 29	Back seat backrest	/L (AUS) (F) 80-			1	SC
		Leatherette/ Centre part Checker board velour					
	911 522 005 29 3ZP	Black/ Blue/black					
	911 522 005 29 BC1	Dark blue/ Blue/black					
	911 522 005 29 4ZP	Black/ Brown/black					
	911 522 005 29 4ZM	Brown/ Brown/black					
	911 522 005 29 4ZG	Beige/ Brown/black					
	911 522 005 29 FD8	Black/ Grey/black					
	911 522 005 29 FD9	Brown/ Beige/brown					
	911 522 005 29 BC4	Beige/ Beige/brown					
	911 522 005 29 LD5	Black/ Light grey/black	83- 83-				
	911 522 005 29 LJ8	Blue Blue-grey	83- 83-				
	911 522 005 29 LD6	Brown Brown-grey	83- 83-				
	911 522 005 29 LJ9	Grey-beige Burgundy-grey	83- 83-				
	911 522 005 29 LK1	Grey-beige/ Grey-beige/	83- 83-				

Model: 911 78 Model life 1978>>1983

Pos	Part Number	Description	Remark	Qty	Model
(2)	911 522 006 29	Light grey/black Back seat backrest	83- /R (AUS) (F) 80-	1	SC
		Leatherette/ Centre part Checker board velour			
	911 522 006 29 3ZP	Black/ Blue/black			
	911 522 006 29 BC1	Dark blue/ Blue/black			
	911 522 006 29 4ZP	Black/ Brown/black			
	911 522 006 29 4ZM	Brown/ Brown/black			
	911 522 006 29 4ZG	Beige/ Brown/black			
	911 522 006 29 FD8	Black/ Grey/black			
	911 522 006 29 FD9	Brown/ Beige/brown			
	911 522 006 29 BC4	Beige/ Beige/brown			
	911 522 006 29 LD5	Black	83-		
		Light grey/black	83-		
	911 522 006 29 LJ8	Blue/ Blue-grey	83- 83-		
	911 522 006 29 LD6	Brown Brown-grey	83- 83-		
	911 522 006 29 LJ9	Burgundy/ Burgundy-grey	83- 83-		
	911 522 006 29 LK1	Grey-beige Light grey/black	83- 83-		
(2)	911 522 017 01	Back seat backrest	/L	1	
		Leatherette/ Centre part Checker board velour			
	911 522 017 01 3ZP	Black/ Blue/black			
	911 522 017 01 BC1	Dark blue/ Blue/black			
	911 522 017 01 4ZP	Black/ Brown/black			
	911 522 017 01 4ZM	Brown/ Brown/black			
	911 522 017 01 4ZG	Beige/ Brown/black			
	911 522 017 01 FD8	Black/ Grey/black			
	911 522 017 01 FD9	Brown/ Beige/brown			
	911 522 017 01 BC4	Beige/ Beige/brown			
	911 522 017 01 LD5	Black	83-		
		Light grey/black	83-		
	911 522 017 01 LJ8	Blue Blue-grey	83- 83-		
	911 522 017 01 LD6	Brown Brown-grey	83- 83-		
	911 522 017 01 LJ9	Burgundy Burgundy-grey	83- 83-		
	911 522 017 01 LK1	Grey-beige Light grey/black	83- 83-		
(2)	911 522 018 01	Back seat backrest	/R	1	

Model: 911 78 Model life 1978>>1983

Pos	Part Number	Description	Remark	Qty	Model
		Leatherette/ Centre part Checker board velour			
	911 522 018 01 3ZP	Black/ Blue/black			
	911 522 018 01 BC1	Dark blue/ Blue/black			
	911 522 018 01 4ZP	Black/ Brown/black			
	911 522 018 01 4ZM	Brown/ Brown/black			
	911 522 018 01 4ZG	Beige Brown/black			
	911 522 018 01 FD8	Black/ Grey/black			
	911 522 018 01 FD9	Brown/ Beige/brown			
	911 522 018 01 BC4	Beige Beige/brown			
	911 522 018 01 LD5	Black Light grey/black	83- 83-		
	911 522 018 01 LJ8	Blue Blue-grey	83- 83-		
	911 522 018 01 LD6	Brown Brown-grey	83- 83-		
	911 522 018 01 LJ9	Burgundy Burgundy-grey	83- 83-		
	911 522 018 01 LK1	Grey-beige Light grey/black	83- 83-		
(2)	911 522 005 28	Back seat backrest Leatherette/ Centre part Uni-coloured cloth	/L 80-	1	SC
	911 522 005 28 BD4	Black/black	-82		
	911 522 005 28 4ZK	Brown/brown	-82		
	911 522 005 28 BD1	Dark blue/blue	-82		
	911 522 005 28 BD3	Beige/Beige			
	911 522 005 28 BD5	Brown/beige			
	911 522 005 28 LK3	Brown-brown	83-		
	911 522 005 28 LK5	Burgundy-burgundy	83-		
	911 522 005 28 LK6	Grey-beige/grey-beige	83-		
	911 522 005 28 JM2	Black-black	83-		
	911 522 005 28 JM5	Blue/blue	83-		
(2)	911 522 006 28	Back seat backrest Leatherette/ Centre part Uni-coloured cloth	/R 80-	1	SC
	911 522 006 28 BD4	Black/black	-82		
	911 522 006 28 4ZK	Brown/brown	-82		
	911 522 006 28 BD1	Dark blue/blue	-82		
	911 522 006 28 BD3	Beige/Beige			
	911 522 006 28 BD5	Brown/beige			
	911 522 006 28 LK3	Brown-brown	83-		
	911 522 006 28 LK5	Burgundy-burgundy	83-		
	911 522 006 28 LK6	Grey-beige/grey-beige	83-		
	911 522 006 28 JM2	Black-black	83-		
	911 522 006 28 JM5	Blue/blue	83-		
(2)	911 522 005 29	Back seat backrest Leatherette/ Centre part Uni-coloured cloth	/L (AUS) (F) 80-	1	SC
	911 522 005 29 BD4	Black/black	-82		

Model: 911 78 Model life 1978>>1983

Pos	Part Number	Description	Remark	Qty	Model
	911 522 005 29 4ZK	Brown/brown	-82		
	911 522 005 29 BD1	Dark blue/blue	-82		
	911 522 005 29 BD3	Beige/Beige			
	911 522 005 29 BD5	Brown/beige			
	911 522 005 29 LK3	Brown	83-		
	911 522 005 29 LK5	Burgundy	83-		
	911 522 005 29 LK6	Grey-beige	83-		
	911 522 005 29 JM2	Black-black	83-		
	911 522 005 29 JM5	Blue/blue	83-		
(2)	911 522 006 29	Back seat backrest Leatherette/ Centre part Uni-coloured cloth	/R (AUS) (F) 80-	1	SC
	911 522 006 29 BD4	Black/black	-82		
	911 522 006 29 4ZK	Brown/brown	-82		
	911 522 006 29 BD1	Dark blue/blue	-82		
	911 522 006 29 BD3	Beige/Beige			
	911 522 006 29 BD5	Brown/beige			
	911 522 006 29 LK3	Brown-brown	83-		
	911 522 006 29 LK5	Burgundy	83-		
	911 522 006 29 LK6	Grey-beige/grey-beige	83-		
	911 522 006 29 JM2	Black-black	83-		
	911 522 006 29 JM5	Blue	83-		
(2)	911 522 017 01	Back seat backrest Leatherette/ Centre part Uni-coloured cloth	/L	1	
	911 522 017 01 BD3	Beige			
	911 522 017 01 BD5	Brown/beige			
	911 522 017 01 LK3	Brown	83-		
	911 522 017 01 LK5	Burgundy	83-		
	911 522 017 01 LK6	Grey-beige	83-		
	911 522 017 01 JM2	Black	83-		
	911 522 017 01 JM5	Blue	83-		
(2)	911 522 018 01	Back seat backrest Leatherette/ Centre part Uni-coloured cloth	/R	1	
	911 522 018 01 BD3	Beige			
	911 522 018 01 BD5	Brown-beige			
	911 522 018 01 LK3	Brown	83-		
	911 522 018 01 LK5	Burgundy	83-		
	911 522 018 01 LK6	Grey-beige	83-		
	911 522 018 01 JM2	Black	83-		
	911 522 018 01 JM5	Blue	83-		
(2)	911 522 005 31	Back seat backrest Leatherette/ Backrest surface Berber cloth Carpet Cut pile	/L (AUS) (F) 80-	1	SC
	911 522 005 31 GE9	Black/ Grey/black	-82 -82		
	911 522 005 31 BD7	Dark blue/ Blue/black	-82 -82		
	911 522 005 31 FE3	Brown/ Beige/brown	-82 -82		
	911 522 005 31 BD9	Beige/ Beige/brown			
	911 522 005 31 LK8	Burgundy/ Burgundy-grey	83- 83-		

Model: 911 78 Model life 1978>>1983

Pos	Part Number	Description	Remark	Qty	Model
	911 522 006 30 GE9	Black/ Grey/black	-82 -82		
	911 522 006 30 BD7	Dark blue/ Blue/black	-82 -82		
	911 522 006 30 FE3	Brown/ Beige/brown	-82 -82		
	911 522 006 30 BD9	Beige/ Beige/brown			
	911 522 006 30 LK8	Burgundy/ Burgundy-grey	83- 83-		
	911 522 006 30 JM9	Grey-beige/ Grey-beige-grey	83- 83-		
	911 522 006 30 JM3	Black/ Grey/black	83- 83-		
	911 522 006 30 JM8	Blue/ Blue/black	83- 83-		
	911 522 006 30 JM4	Brown/ Beige/brown	83- 83-		
(2)	911 522 017 02	Back seat backrest Leatherette/ Backrest surface Berber cloth Carpet Cut pile	/L	1	
	911 522 017 02 BD9	Beige Beige/brown			
	911 522 017 02 LK8	Burgundy/ Burgundy-grey	83- 83-		
	911 522 017 02 JM9	Grey-beige/ Grey-beige-grey	83- 83-		
	911 522 017 02 JM3	Black/ Grey/black	83- 83-		
	911 522 017 02 JM8	Blue/ Blue/black	83- 83-		
	911 522 017 02 JM4	Brown/ Beige/brown	83- 83-		
(2)	911 522 018 02	Back seat backrest Leatherette/ Backrest surface Berber cloth Carpet Cut pile	/R	1	
	911 522 018 02 BD9	Beige Beige/brown			
	911 522 018 02 LK8	Burgundy/ Burgundy-grey	83- 83-		
	911 522 018 02 JM9	Grey-beige/ Grey-beige-grey	83- 83-		
	911 522 018 02 JM3	Black/ Grey/black	83- 83-		
	911 522 018 02 JM8	Blue/ Blue/black	83- 83-		
	911 522 018 02 JM4	Brown/ Beige/brown	83- 83-		
(2)	911 522 005 81	Back seat backrest Leather/ Carpet Cut pile	/L 79-	1	SC
	911 522 005 81 7AG	Black	-79		
	911 522 005 81 20B	Dark green	-82		
	911 522 005 81 3NG	Brown	-82		
	911 522 005 81 3AG	Blue	-79		
	911 522 005 81 8AT	Light red	-79		

Model: 911 78 Model life 1978>>1983

Pos	Part Number	Description	Remark	Qty	Model
	911 522 005 81 1AG	Yellow	-79		
	911 522 005 81 9AG	White	-79		
	911 522 005 81 5AH	Cork	-79		
	911 522 005 81 1AJ	Black	80-82		
	911 522 005 81 30B	Dark blue	80-82		
	911 522 005 81 50B	Beige	80-82		
	911 522 005 81 40D	Cork	80		
	911 522 005 81 30A	Blue	80		
	911 522 005 81 80B	Light red	80		
	911 522 005 81 10A	Yellow	80		
	911 522 005 81 99A	White	80		
	911 522 005 81 80S	Can-can-red	81-82		
	911 522 005 81 95S	Papyrus	81-		
	911 522 005 81 60S	Hannibal grey	81-		
	911 522 005 81 20S	Mint green	81-		
	911 522 005 81 LG7	Burgundy	83-		
	911 522 005 81 KZ4	Grey-beige	83-		
	911 522 005 81 KZ2	Black	83-		
	911 522 005 81 KZ3	Blue	83-		
	911 522 005 81 KZ5	Brown	83-		
	911 522 005 81 KZ6	Can-can-red	83-		
	911 522 005 81 LG4	Pearl white	83-		
	911 522 005 81 LG5	Champagne	83-		
	911 522 005 81 LG6	Dark green	83-		
(2)	911 522 006 81	Back seat backrest Leather/ Carpet Cut pile	/R 79-	1	
	911 522 006 81 7AG	Black	-79		
	911 522 006 81 20B	Dark green	-82		
	911 522 006 81 3NG	Brown	-82		
	911 522 006 81 3AG	Blue	-79		
	911 522 006 81 8AT	Light red	-79		
	911 522 006 81 1AG	Yellow	-79		
	911 522 006 81 9AG	White	-79		
	911 522 006 81 5AH	Cork	-79		
	911 522 006 81 1AJ	Black	80-82		
	911 522 006 81 30B	Dark blue	80-82		
	911 522 006 81 50B	Beige	80-82		
	911 522 006 81 40D	Cork	80		
	911 522 006 81 30A	Blue	80		
	911 522 006 81 80B	Light red	80		
	911 522 006 81 10A	Yellow	80		
	911 522 006 81 99A	White	80		
	911 522 006 81 80S	Can-can-red	81-82		
	911 522 006 81 95S	Papyrus	81-		
	911 522 006 81 60S	Hannibal grey	81-		
	911 522 006 81 20S	Mint green	81-		
	911 522 006 81 LG7	Burgundy	83-		
	911 522 006 81 KZ4	Grey-beige	83-		
	911 522 006 81 KZ2	Black	83-		
	911 522 006 81 KZ3	Blue	83-		
	911 522 006 81 KZ5	Brown	83-		
	911 522 006 81 KZ6	Can-can-red	83-		
	911 522 006 81 LG4	Pearl white	83-		
	911 522 006 81 LG5	Champagne	83-		
(2)	911 522 005 82	Back seat backrest Leather/ Carpet Cut pile	/L (AUS) (F) 79-	1	SC
	911 522 005 82 7AG	Black	-79		

Model: 911 78 Model life 1978>>1983

Pos	Part Number	Description	Remark	Qty	Model
	911 522 005 82 20B	Dark green	-82		
	911 522 005 82 3NG	Brown	-82		
	911 522 005 82 3AG	Blue	-79		
	911 522 005 82 8AT	Light red	-79		
	911 522 005 82 1AG	Yellow	-79		
	911 522 005 82 9AG	White	-79		
	911 522 005 82 5AH	Cork	-79		
	911 522 005 82 1AJ	Black	80-82		
	911 522 005 82 30B	Dark blue	80-82		
	911 522 005 82 50B	Beige	80-82		
	911 522 005 82 40D	Cork	80		
	911 522 005 82 30A	Blue	80		
	911 522 005 82 80B	Light red	80		
	911 522 005 82 10A	Yellow	80		
	911 522 005 82 99A	White	80		
	911 522 005 82 80S	Can-can-red	81-82		
	911 522 005 82 95S	Papyrus	81-		
	911 522 005 82 60S	Hannibal grey	81-		
	911 522 005 82 20S	Mint green	81-		
	911 522 005 82 LG7	Burgundy	83-		
	911 522 005 82 KZ4	Grey-beige	83-		
	911 522 005 82 KZ2	Black	83-		
	911 522 005 82 KZ3	Blue	83-		
	911 522 005 82 KZ5	Brown	83-		
	911 522 005 82 KZ6	Can-can-red	83-		
	911 522 005 82 LG4	Pearl white	83-		
	911 522 005 82 LG5	Champagne	83-		
	911 522 005 82 LG6	Dark green	83-		
(2)	911 522 006 82	Back seat backrest	/R (AUS) (F) 79-	1	
		Leather/ Carpet Cut pile			
	911 522 006 82 7AG	Black	-79		
	911 522 006 82 20B	Dark green	-82		
	911 522 006 82 3NG	Brown	-82		
	911 522 006 82 3AG	Blue	-79		
	911 522 006 82 8AT	Light red	-79		
	911 522 006 82 1AG	Yellow	-79		
	911 522 006 82 9AG	White	-79		
	911 522 006 82 5AH	Cork	-79		
	911 522 006 82 1AJ	Black	80-82		
	911 522 006 82 30B	Dark blue	80-82		
	911 522 006 82 50B	Beige	80-82		
	911 522 006 82 40D	Cork	80		
	911 522 006 82 30A	Blue	80		
	911 522 006 82 80B	Light red	80		
	911 522 006 82 10A	Yellow	80		
	911 522 006 82 99A	White	80		
	911 522 006 82 80S	Can-can-red	81-82		
	911 522 006 82 95S	Papyrus	81-		
	911 522 006 82 60S	Hannibal grey	81-		
	911 522 006 82 20S	Mint green	81-		
	911 522 006 82 LG7	Burgundy	83-		
	911 522 006 82 KZ4	Grey-beige	83-		
	911 522 006 82 KZ2	Black	83-		
	911 522 006 82 KZ3	Blue	83-		
	911 522 006 82 KZ5	Brown	83-		
	911 522 006 82 KZ6	Can-can-red	83-		
	911 522 006 82 LG4	Pearl white	83-		
	911 522 006 82 LG5	Champagne	83-		
	911 522 006 82 LG6	Dark green	83-		
(2)	911 522 017 03	Back seat backrest	/L	1	

Model: 911 78 Model life 1978>>1983

Pos	Part Number	Description	Remark	Qty	Model
		Leather/ Carpet Cut pile			
	911 522 017 03 95S	Papyrus	81-		
	911 522 017 03 60S	Hannibal grey	81-		
	911 522 017 03 20S	Mint green	81-		
	911 522 017 03 LG7	Burgundy	83-		
	911 522 017 03 KZ4	Grey-beige	83-		
	911 522 017 03 KZ2	Black	83-		
	911 522 017 03 KZ3	Blue	83-		
	911 522 017 03 KZ5	Brown	83-		
	911 522 017 03 KZ6	Can-can-red	83-		
	911 522 017 03 LG4	Pearl white	83-		
	911 522 017 03 LG5	Champagne	83-		
	911 522 017 03 LG6	Dark green	83-		
(2)	911 522 018 03	Back seat backrest Leather/ Carpet Cut pile	/R	1	
	911 522 018 03 95S	Papyrus	81-		
	911 522 018 03 60S	Hannibal grey	81-		
	911 522 018 03 20S	Mint green	81-		
	911 522 018 03 LG7	Burgundy	83-		
	911 522 018 03 KZ4	Grey-beige	83-		
	911 522 018 03 KZ2	Black	83-		
	911 522 018 03 KZ3	Blue	83-		
	911 522 018 03 KZ5	Brown	83-		
	911 522 018 03 KZ6	Can-can-red	83-		
	911 522 018 03 LG4	Pearl white	83-		
	911 522 018 03 LG5	Champagne	83-		
	911 522 018 03 LG6	Dark green	83-		
(2)	911 522 005 81	Back seat backrest Leather/ Piping	/L 79-	1	SC
	911 522 005 81 6AD	Russet Doric grey			
(2)	911 522 017 03	Back seat backrest Leather/ Piping	/L	1	
	911 522 017 03 6AD	Russet Doric grey			
(2)	911 522 006 81	Back seat backrest Leather/ Piping	/R 79-	1	
	911 522 006 81 6AD	Doric grey Doric grey			
(2)	911 522 005 82	Back seat backrest Leather/ Piping	/L (AUS) (F) 79-	1	SC
	911 522 005 82 6AD	Russet Doric grey			
(2)	911 522 017 03	Back seat backrest Leather/ Piping	/L	1	
	911 522 017 03 6AD	Russet Doric grey			
(2)	911 522 006 82	Back seat backrest Leather/ Piping	/R (AUS) (F) 79-	1	
	911 522 006 82 6AD	Russet Doric grey			

Model: 911 78

Model life 1978>>1983

Pos	Part Number	Description	Remark	Qty	Model
(2)	930 522 005 74	Back seat backrest Leather/ Carpet Cut pile with Logo	/L 79-	1	TURBO
	930 522 005 74 5AH	Cork	-79		
	930 522 005 74 7AG	Black	-79		
	930 522 005 74 20B	Dark green	-80		
	930 522 005 74 3NG	Brown	-82		
	930 522 005 74 3AG	Blue	-79		
	930 522 005 74 8AT	Light red	-79		
	930 522 005 74 1AG	Yellow	-79		
	930 522 005 74 9AG	White	-79		
	930 522 005 74 30B	Dark blue	80-82		
	930 522 005 74 50B	Beige	80-82		
	930 522 005 74 1AJ	Black	80-82		
	930 522 005 74 40D	Cork	80		
	930 522 005 74 30A	Blue	80		
	930 522 005 74 80B	Light red	80		
	930 522 005 74 10A	Yellow	80		
	930 522 005 74 99A	White	80		
	930 522 005 74 80S	Can-can-red	81-82		
	930 522 005 74 95S	Papyrus	81-82		
	930 522 005 74 60S	Hannibal grey	81-82		
	930 522 005 74 20S	Mint green	81-82		
	930 522 005 74 LG7	Burgundy	83-		
	930 522 005 74 KZ3	Blue	83-		
	930 522 005 74 KZ4	Grey-beige	83-		
	930 522 005 74 KZ5	Brown	83-		
	930 522 005 74 KZ6	Can-can-red	83-		
	930 522 005 74 LG4	Pearl white	83-		
	930 522 005 74 LG5	Champagne	83-		
	930 522 005 74 LG6	Dark green	83-		
	930 522 005 74 KZ2	Black	83-		
(2)	930 522 005 75	Back seat backrest Leather/ Carpet Cut pile with Logo	/L (AUS) (F) 79-	1	TUR
	930 522 005 75 5AH	Cork	-79		
	930 522 005 75 7AG	Black	-79		
	930 522 005 75 20B	Dark green	-80		
	930 522 005 75 3NG	Brown	-82		
	930 522 005 75 3AG	Blue	-79		
	930 522 005 75 8AT	Light red	-79		
	930 522 005 75 1AG	Yellow	-79		
	930 522 005 75 9AG	White	-79		
	930 522 005 75 30B	Dark blue	80-82		
	930 522 005 75 50B	Beige	80-82		
	930 522 005 75 1AJ	Black	80-82		
	930 522 005 75 40D	Cork	80		
	930 522 005 75 30A	Blue	80		
	930 522 005 75 80B	Light red	80		
	930 522 005 75 10A	Yellow	80		
	930 522 005 75 99A	White	80		
	930 522 005 75 80S	Can-can-red	81-82		
	930 522 005 75 95S	Papyrus	81-82		
	930 522 005 75 60S	Hannibal grey	81-82		
	930 522 005 75 20S	Mint green	81-82		
	930 522 005 75 LG7	Burgundy	83-		

Model: 911 78 Model life 1978>>1983

Pos	Part Number	Description	Remark	Qty	Model
	930 522 005 75 KZ3	Blue	83-		
	930 522 005 75 KZ4	Grey-beige	83-		
	930 522 005 75 KZ5	Brown	83-		
	930 522 005 75 KZ6	Can-can-red	83-		
	930 522 005 75 LG4	Pearl white	83-		
	930 522 005 75 LG5	Champagne	83-		
	930 522 005 75 LG6	Dark green	83-		
	930 522 005 75 KZ2	Black	83-		
(2)	911 522 005 83	Back seat backrest Leather/ Centre part Checker board velour	/L 80-	1	SC
	911 522 005 83 AJ1	Dark blue/ Blue/black			
	911 522 005 83 AJ2	Black/ Grey/black			
	911 522 005 83 AJ3	Brown/ Beige/brown			
	911 522 005 83 AJ4	Beige/ Beige/brown			
	911 522 005 83 LH1	Black	83-		
		Light grey/black	83-		
	911 522 005 83 LH3	Blue	83-		
		Blue-grey	83-		
	911 522 005 83 LH2	Brown/ Brown-grey	83- 83-		
	911 522 005 83 LH4	Burgundy/ Burgundy-grey	83- 83-		
	911 522 005 83 LH6	Grey-beige/ Light grey/black	83- 83-		
(2)	930 522 005 76	Back seat backrest Leather/ Centre part Checker board velour	/L 80-	1	TURBO
	930 522 005 76 AJ1	Dark blue/ Blue/black			
	930 522 005 76 AJ2	Black/ Grey/black			
	930 522 005 76 AJ3	Brown/ Beige/brown			
	930 522 005 76 AJ4	Beige/ Beige/brown			
	930 522 005 76 LH1	Black/ Light grey/black	83- 83-		
	930 522 005 76 LH3	Blue/ Blue-grey	83- 83-		
	930 522 005 76 LH2	Brown/ Brown-grey	83- 83-		
	930 522 005 76 LH4	Burgundy/ Burgundy-grey	83- 83-		
	930 522 005 76 LH6	Grey-beige/ Light grey/black	83- 83-		
(2)	911 522 006 83	Back seat backrest Leather/ Centre part Checker board velour	/R 80-	1	
	911 522 006 83 AJ1	Dark blue/ Blue/black			
	911 522 006 83 AJ2	Black/ Grey/black			
	911 522 006 83 AJ3	Brown/ Beige/brown			
	911 522 006 83 AJ4	Beige/ Beige/brown			

Model: 911 78 Model life 1978>>1983

Pos	Part Number	Description	Remark	Qty	Model
	911 522 006 83 LH1	Beige/brown Black/ Light grey/black	83- 83- 83-		
	911 522 006 83 LH3	Blue Blue-grey	83- 83-		
	911 522 006 83 LH2	Brown Brown-grey	83- 83-		
	911 522 006 83 LH4	Burgundy Burgundy-grey	83- 83-		
	911 522 006 83 LH6	Grey-beige Light grey/black	83- 83-		
(2)	911 522 005 84	Back seat backrest Leather/ Centre part Checker board velour	/L (AUS) (F) 80-	1	SC
	911 522 005 84 AJ1	Dark blue/ Blue/black			
	911 522 005 84 AJ2	Black/ Grey/black			
	911 522 005 84 AJ3	Brown/ Beige/brown			
	911 522 005 84 AJ4	Beige/ Beige/brown			
	911 522 005 84 LH1	Black/ Light grey/black	83- 83-		
	911 522 005 84 LH3	Blue/ Blue-grey	83- 83-		
	911 522 005 84 LH2	Brown Brown-grey	83- 83-		
	911 522 005 84 LH4	Burgundy/ Burgundy-grey	83- 83-		
	911 522 005 84 LH6	Grey-beige Light grey/black	83- 83-		
(2)	930 522 005 77	Back seat backrest Leather/ Centre part Checker board velour	/L (AUS) (F) 80-	1	TUR
	930 522 005 77 AJ1	Dark blue/ Blue/black			
	930 522 005 77 AJ2	Black/ Grey/black			
	930 522 005 77 AJ3	Brown/ Beige/brown			
	930 522 005 77 AJ4	Beige/ Beige/brown			
	930 522 005 77 LH1	Black/ Light grey/black	83- 83-		
	930 522 005 77 LH3	Blue/ Blue-grey	83- 83-		
	930 522 005 77 LH2	Brown/ Brown-grey	83- 83-		
	930 522 005 77 LH4	Burgundy/ Burgundy-grey	83- 83-		
	930 522 005 77 LH6	Grey-beige/ Light grey/black	83- 83-		
(2)	911 522 006 84	Back seat backrest Leather/ Centre part Checker board velour	/R (AUS) (F) 80-	1	
	911 522 006 84 AJ1	Dark blue/			

Model: 911 78 Model life 1978>>1983

Pos	Part Number	Description	Remark	Qty	Model
	911 522 006 84 AJ2	Blue/black Black/ Grey/black			
	911 522 006 84 AJ3	Brown/ Beige/brown			
	911 522 006 84 AJ4	Beige/ Beige/brown			
	911 522 006 84 LH1	Black/ Light grey/black	83-		
	911 522 006 84 LH3	Blue Blue-grey	83-		
	911 522 006 84 LH2	Brown/ Brown-grey	83-		
	911 522 006 84 LH4	Burgundy Burgundy-grey	83-		
	911 522 006 84 LH6	Grey-beige Light grey/black	83-		
(2)	911 522 005 83	Back seat backrest Leather/ Centre part Uni-coloured cloth	/L 80-	1	SC
	911 522 005 83 AK1	Dark blue/blue	-82		
	911 522 005 83 AK5	Brown/beige			
	911 522 005 83 AK3	Beige/Beige			
	911 522 005 83 AK4	Black/black	-82		
	911 522 005 83 LJ1	Brown/brown	83-		
	911 522 005 83 LJ2	Burgundy/burgundy	83-		
	911 522 005 83 LJ3	Grey-beige/grey-beige	83-		
	911 522 005 83 JN6	Black/black	83-		
	911 522 005 83 JT4	Blue/blue	83-		
(2)	930 522 005 76	Back seat backrest Leather/ Centre part Uni-coloured cloth	/L 80-	1	TURBO
	930 522 005 76 AK1	Dark blue/blue	-82		
	930 522 005 76 AK5	Brown/beige			
	930 522 005 76 AK3	Beige/Beige			
	930 522 005 76 AK4	Black/black	-82		
	930 522 005 76 LJ1	Brown-brown	83-		
	930 522 005 76 LJ2	Burgundy-burgundy	83-		
	930 522 005 76 LJ3	Grey-beige/grey-beige	83-		
	930 522 005 76 JN6	Black-black	83-		
	930 522 005 76 JT4	Blue/blue	83-		
(2)	911 522 006 83	Back seat backrest Leather/ Centre part Uni-coloured cloth	/R 80-	1	
	911 522 006 83 AK1	Dark blue/blue	-82		
	911 522 006 83 AK5	Brown/beige			
	911 522 006 83 AK3	Beige/Beige			
	911 522 006 83 AK4	Black/black	-82		
	911 522 006 83 LJ1	Brown	83-		
	911 522 006 83 LJ2	Burgundy-burgundy	83-		
	911 522 006 83 LJ3	Grey-beige	83-		
	911 522 006 83 JN6	Black-black	83-		
	911 522 006 83 JT4	Blue/blue	83-		
(2)	911 522 005 84	Back seat backrest Leather/ Centre part Uni-coloured cloth	/L (AUS) (F) 80-	1	SC
	911 522 005 84 AK1	Dark blue/blue	-82		
	911 522 005 84 AK5	Brown/beige			

Model: 911 78 Model life 1978>>1983

Pos	Part Number	Description	Remark	Qty	Model
	911 522 005 84 AK3	Beige/Beige			
	911 522 005 84 AK4	Black/black	-82		
	911 522 005 84 LJ1	Brown	83-		
	911 522 005 84 LJ2	Burgundy-burgundy	83-		
	911 522 005 84 LJ3	Grey-beige/grey-beige	83-		
	911 522 005 84 JN6	Black/black	83-		
	911 522 005 84 JT4	Blue/blue	83-		
(2)	930 522 005 77	Back seat backrest	/L (AUS) (F) 80-	1	TUR
		Leather/ Centre part Uni-coloured cloth			
	930 522 005 77 AK1	Dark blue/blue	-82		
	930 522 005 77 AK5	Brown/beige			
	930 522 005 77 AK3	Beige/Beige			
	930 522 005 77 AK4	Black/black	-82		
	930 522 005 77 LJ1	Brown/brown	83-		
	930 522 005 77 LJ2	Burgundy-burgundy	83-		
	930 522 005 77 LJ3	Grey-beige/grey-beige	83-		
	930 522 005 77 JN6	Black-black	83-		
	930 522 005 77 JT4	Blue/blue	83-		
(2)	911 522 006 84	Back seat backrest	/R (AUS) (F) 80-	1	
		Leather/ Centre part Uni-coloured cloth			
	911 522 006 84 AK1	Dark blue/blue	-82		
	911 522 006 84 AK5	Brown/beige			
	911 522 006 84 AK3	Beige/Beige			
	911 522 006 84 AK4	Black/black	-82		
	911 522 006 84 LJ1	Brown/brown	83-		
	911 522 006 84 LJ2	Burgundy-burgundy	83-		
	911 522 006 84 LJ3	Grey-beige/grey-beige	83-		
	911 522 006 84 JN6	Black-black	83-		
	911 522 006 84 JT4	Blue/blue	83-		
(2)	911 522 005 83	Back seat backrest	/L 80-	1	SC
		Leather/ Centre part Stripe design			M403
	911 522 005 83 HS6	Burgundy/ Grey-burgundy			
(2)	930 522 005 76	Back seat backrest	/L 80-	1	TURBO
		Leather/ Centre part Stripe design			M403
	930 522 005 76 HS6	Burgundy/ Grey-burgundy			
(2)	911 522 006 83	Back seat backrest	/R 80-	1	
		Leather/ Centre part Stripe design			M403
	911 522 006 83 HS6	Burgundy/ Grey-burgundy			
(2)	911 522 005 84	Back seat backrest	/L (AUS) (F) 80-	1	SC
		Leather/ Centre part Stripe design			M403
	911 522 005 84 HS6	Burgundy/ Grey-burgundy			
(2)	930 522 005 77	Back seat backrest	/L (AUS) (F) 80-	1	TUR
		Leather/			

Model: 911 78 Model life 1978>>1983

Pos	Part Number	Description	Remark	Qty	Model
		Centre part Stripe design			M403
(2)	930 522 005 77 HS6	Burgundy/ Grey-burgundy			
	911 522 006 84	Back seat backrest	/R (AUS) (F) 80-	1	
		Leather/ Centre part Stripe design			M403
	911 522 006 84 HS6	Burgundy/ Grey-burgundy			
(2)	911 522 005 85	Back seat backrest	/L 80-	1	SC
		Leather/ Backrest surface Berber cloth Carpet Cut pile			
	911 522 005 85 AK6	Black/ Grey/black	-82 -82		
	911 522 005 85 AK7	Dark blue/ Blue/black	-82 -82		
	911 522 005 85 AK8	Brown/ Beige/brown	-82 -82		
	911 522 005 85 AK9	Beige/ Beige/brown			
	911 522 005 85 LH8	Burgundy/ Burgundy-grey	83- 83-		
	911 522 005 85 LH9	Grey-beige/ Grey-beige-grey	83- 83-		
	911 522 005 85 JH1	Black/ Grey/black	83- 83-		
	911 522 005 85 JD4	Blue/ Blue/black	83- 83-		
	911 522 005 85 JH2	Brown/ Beige/brown	83- 83-		
(2)	930 522 005 78	Back seat backrest	/L 80-	1	TURBO
		Leather/ Backrest surface Berber cloth Carpet Cut pile			
	930 522 005 78 AK6	Black/ Grey/black	-82 -82		
	930 522 005 78 AK7	Dark blue/ Blue/black	-82 -82		
	930 522 005 78 AK8	Brown/ Beige/brown	-82 -82		
	930 522 005 78 AK9	Beige/ Beige/brown			
	930 522 005 78 LH8	Burgundy/ Burgundy-grey	83- 83-		
	930 522 005 78 LH9	Grey-beige/ Grey-beige-grey	83- 83-		
	930 522 005 78 JH1	Black/ Grey/black	83- 83-		
	930 522 005 78 JD4	Blue/ Blue/black	83- 83-		
	930 522 005 78 JH2	Brown/ Beige/brown	83- 83-		
(2)	911 522 006 85	Back seat backrest	/R	1	
		Leather/ Backrest surface Berber cloth			

Model: 911 78 Model life 1978>>1983

Pos	Part Number	Description	Remark	Qty	Model
		Carpet Cut pile			
	911 522 006 85 AK9	Beige/ Beige/brown			
	911 522 006 85 LH8	Burgundy/ Burgundy-grey	83- 83-		
	911 522 006 85 LH9	Grey-beige/ Grey-beige-grey	83- 83-		
	911 522 006 85 JH1	Black/ Grey/black	83- 83-		
	911 522 006 85 JD4	Blue/ Blue/black	83- 83-		
	911 522 006 85 JH2	Brown/ Beige/brown	83- 83-		
(2)	911 522 005 86	Back seat backrest	/L (AUS) (F) 80-	1	SC
		Leather/ Backrest surface Berber cloth Carpet Cut pile			
	911 522 005 86 AK6	Black/ Grey/black	-82 -82		
	911 522 005 86 AK7	Dark blue/ Blue/black	-82 -82		
	911 522 005 86 AK8	Brown/ Beige/brown	-82 -82		
	911 522 005 86 AK9	Beige/ Beige/brown			
	911 522 005 86 LH8	Burgundy/ Burgundy-grey	83- 83-		
	911 522 005 86 LH9	Grey-beige/ Grey-beige-grey	83- 83-		
	911 522 005 86 JH1	Black/ Grey/black	83- 83-		
	911 522 005 86 JD4	Blue/ Blue/black	83- 83-		
	911 522 005 86 JH2	Brown/ Beige/brown	83- 83-		
(2)	930 522 005 79	Back seat backrest	/L (AUS) (F) 80-	1	TUR
		Leather/ Backrest surface Berber cloth Carpet Cut pile			
	930 522 005 79 AK6	Black/ Grey/black	-82 -82		
	930 522 005 79 AK7	Dark blue/ Blue/black	-82 -82		
	930 522 005 79 AK8	Brown/ Beige/brown	-82 -82		
	930 522 005 79 AK9	Beige/ Beige/brown			
	930 522 005 79 LH8	Burgundy/ Burgundy-grey	83- 83-		
	930 522 005 79 LH9	Grey-beige/ Grey-beige-grey	83- 83-		
	930 522 005 79 JH1	Black/ Grey/black	83- 83-		
	930 522 005 79 JD4	Blue/ Blue/black	83- 83-		
	930 522 005 79 JH2	Brown/ Beige/brown	83- 83-		

Model: 911 78 Model life 1978>>1983

Pos	Part Number	Description	Remark	Qty	Model
(2)	911 522 006 86	Beige/brown Back seat backrest	83- /R (AUS) (F) 80-	1	
	911 522 006 86 AK6	Leather/ Backrest surface Berber cloth Carpet Cut pile Black/ Grey/black	-82 -82		
	911 522 006 86 AK7	Dark blue/ Blue/black	-82 -82		
	911 522 006 86 AK8	Brown/ Beige/brown	-82 -82		
	911 522 006 86 AK9	Beige/ Beige/brown	-82		
	911 522 006 86 LH8	Burgundy/ Burgundy-grey	83- 83-		
	911 522 006 86 LH9	Grey-beige/ Grey-beige-grey	83- 83-		
	911 522 006 86 JH1	Black/ Grey/black	83- 83-		
	911 522 006 86 JD4	Blue/ Blue/black	83- 83-		
	911 522 006 86 JH2	Brown/ Beige/brown	83- 83-		
3	900 236 001 07	Oval-head screw M 8 X 10		2	
3	900 236 001 03	Oval-head screw M 8 X 10		2	
4	N 012 230 1	Spring washer B 10		2	
5	901 522 509 20	Bearing sleeve		2	
6	911 559 435 00	Spacer		X	
7	901 522 063 40	Retaining belt		2	
(7)	911 645 039 00	Retaining belt Stereo rear loudspeaker		2	
7A	911 645 037 00	Retaining belt Extension Stereo rear loudspeaker		2	
-	999 591 802 17	Cap		2	
8	900 143 004 00	Cross-recess screw B 3,5 X 19		2	
9	999 591 805 12	Push button		2	
10	900 145 041 07	Tapping screw B 3,5 X 16		2	
11	999 591 102 17	Washer A 3,5		4	
11	999 591 102 1H	Washer A 3,5		4	
12	901 522 365 20	Cap		2	
13	911 522 229 00	Bolt	(AUS)	2	
14	911 522 233 00	Spring	(AUS)	2	
15	911 522 231 00	Knob	(AUS)	2	

Model: 911 78

Model life 1978>>1983

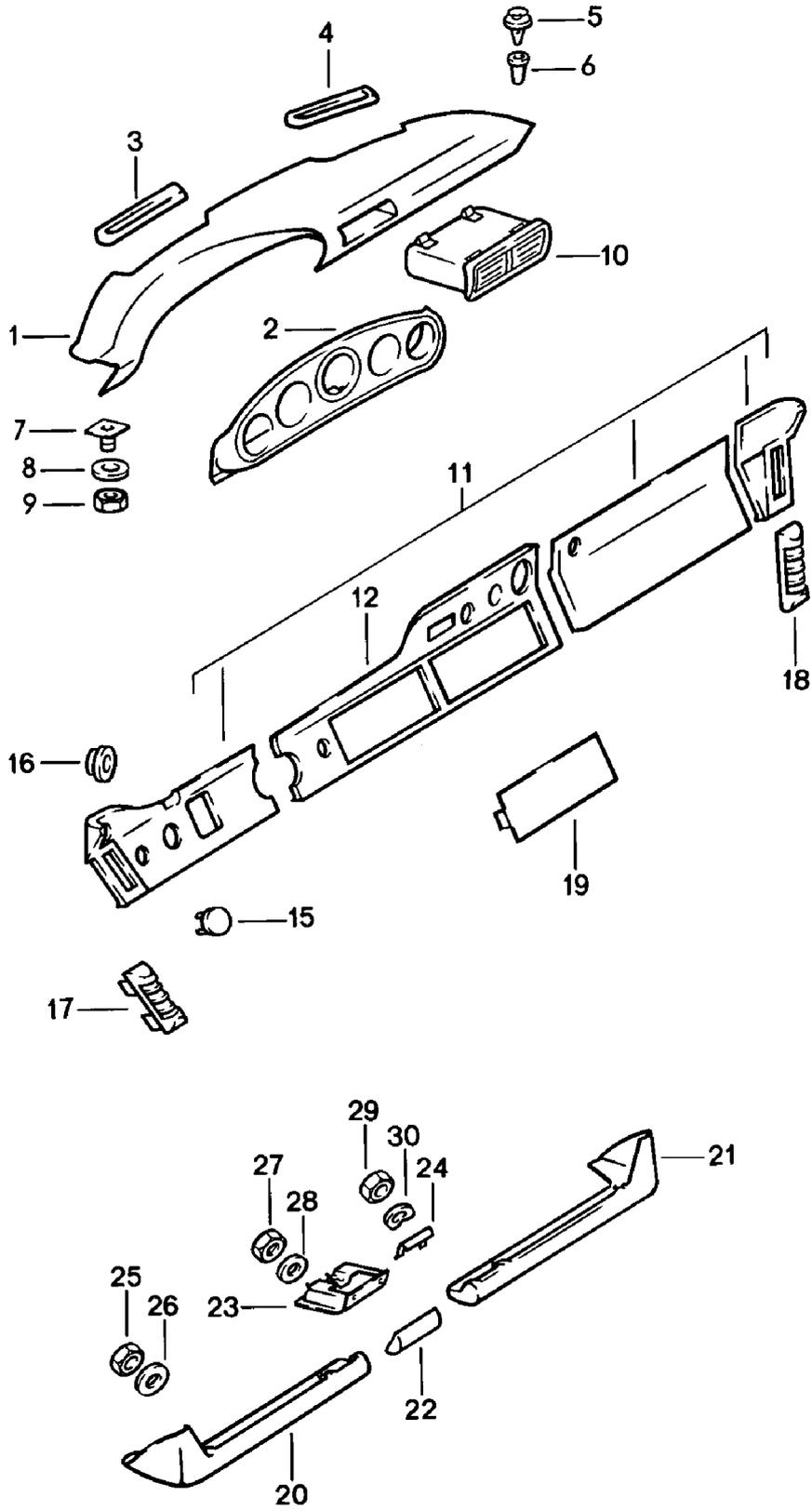

Model: 911 78 Model life 1978>>1983

Pos	Part Number	Description	Remark	Qty	Model
1	911 552 055 02	Dashboard with Installation parts Dashboard trim Leatherette	/LL	1	SC
	911 552 055 02 7AE	Black			
	911 552 055 02 8AE	Lobster	-78		
	911 552 055 02 5AE	Cork			
	911 552 055 02 21S	Brown	79-82		
	911 552 055 02 30B	Dark blue	80-		
	911 552 055 02 3MX	Burgundy	83-		
	911 552 055 02 4RB	Brown	83-		
(1)	911 552 056 02	Dashboard trim Leatherette	/RL	1	SC
	911 552 056 02 7AE	Black			
	911 552 056 02 8AE	Lobster	-78		
	911 552 056 02 5AE	Cork			
	911 552 056 02 21S	Brown	79-82		
	911 552 056 02 30B	Dark blue	80-		
	911 552 056 02 3MX	Burgundy	83-		
	911 552 056 02 4RB	Brown	83-		
1	911 552 055 04	Dashboard trim Leatherette	/LL	1	SC
	911 552 055 04 7AE	Black			
	911 552 055 04 8AE	Lobster	-78		
	911 552 055 04 5AE	Cork			
	911 552 055 04 21S	Brown	79-82		
	911 552 055 04 30B	Dark blue	80-		
	911 552 055 04 3MX	Burgundy	83-		
	911 552 055 04 4RB	Brown	83-		
1	911 552 055 06	Dashboard trim Leatherette	/LL	1	SC
	911 552 055 06 7AE	Black			
1	911 552 055 07	Dashboard trim Leatherette	/LL	1	SC
	911 552 055 07 7AE	Black			
(1)	911 552 056 04	Dashboard trim Leatherette	/RL	1	SC
	911 552 056 04 7AE	Black			
	911 552 056 04 8AE	Lobster	-78		
	911 552 056 04 5AE	Cork			
	911 552 056 04 21S	Brown	79-82		
	911 552 056 04 30B	Dark blue	80-		
	911 552 056 04 3MX	Burgundy	83-		
	911 552 056 04 4RB	Brown	83-		
1	911 552 055 71	Dashboard trim Leather	/LL	1	
	911 552 055 71 7AG	Black	-79		
	911 552 055 71 8AH	Lobster	-78		
	911 552 055 71 5AH	Cork	-79		
	911 552 055 71 20B	Dark green	-82		
	911 552 055 71 3NG	Dark brown	-82		
	911 552 055 71 3AG	Blue	-79		
	911 552 055 71 8AT	Light red	-79		
	911 552 055 71 1AJ	Black	80-82		
	911 552 055 71 30B	Dark blue	80-82		
	911 552 055 71 30A	Blue	80		
	911 552 055 71 40D	Cork	80		
	911 552 055 71 60S	Hannibal grey	81-		
	911 552 055 71 20S	Mint green	81-		
	911 552 055 71 6AD	Doric grey	80		
	911 552 055 71 2LB	Burgundy			
	911 552 055 71 LG7	Burgundy	83-		

Model: 911 78 Model life 1978>>1983

Pos	Part Number	Description	Remark	Qty	Model
	911 552 055 71 LG6	Dark green	83-		
	911 552 055 71 KZ2	Black	83-		
	911 552 055 71 KZ3	Blue	83-		
	911 552 055 71 KZ5	Brown	83-		
(1)	911 552 056 72	Dashboard trim	/RL	1	
		Leather			
	911 552 056 72 7AG	Black	-79		
	911 552 056 72 8AH	Lobster	-78		
	911 552 056 72 5AH	Cork	-79		
	911 552 056 72 20B	Dark green	-82		
	911 552 056 72 3NG	Dark brown	-82		
	911 552 056 72 3AG	Blue	-79		
	911 552 056 72 8AT	Light red	-79		
	911 552 056 72 1AJ	Black	80-82		
	911 552 056 72 30B	Dark blue	80-82		
	911 552 056 72 30A	Blue	80		
	911 552 056 72 40D	Cork	80		
	911 552 056 72 60S	Hannibal grey	81-		
	911 552 056 72 20S	Mint green	81-		
	911 552 056 72 6AD	Doric grey	80		
	911 552 056 72 2LB	Burgundy			
	911 552 056 72 LG7	Burgundy	83-		
	911 552 056 72 LG6	Dark green	83-		
	911 552 056 72 KZ2	Black	83-		
	911 552 056 72 KZ3	Blue	83-		
	911 552 056 72 KZ5	Brown	83-		
2	911 552 549 00	Cover	/LL	1	
(2)	911 552 550 00	Cover	/RL	1	
		Dashboard trim			
2	911 552 549 00	Cover	/LL	1	
		Dashboard trim			
	911 552 549 00 700	Black			
(2)	911 552 550 00	Cover	/RL	1	
		Dashboard trim			
	911 552 550 00 700	Black			
3	911 552 409 00	Cover	/L	1	
4	911 552 410 00	Cover	/R	1	
		Heating nozzle			
5	999 591 310 40	Fixing clip		7	
6	999 591 311 40	Bush		7	
7	999 591 344 02	Latch		2	
8	N 011 524 7	Washer		7	
		A 6,4			
8	N 011 524 27	Washer		7	
		A 6,4			
9	999 090 003 02	Lock nut		7	
		M 6			
(10)	911 571 067 02	Centre nozzle		1	
(10)	911 571 067 03	Centre nozzle		1	M559
-	911 571 181 01	Gasket		2	M399/559
		Centre nozzle			
(11)	911 552 041 10	Cover	/LL	1	
(11)	911 552 942 01	Cover	/RL	1	
		Set			
12	911 552 479 09	Cover	/LL	1	
	911 552 479 09 7AE	Black			
		Centre			
(12)	911 552 480 08	Cover	/RL -80	1	
		Centre			
(12)	911 552 944 01	Cover	/RL 81-	1	
	911 552 944 01 7AE	Black			
		Centre			
15	911 552 471 01	Trim cover		1	

Model: 911 78 Model life 1978>>1983

Pos	Part Number	Description	Remark	Qty	Model
16	911 552 217 00	Hazard warning light sw. Rosette Lid-release cable		1	
17	911 552 071 00	Side vent	/L	1	
18	911 552 072 00	Side vent	/R	1	
(19)	911 552 463 02	Trim cover Radio		1	
20	901 552 035 27	Knee protection strip Leatherette	/L	1	SC
	901 552 035 27 7AE	Black			
	901 552 035 27 8AE	Lobster	-78		
	901 552 035 27 5AE	Cork			
	901 552 035 27 21S	Brown	79-82		
	901 552 035 27 30B	Dark blue	80-82		
	901 552 035 27 3MX	Burgundy	83-		
	901 552 035 27 4RB	Brown	83-		
20	901 552 035 70	Knee protection strip Leather	/L	1	
	901 552 035 70 7AG	Black	-79		
	901 552 035 70 8AH	Lobster	-78		
	901 552 035 70 5AH	Cork	-79		
	901 552 035 70 20B	Dark green			
	901 552 035 70 3NG	Dark brown			
	901 552 035 70 3AG	Blue	-79		
	901 552 035 70 8AT	Light red	-79		
	901 552 035 70 1AJ	Black	80-82		
	901 552 035 70 30B	Dark blue	80-82		
	901 552 035 70 30A	Blue	80		
	901 552 035 70 40D	Cork	80		
	901 552 035 70 60S	Hannibal grey	81-		
	901 552 035 70 20S	Mint green	81-		
	901 552 035 70 6AD	Doric grey	80		
	901 552 035 70 2LB	Burgundy			
	901 552 035 70 LG7	Burgundy	83-		
	901 552 035 70 LG6	Dark green	83-		
	901 552 035 70 KZ2	Black	83-		
	901 552 035 70 KZ3	Blue	83-		
	901 552 035 70 KZ5	Brown	83-		
21	901 552 036 27	Knee protection strip Leatherette	/R	1	SC
	901 552 036 27 7AE	Black			
	901 552 036 27 8AE	Lobster	-78		
	901 552 036 27 5AE	Cork			
	901 552 036 27 21S	Brown	79-82		
	901 552 036 27 30B	Dark blue	80-		
	901 552 036 27 3MX	Burgundy	83-		
	901 552 036 27 4RB	Brown	83-		
21	901 552 036 70	Knee protection strip Leather	/R	1	
	901 552 036 70 7AG	Black	-79		
	901 552 036 70 8AH	Lobster	-78		
	901 552 036 70 5AH	Cork	-79		
	901 552 036 70 20B	Dark green			
	901 552 036 70 3NG	Dark brown			
	901 552 036 70 3AG	Blue	-79		
	901 552 036 70 8AT	Light red	-79		
	901 552 036 70 1AJ	Black	80-82		
	901 552 036 70 30B	Dark blue	80-82		
	901 552 036 70 30A	Blue	80		
	901 552 036 70 40D	Cork	80		
	901 552 036 70 60S	Hannibal grey	81-		
	901 552 036 70 20S	Mint green	81-		
	901 552 036 70 6AD	Doric grey	80		

Model: 911 78 Model life 1978>>1983

Pos	Part Number	Description	Remark	Qty	Model
	901 552 036 70 2LB	Burgundy			
	901 552 036 70 LG7	Burgundy	83-		
	901 552 036 70 LG6	Dark green	83-		
	901 552 036 70 KZ2	Black	83-		
	901 552 036 70 KZ3	Blue	83-		
	901 552 036 70 KZ5	Brown	83-		
22	901 552 050 25	Ashtray handle		1	SC
		Leatherette			
	901 552 050 25 7AE	Black			
	901 552 050 25 8AE	Lobster	-78		
	901 552 050 25 5AE	Cork			
	901 552 050 25 21S	Brown	79-82		
	901 552 050 25 30B	Dark blue	80-		
	901 552 050 25 3MX	Burgundy	83-		
	901 552 050 25 4RB	Brown	83-		
	901 552 050 25 503	Brown-beige			
22	911 552 050 70	Ashtray handle		1	
		Leather			
	911 552 050 70 7AG	Black	-79		
	911 552 050 70 8AH	Lobster	-78		
	911 552 050 70 5AH	Cork	-79		
	911 552 050 70 20B	Dark green			
	911 552 050 70 3NG	Dark brown			
	911 552 050 70 3AG	Blue	-79		
	911 552 050 70 8AT	Light red	-79		
	911 552 050 70 1AJ	Black	80-82		
	911 552 050 70 30B	Dark blue	80-82		
	911 552 050 70 30A	Blue	80		
	911 552 050 70 40D	Cork	80		
	911 552 050 70 60S	Hannibal grey	81-		
	911 552 050 70 20S	Mint green	81-		
	911 552 050 70 6AD	Doric grey	80		
	911 552 050 70 2LB	Burgundy			
	911 552 050 70 LG7	Burgundy	83-		
	911 552 050 70 LG6	Dark green	83-		
	911 552 050 70 KZ2	Black	83-		
	911 552 050 70 KZ3	Blue	83-		
	911 552 050 70 KZ5	Brown	83-		
23	901 552 061 25	Ashtray		1	
24	901 552 607 00	Fireproof plate		1	
25	N 011 005 14	Hexagon nut		4	
		M 5			
25	900 076 091 01	Hexagon nut		4	
		M 5			
26	N 011 665 3	Washer		4	
		5,3			
26	N 011 665 16	Washer		4	
		5,3			
27	N 011 005 14	Hexagon nut		2	
		M 5			
27	900 076 091 01	Hexagon nut		2	
		M 5			
28	N 011 665 3	Washer		2	
		5,3			
28	N 011 665 16	Washer		2	
		5,3			
29	900 070 001 02	Cap nut		2	
		M 4			
30	N 012 224 3	Spring washer		2	
		B 4			

Model: 911 78

Model life 1978>>1983

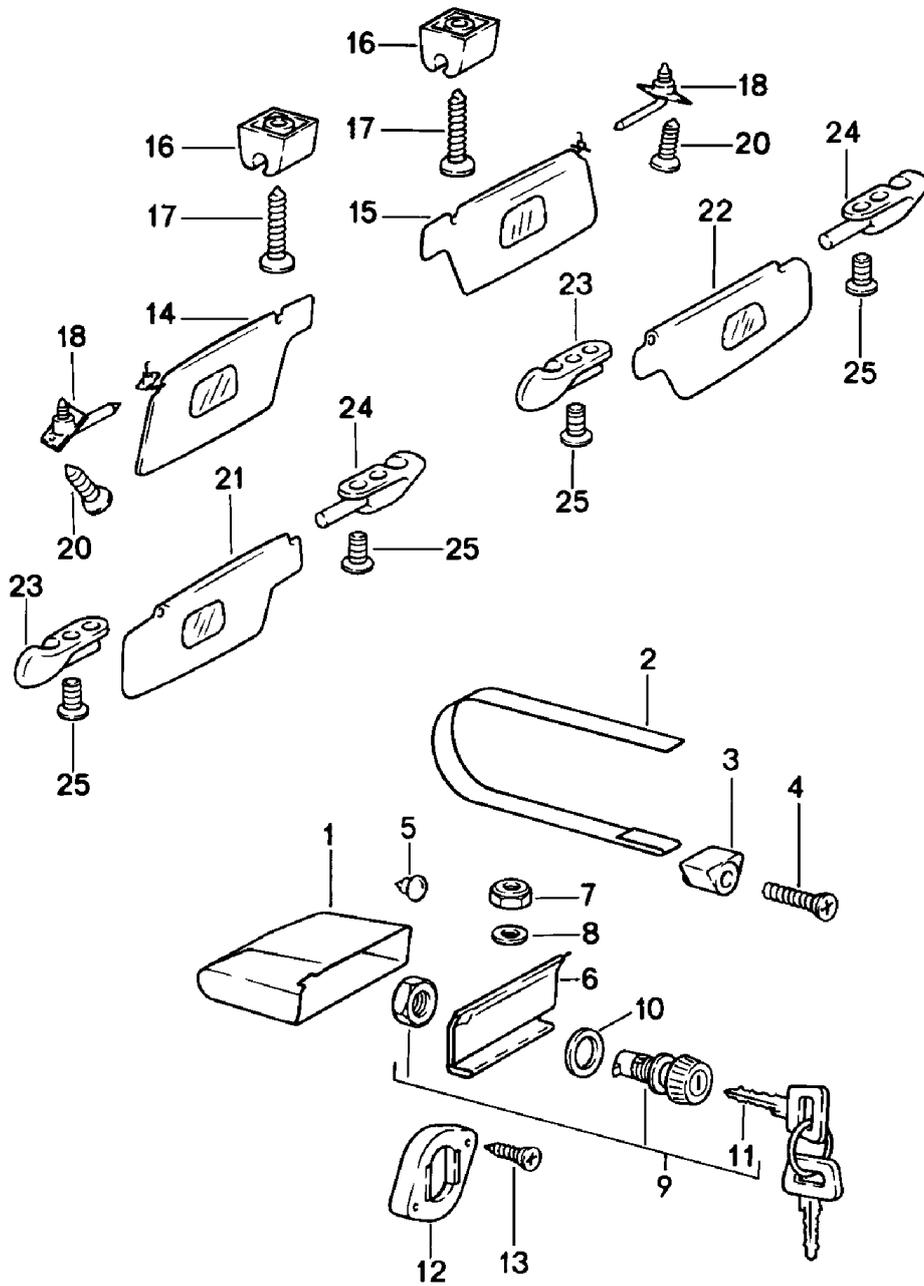

Model: 911 78 Model life 1978>>1983

Pos	Part Number	Description	Remark	Qty	Model
		Glove compartment			
		Sun visors			
1	911 552 501 00	Glove compartment		1	
2	901 552 531 20	Restraining strap		1	
(3)	911 552 176 01	Restraining strap	/LL	1	
3	911 552 075 00	Threaded piece	/RL	1	
4	900 146 010 02	Oval-head screw AM 5 X 30		1	
5	999 703 064 50	Buffer 14 X 12		2	
(5)	999 703 330 50	Buffer 14 X 17,5		X	
6	911 552 010 04	Glove compartment cover		1	
7	N 021 196 1	Lock nut M 5		4	
7	N 021 196 3	Hexagon nut M 5		4	
8	900 025 003 02	Washer 5,3		4	
9	911 552 902 07	Glove compartment lock		1	
9		Glove compartment lock W/o stipulated lock number		1	
9	911 552 902 08	Glove compartment lock State lock number		1	
10	911 552 103 01	Washer		1	
(11)	911 538 903 00	Blank key		2	
(11)		Blank key		2	
(11)	944 538 041 00	Key lamp		2	
(11)	944 538 041 01	Key lamp		2	
(11)	911 538 902 00	Replacement key State lock number Information available		2	
12	911 552 513 02	Door lock striker		1	
13	900 143 065 07	Tapping screw 2,9 X 9,5		2	
13	900 073 003 01	Tapping screw 2,9 X 9,5		2	
(14)	911 731 031 17	Sun visor without mirror	/LL /L	1	COUPE
	911 731 031 17 CA9	Black			
	911 731 031 17 2LB	Burgundy			
	911 731 031 17 40A	Brown	-82		
	911 731 031 17 JQ5	Burgundy	83		
	911 731 031 17 CC4	White/black			
	911 731 031 17 CC1	Blue			
	911 731 031 17 LA7	Brown	83		
(14)	964 731 031 01	Sun visor with mirror	/LL /L	1	COUPE
	964 731 031 01 CA9	Black			
(14)	964 731 031 00	Sun visor with mirror	/LL /L	1	COUPE
	964 731 031 00 CA9	Black			
(14)	911 731 031 04	Sun visor without mirror	/L (AUS)	1	COUPE
	911 731 031 04 CA9	Black			
	911 731 031 04 40A	Brown	-82		
	911 731 031 04 JQ5	Burgundy	83-		
	911 731 031 04 KH8	Grey-beige	83-		
	911 731 031 04 CC4	White/black			
	911 731 031 04 CC1	Blue			
	911 731 031 04 LA7	Brown	83-		
14	911 731 031 18	Sun visor with mirror	/RL /L	1	COUPE

Model: 911 78 Model life 1978>>1983

Pos	Part Number	Description	Remark	Qty	Model
	911 731 031 18 CA9	Black			
	911 731 031 18 2LB	Burgundy			
	911 731 031 18 40A	Brown	-82		
	911 731 031 18 JQ5	Burgundy	83-		
	911 731 031 18 CC4	White/black			
	911 731 031 18 CC1	Blue			
	911 731 031 18 LA7	Brown	83-		
14	964 731 031 01	Sun visor	/RL /L	1	COUPE
	964 731 031 01 CA9	with mirror			
		Black			
14	964 731 031 00	Sun visor	/RL /L	1	COUPE
	964 731 031 00 CA9	with mirror			
		Black			
15	911 731 032 17	Sun visor	/LL /R	1	COUPE
		with mirror			
	911 731 032 17 CA9	Black			
	911 731 032 17 2LB	Burgundy			
	911 731 032 17 40A	Brown	-82		
	911 731 032 17 JQ5	Burgundy	83-		
	911 731 032 17 CC4	White/black			
	911 731 032 17 CC1	Blue			
	911 731 032 17 LA7	Brown	83-		
15	964 731 032 00	Sun visor	/LL /R	1	COUPE
	964 731 032 00 CA9	with mirror			
		Black			
(15)	911 731 032 04	Sun visor	/R (AUS)	1	COUPE
		without mirror			
	911 731 032 04 CA9	Black			
	911 731 032 04 40A	Brown	-82		
	911 731 032 04 JQ5	Burgundy	83-		
	911 731 032 04 KH8	Grey-beige	83-		
	911 731 032 04 CC4	White/black			
	911 731 032 04 CC1	Blue			
	911 731 032 04 LA7	Brown	83-		
(15)	911 731 032 18	Sun visor	/RL /R	1	COUPE
		without mirror			
	911 731 032 18 CA9	Black			
	911 731 032 18 2LB	Burgundy			
	911 731 032 18 40A	Brown	-82		
	911 731 032 18 JQ5	Burgundy	83-		
	911 731 032 18 CC4	White/black			
	911 731 032 18 CC1	Blue			
	911 731 032 18 LA7	Brown	83-		
16	911 731 331 00	Support	(AUS)	2	COUPE
(16)		Support		2	COUPE
17	900 143 111 07	Oval-head sheetmetal screw		2	COUPE
		B 3,9 X 13			
18	964 731 319 00	Bearing		2	COUPE
20	900 145 075 07	Tapping screw		4	COUPE
		B 4,2 X 16			
(21)	911 731 031 60	Sun visor	/L	1	TARGA
		without mirror			
		Black			
(21)	911 731 031 61	Sun visor	/L	1	TARGA/CABRIO
		with mirror			
		Black			
(22)	911 731 032 60	Sun visor	/R	1	TARGA/CABRIO
		with mirror			
		Black			
(22)	911 731 032 53	Sun visor	/RL /R -82	1	TARGA
		without mirror			
		Black			
(22)	911 731 032 61	Sun visor	/R	1	TARGA

Model: 911 78

Model life 1978>>1983

Pos	Part Number	Description	Remark	Qty	Model
		without mirror Black			
23	911 731 323 41	Bearing bracket	/L	2	TARGA
(23)	964 731 319 40	Bearing bracket	/L (AUS)	2	TARGA
(23)		Bearing bracket	/L	2	CABRIO
24	911 731 324 41	Bearing bracket	/R	2	TARGA
(24)	964 731 320 40	Bearing bracket	/R (AUS)	2	TARGA
(24)		Bearing bracket	/R	2	CABRIO
25	900 145 075 07	Tapping screw 4,2 X 16		4	TARGA CABRIO

Model: 911 78

Model life 1978>>1983

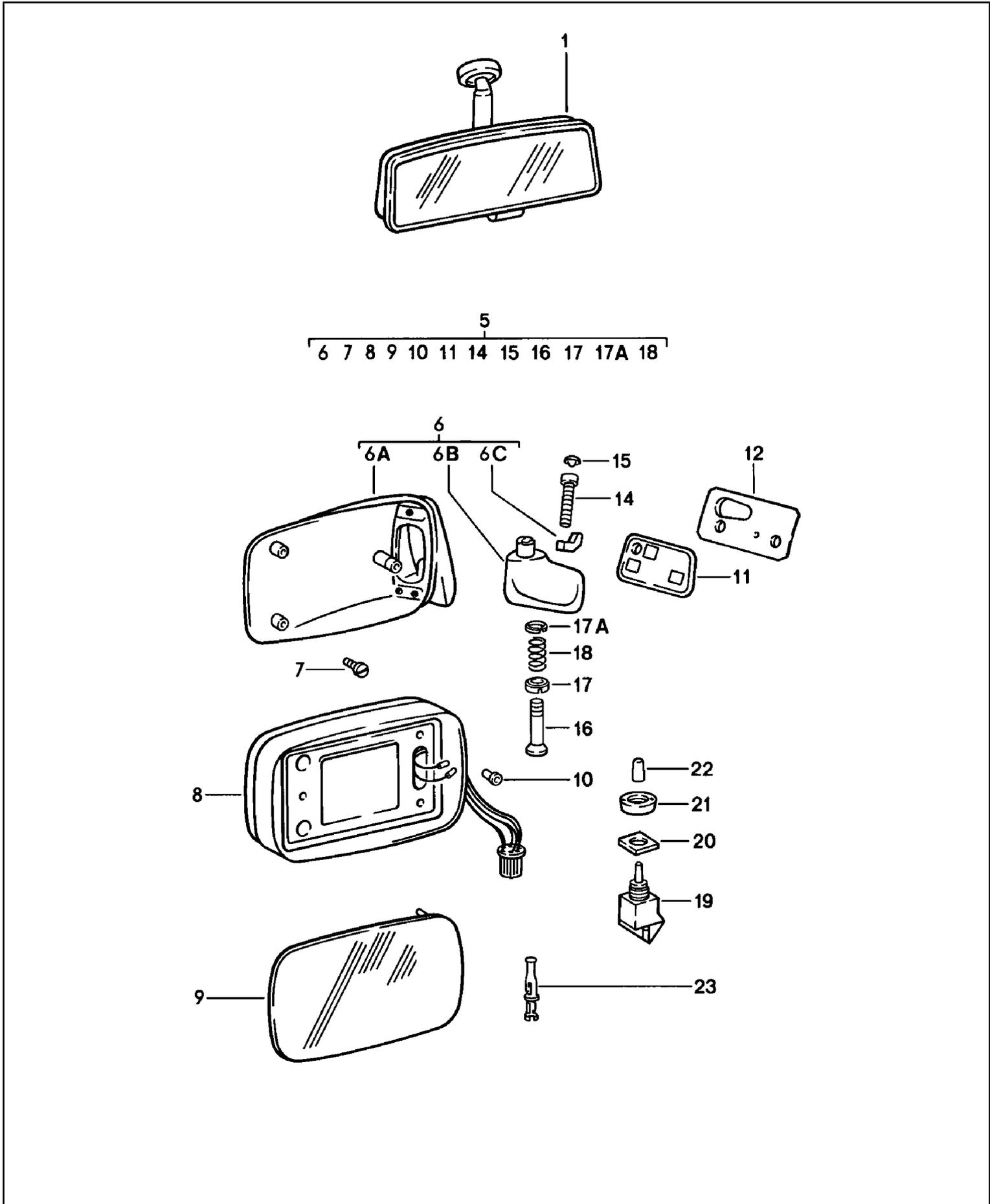

Model: 911 78 Model life 1978>>1983

Pos	Part Number	Description	Remark	Qty	Model
1	477 857 511 A	Rear-view mirror		1	
	477 857 511 A 01C	Door mirror			
		Interior mirror			
1	477 857 511 B	Satin black		1	
	477 857 511 B 01C	Interior mirror			
		Satin black			
-	911 731 901 01	Installation set	/LL /R	1	
		Door mirror			
		for subsequent installation			
		Order also:			
-	911 612 165 01	Wiring harness		1	
-	911 612 164 03	Wiring harness		1	
		POS.9			
		See TPI			
		NR.22			
5	911 731 927 00	Door mirror	/LL /L	1	
		Plane			
5	911 731 928 00	Door mirror	/LL /R	1	
		Plane			
5	911 731 929 00	Door mirror	/LL /L	1	
		Convex			
5	911 731 930 00	Door mirror	/LL /R	1	
		Convex			
5	911 731 931 00	Door mirror	/RL /L	1	
		Plane			
5	911 731 932 00	Door mirror	/RL /R	1	
		Plane			
5	911 731 933 00	Door mirror	/RL /L	1	
		Convex			
(5)		See TPI			
		NR.22			
(5)	911 731 927 01	Repair kit	/LL /L	1	
		Door mirror			
(5)	911 731 928 01	Repair kit	/LL /R	1	
		Door mirror			
(5)	911 731 931 01	Repair kit	/RL /L	1	
		Door mirror			
(5)	911 731 932 01	Repair kit	/RL /R	1	
		Order also:			
		Position			
		8- 10			
6A	911 731 043 03	Mirror housing	/L	1	
(6A)	911 731 044 03	Mirror housing	/R	1	
6B	911 731 241 02	Mirror base	/LL /L	1	
(6B)	911 731 287 02	Mirror base	/RL /L	1	
(6B)		Mirror base	/RL /L	1	
(6B)	911 731 288 02	Mirror base	/LL /R	1	
(6B)		Mirror base	/LL /R	1	
(6B)	911 731 242 02	Mirror base	/RL /R	1	
6AB	944 731 021 01	Mirror housing	/L	1	
	944 731 021 01 G3M	with			
		Mirror base			
		Grey			
		Prime coated			
6C	911 731 263 00	Mounting piece		2	
7	999 143 003 02	Hexagon-head bolt		3	
		M 5 X 10			
8	911 731 027 06	Covering frame	/L	1	
(8)	911 731 028 06	Covering frame	/R	1	
		Repair kit			
		for			
		Covering frame			
		Bayonet lock			

Model: 911 78 Model life 1978>>1983

Pos	Part Number	Description	Remark	Qty	Model
-	PCG 731 028 06	Comprising: Electronic unit Engine	/R /L	1	
-	944 731 027 01	Door mirror Covering frame	/R /L	1	
9	944 731 035 02	Use also: Mirror glass Bayonet lock		1	
9	944 731 035 04	Mirror glass Plane Bayonet lock	(S)	1	
9	944 731 035 03	Mirror glass Convex Bayonet lock		1	
9	944 731 035 05	Mirror glass Convex Bayonet lock	(S)	1	
9	911 731 035 08	Mirror glass Plane		1	
(9)	911 731 035 09	Mirror glass	(J) (N) (S)	1	
(9)		Mirror glass Convex	(J) (N) (S)	1	
10	999 703 128 40	Grommet		3	
11	911 731 247 00	Desk pad	/L	1	
(11)	911 731 248 00	Desk pad	/R	1	
12	911 531 197 00	Reinforcement	/L	1	
(12)	911 531 198 00	Reinforcement	/R	1	
14	999 218 021 02	Pan-head screw Micro-self-locking M 5 X 35		1	
14	999 218 021 0C	Pan-head screw Micro-self-locking M 5 X 35		1	
15	999 703 137 40	Cap		1	
16	911 731 257 02	Guide tube		1	
16	911 731 257 03	Guide tube		1	
16	911 731 257 02	Guide tube		1	
16	911 731 257 03	Guide tube		1	
17	911 731 345 02	Centring washer Lower		1	
17A	911 731 347 00	Centring washer Upper		1	
18	911 731 029 01	Compression spring		1	
19	911 613 115 00	Switch		1	
20	911 731 343 03	Gasket		1	
21	911 731 251 00	Round nut		1	
22	911 613 633 01	Protection cap		1	
-	477 957 861	Rubber sleeve Wheel housing		1	
-	803 971 979	Plug socket 7-pole		1	
23	N 017 562 4	Cylindrical socket 1,6 X 0,75		X	
-	111 971 958	Flat receptacle 2,8 X 8 Electric line		6	
-	911 612 163 01	Door mirror Wiring harness Driver's door		1	
-	911 612 163 02	Wiring harness Driver's door with Alarm system	/LL	1	

Model: 911 78 Model life 1978>>1983

Pos	Part Number	Description	Remark	Qty	Model
-	911 731 317 00	- BEIFÄHRERTÜR- without Spiegel Seal Connector		1	
-	911 612 162 03	Wiring harness FRONT luggage compartment	/LL	1	
-	911 612 162 02	Wiring harness FRONT luggage compartment	/RL	1	
-	911 612 890 00	Plug socket 3-pole Electric line		1	
-	911 612 165 01	Door mirror Wiring harness Driver's side		2 1	
-	911 612 166 01	Wiring harness Passenger's side		1	
-	911 612 160 60	Wiring harness Passenger's side Relay Heating	/LL	1	CABRIO
-	911 612 160 61	Wiring harness Relay Heating Passenger's side	/RL	1	CABRIO
-	911 612 164 03	Wiring harness FRONT luggage compartment	/LL	1	
-	911 612 164 02	Wiring harness FRONT luggage compartment	/RL	1	
-	803 971 980	Pin connector socket 7-pole		2	

Model: 911 78

Model life 1978>>1983

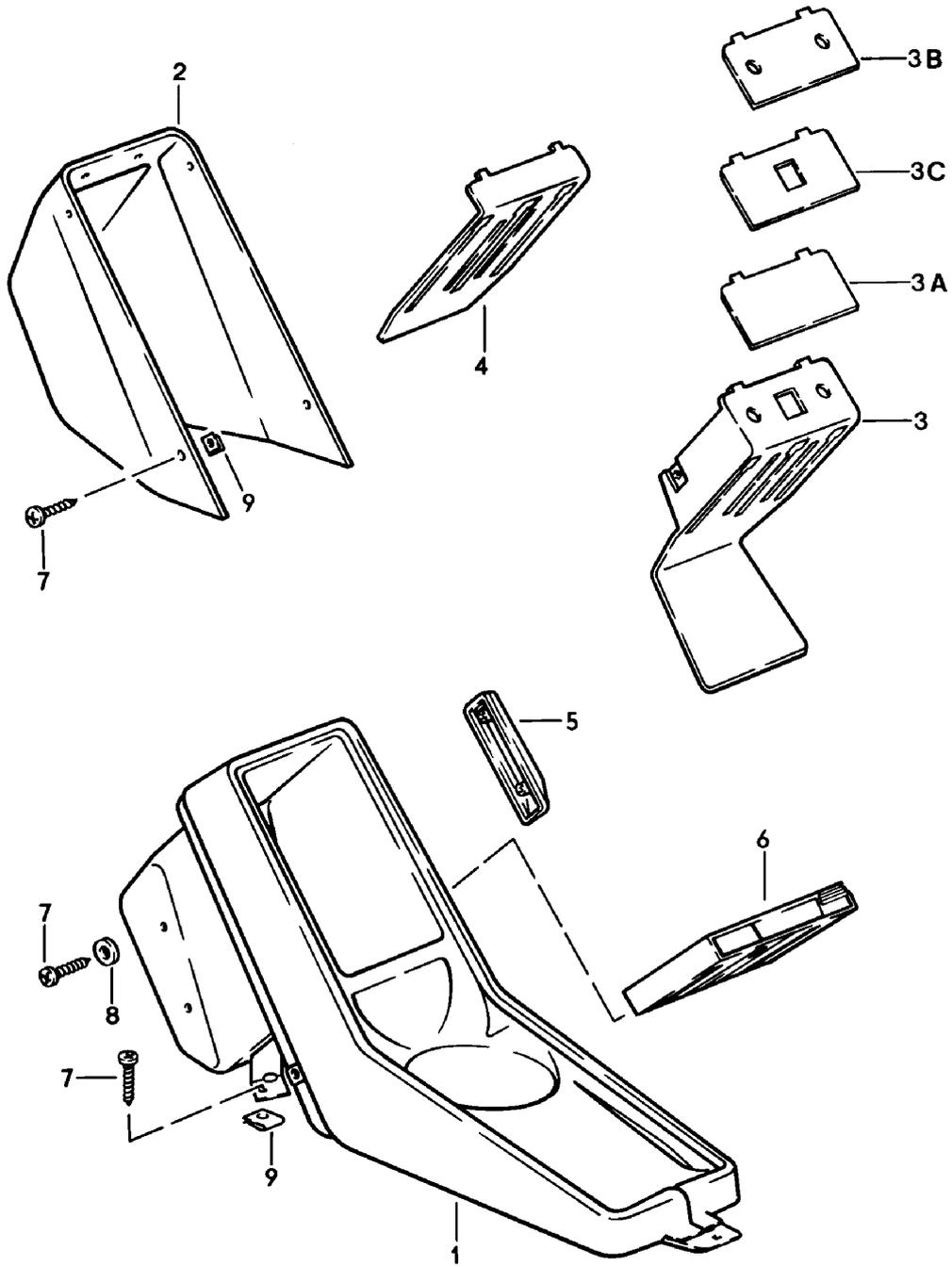

Model: 911 78 Model life 1978>>1983

Pos	Part Number	Description	Remark	Qty	Model
1	911 552 036 00	Centre console Centre console Leatherette		1	SC
	911 552 036 00 7AU	Black	-82		
	911 552 036 00 8AU	Lobster	-78		
	911 552 036 00 5AU	Cork	-79		
	911 552 036 00 4AU	Brown	79-82		
	911 552 036 00 3AU	Dark blue	80-82		
	911 552 036 00 5BC	Beige	80		
	911 552 036 00 3MK	Burgundy	83-		
	911 552 036 00 05T	Black	83-		
	911 552 036 00 1HH	Blue	83-		
	911 552 036 00 4RB	Brown	83-		
1	911 552 030 03	Centre console Leatherette		1	SC
	911 552 030 03 7AU	Black	-82		
	911 552 030 03 8AU	Lobster	-78		
	911 552 030 03 5AU	Cork	-79		
	911 552 030 03 4AU	Brown	79-82		
	911 552 030 03 3AU	Dark blue	80-82		
	911 552 030 03 5BC	Beige	80		
	911 552 030 03 3MK	Burgundy	83-		
	911 552 030 03 05T	Black	83-		
	911 552 030 03 1HH	Blue	83-		
	911 552 030 03 4RB	Brown	83-		
(1)	911 552 030 50	Centre console Leather		1	
	911 552 030 50 7AG	Black	-79		
	911 552 030 50 8AH	Lobster	-78		
	911 552 030 50 5AH	Cork	-79		
	911 552 030 50 20B	Dark green			
	911 552 030 50 2AP	Light green	-78		
	911 552 030 50 3NG	Brown	-82		
	911 552 030 50 3AG	Blue	-79		
	911 552 030 50 8AT	Light red	-79		
	911 552 030 50 1AG	Yellow	-79		
	911 552 030 50 9AG	White	-79		
	911 552 030 50 1AJ	Black	80-82		
	911 552 030 50 30B	Dark blue	80-82		
	911 552 030 50 50B	Beige	80-82		
	911 552 030 50 30A	Blue	80		
	911 552 030 50 80B	Light red	80		
	911 552 030 50 40D	Cork	80		
	911 552 030 50 10A	Yellow	80		
	911 552 030 50 99A	White	80		
	911 552 030 50 80S	Can-can-red	81-82		
	911 552 030 50 95S	Papyrus	81-82		
	911 552 030 50 60S	Hannibal grey	81-82		
	911 552 030 50 20S	Mint green	81-82		
	911 552 030 50 6AD	Doric grey	80		
	911 552 030 50 2LB	Burgundy			
	911 552 030 50 LG7	Burgundy	83-		
	911 552 030 50 LG6	Dark green	83-		
	911 552 030 50 KZ2	Black	83-		
	911 552 030 50 KZ3	Blue	83-		
	911 552 030 50 KZ5	Brown	83-		
2	911 552 231 00	Cap		1	
(3)	911 552 169 00	Cassette carrier Order also:		1	
-	911 613 243 00	Blower switch		1	
-	911 613 119 02	Rosette		1	
-	999 591 619 01	Knob holder		1	
3A	911 552 273 00	Adhesive film		1	

Model: 911 78

Model life 1978>>1983

Pos	Part Number	Description	Remark	Qty	Model
3B	911 552 269 00	Cover Air-conditioning switch		1	
3C	911 552 271 00	Cover Fader		1	
4	911 552 259 01	Cover		1	
5	911 552 177 01	Stop		1	
6	911 645 226 00	Cassette box		X	
6	964 552 753 00	Cassette box		X	
	964 552 753 00 01C	Black			
7	900 143 007 02	Oval-head sheetmetal screw 4,2 X 13		9	
7	900 073 507 01	Oval-head sheetmetal screw 4,2 X 13		9	
8	900 025 003 02	Washer A 5,3		2	
9	999 507 240 00	Speed nut B 4,2		7	

Model: 911 78

Model life 1978>>1983

4—*Turbo*

5—⊙

6—**SRS** SC

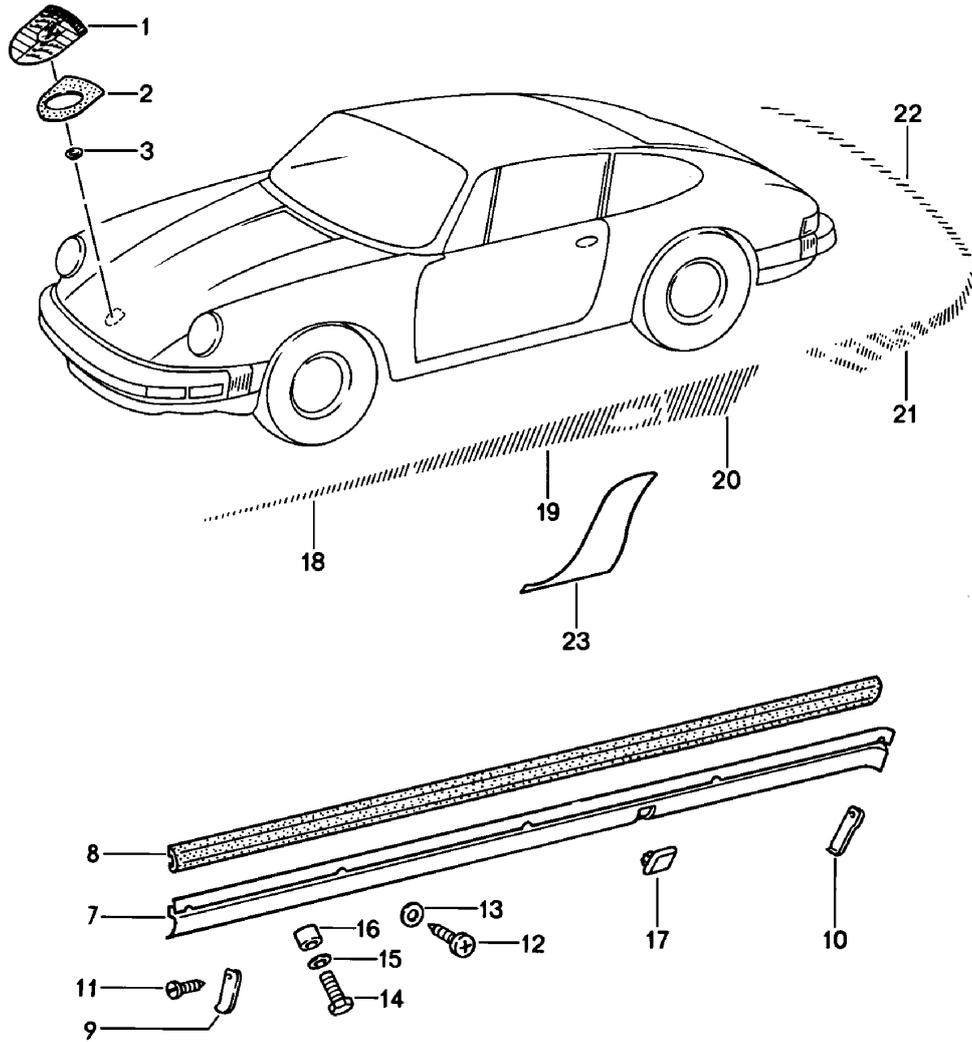

Model: 911 78 Model life 1978>>1983

Pos	Part Number	Description	Remark	Qty	Model
		Decorative fittings			
1	901 559 210 20	Lid emblem		1	
1	901 559 210 26	Lid emblem		1	
2	901 559 215 20	Desk pad		1	
2	7L5 853 611 B	Desk pad		1	
3	999 591 423 03	Tapping nut		2	
4	930 559 317 00	Logo		1	TURBO
4	930 559 317 03	Logo		1	TURBO
5	999 591 423 03	Tapping nut		X	
6	911 559 337 00	Logo		1	911 SC
6	911 559 337 01	Logo		1	911 SC
7	911 559 047 01	Trim cover	/L	1	SC
7		Trim cover	/L	1	SC
	911 559 047 01 GRV	Prime coated			
(7)	930 559 047 01	Trim cover	/L	1	TURBO
(7)		Trim cover	/L	1	TURBO
	930 559 047 01 GRV	Prime coated			
(7)	911 559 048 01	Trim cover	/R	1	SC
(7)		Trim cover	/R	1	SC
	911 559 048 01 GRV	Prime coated			
(7)	930 559 048 01	Trim cover	/R	1	TURBO
(7)		Trim cover	/R	1	TURBO
	930 559 048 01 GRV	Prime coated			
8	930 559 103 01	Rubber moulding		2	SC
(8)		Rubber moulding		2	TURBO
9	911 559 141 04	End piece	/V /R	2	
			/H /L		
10	911 559 142 04	End piece	/V /L	2	
			/H /R		
11	900 143 049 07	Tapping screw BZ 3,5 X 9,5		8	
12	900 143 031 02	Oval-head sheetmetal screw B 4,2 X 9,5		10	
13	900 025 002 02	Washer 4,3		10	
13	900 025 002 03	Washer 4,3		10	
14	900 187 032 02	Tapping screw B 6,3 X 32		6	
15	900 151 007 02	Washer 7,4		6	
15	900 151 007 03	Washer 7,4		6	
16	911 559 145 00	Spacer sleeve 11,8		3	
16	911 559 145 01	Spacer sleeve 5,5		3	
17	911 559 149 01	Stopper Adhesive film Black Hatched		2	
18	930 559 301 00	Adhesive film	/L	1	
(18)	930 559 302 00	Adhesive film	/R	1	
19	930 559 303 00	Adhesive film	/L	1	
(19)	930 559 304 00	Adhesive film	/R	1	
20	930 559 305 00	Adhesive film	/L	1	
(20)	930 559 306 00	Adhesive film	/R	1	
21	930 559 307 00	Adhesive film	/L	1	
(21)	930 559 308 00	Adhesive film	/R	1	
22	930 559 309 00	Adhesive film White Hatched		1	

Model: 911 78 Model life 1978>>1983

Pos	Part Number	Description	Remark	Qty	Model
(18)	930 559 301 01	Adhesive film	/L	1	
(18)	930 559 302 01	Adhesive film	/R	1	
(19)	930 559 303 01	Adhesive film	/L	1	
(19)	930 559 304 01	Adhesive film	/R	1	
(20)	930 559 305 01	Adhesive film	/L	1	
(20)	930 559 306 01	Adhesive film	/R	1	
(21)	930 559 307 01	Adhesive film	/L	1	
(21)	930 559 308 01	Adhesive film	/R	1	
(22)	930 559 309 01	Adhesive film		1	
		Lateral stripes Martini			
18-22	911 559 017 00	Adhesive film 1 set	-78	1	SC
(18)	911 559 351 00	Adhesive film	/L -78	1	SC
(18)	911 559 352 00	Adhesive film	/R -78	1	SC
(19)	911 559 353 00	Adhesive film	/L -78	1	SC
(19)	911 559 354 00	Adhesive film	/R -78	1	SC
(20)	911 559 355 00	Adhesive film	/L -78	1	SC
(20)	911 559 356 00	Adhesive film	/R -78	1	SC
(21)	911 559 357 00	Adhesive film	/L -78	1	SC
(21)	911 559 358 00	Adhesive film	/R -78	1	SC
(22)	911 559 359 00	Adhesive film	-78	1	SC
		Lateral stripes Martini			
18-22	930 559 017 00	Adhesive film 1 set	-78	1	TURBO
(18)	930 559 351 00	Adhesive film	/L -78	1	TURBO
(18)	930 559 352 00	Adhesive film	/R -78	1	TURBO
(19)	930 559 353 00	Adhesive film	/L -78	1	TURBO
(19)	930 559 354 00	Adhesive film	/R -78	1	TURBO
(20)	930 559 355 00	Adhesive film	/L -78	1	TURBO
(20)	930 559 356 00	Adhesive film	/R -78	1	TURBO
(21)	930 559 357 00	Adhesive film	/L -78	1	TURBO
(21)	930 559 358 00	Adhesive film	/R -78	1	TURBO
(22)	930 559 359 00	Adhesive film	-78	1	TURBO
23	930 559 921 00	Stone guard film Set		1	TURBO
23	930 559 321 00	Stone guard film	/L	1	TURBO
(23)	930 559 322 00	Stone guard film	/R	1	TURBO

Model: 911 78

Model life 1978>>1983

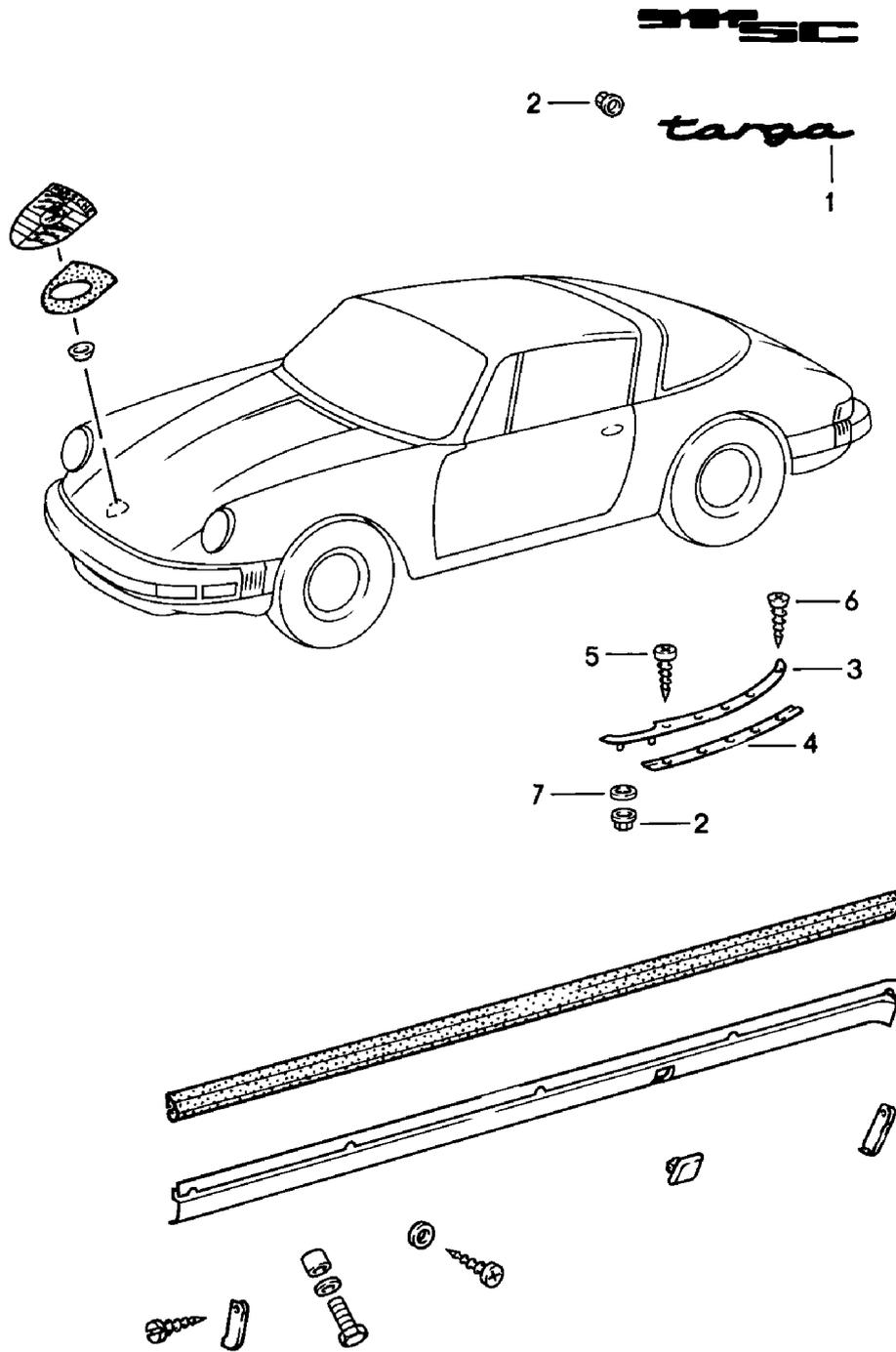

Model: 911 78

Model life 1978>>1983

Pos	Part Number	Description	Remark	Qty	Model
		Decorative fittings			
1	911 559 307 41	Logo		2	TARGA
1	911 559 307 42	Logo		2	TARGA
2	999 591 423 03	Tapping nut		6	TARGA
3	911 565 947 40	Moulding Chrome	/L -79	1	
(3)	911 565 049 40	Moulding	/L	1	
	911 565 049 40 70K	Black			
(3)	911 565 948 40	Moulding Chrome	/R -79	1	
(3)	911 565 050 40	Moulding	/R	1	
	911 565 050 40 70K	Black			
4	901 565 557 40	Piping		2	
5	N 013 957 5	Oval-head sheetmetal screw B 3,5 X 9,5		8	
6	900 144 009 00	Counters. head tapp. screw 2,9 X 13		2	
7	900 151 006 40	Washer B 6,4		4	

Model: 911 78

Model life 1978>>1983

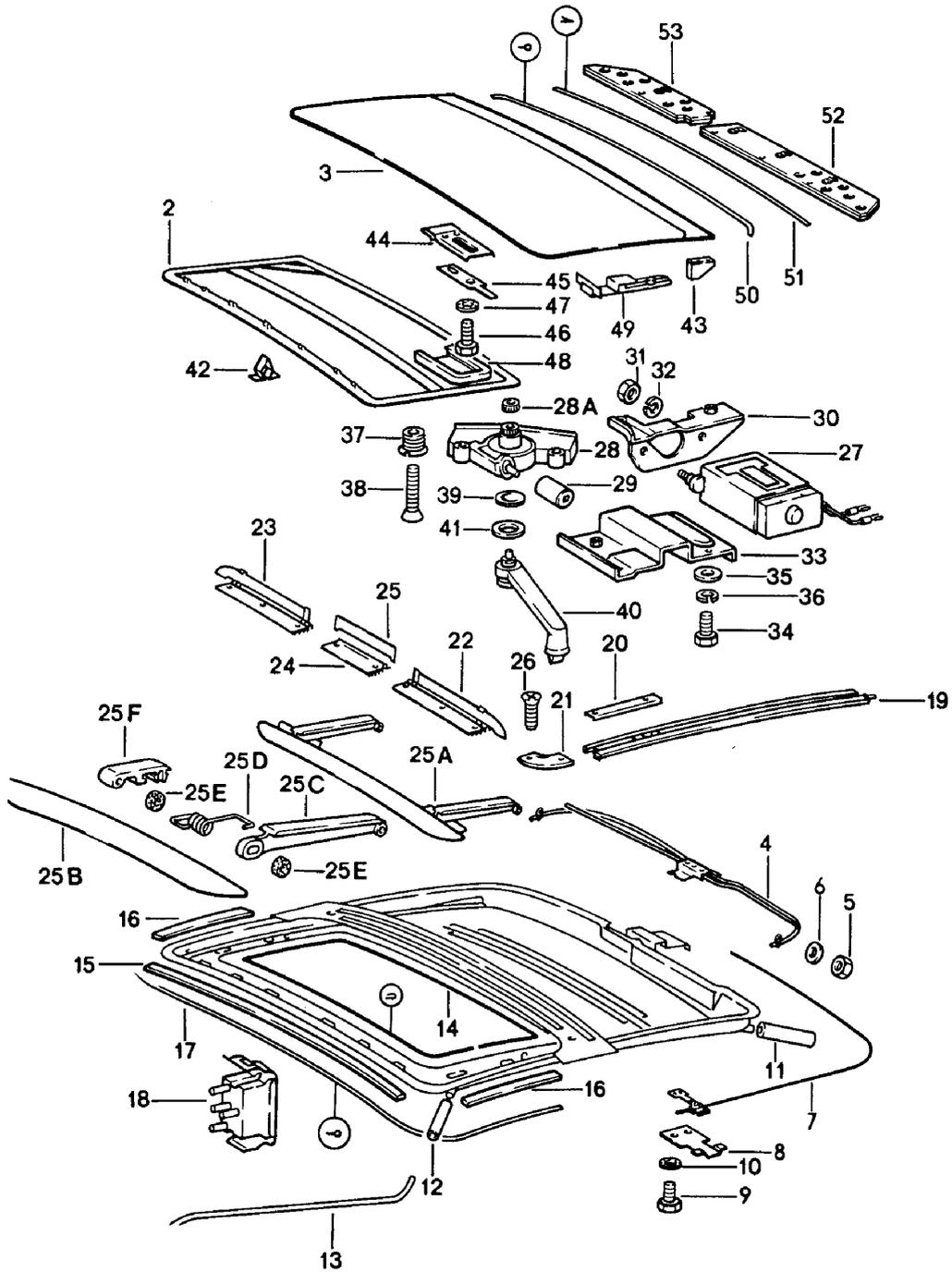

Model: 911 78 Model life 1978>>1983

Pos	Part Number	Description	Remark	Qty	Model
2	911 564 020 00	Sunroof			
	911 564 020 00 500	Roofliner frame		1	
	911 564 020 00 700	Beige	-82		
	911 564 020 00 3AD	Black			
	911 564 020 00 21S	Dark blue	-82		
	911 564 020 00 2LB	Brown	-82		
	911 564 020 00 8LC	Burgundy			
	911 564 020 00 7FC	Burgundy	83-		
	911 564 020 00 1HH	Grey-beige	83-		
	911 564 020 00 4RB	Blue	83-		
	911 564 020 00 4RB	Brown	83-		
-	901 564 291 07	Roofliner frame		1	
	901 564 291 07 500	Roofliner frame			
	901 564 291 07 700	Beige	-82		
	901 564 291 07 3AD	Black			
	901 564 291 07 21S	Dark blue	-82		
	901 564 291 07 2LB	Brown	-82		
	901 564 291 07 8LC	Burgundy			
	901 564 291 07 7FC	Burgundy	83-		
	901 564 291 07 1HH	Grey-beige	83-		
	901 564 291 07 4RB	Blue	83-		
	901 564 291 07 4RB	Brown	83-		
3	930 564 051 01	Lid		1	
-	911 564 417 00	Leaf spring		2	
-	911 564 420 00	Knurled nut		4	
(4)	964 564 231 00	Pipeline		1	
5	N 011 005 14	Hexagon nut		2	
		M 5			
5	900 076 091 01	Hexagon nut		2	
		M 5			
6	900 025 003 02	Washer		2	
		A 5,3			
(7)	911 564 043 01	Guide	/L	1	
		It is necessary to rework			
(7)	911 564 044 01	Guide	/R	1	
		It is necessary to rework			
8	901 564 451 05	Reinforcement		2	
9	900 075 106 02	Hexagon-head bolt		4	
		M 4 X 6			
10	N 012 116 1	Serrated lock washer		4	
		A 4,3			
11	911 564 825 00	Water drain hose	/H	2	
12	911 564 821 01	Water drain hose	/V	2	
13	911 503 581 01	Water drain tube	/L	1	
(13)	911 503 582 01	Water drain tube	/R	1	
14	911 564 465 00	Beading		1	
15	911 564 409 00	Sealing strip		1	
		Front			
16	911 564 409 01	Sealing strip		2	
		Lateral			
17	911 564 191 00	Velvet strip		1	
18	911 613 622 00	Tip switch		1	
		for electric adjustment			
18	911 613 622 01	Tip switch		1	
		for electric adjustment			
19	901 564 041 05	Guide rail	/L -81	1	
(19)	911 564 041 00	Guide rail	/L 82	1	
(19)	911 564 041 01	Guide rail	/L 83-	1	
(19)	901 564 042 05	Guide rail	/R -81	1	
(19)	911 564 042 00	Guide rail	/R 82	1	
(19)	911 564 042 01	Guide rail	/R 83-	1	
20	901 564 407 05	Intermediate piece	-82	2	
20	911 564 047 00	Intermediate piece	83-	2	

Model: 911 78

Model life 1978>>1983

Pos	Part Number	Description	Remark	Qty	Model
21	901 564 405 05	Corner piece	/L -82	1	
(21)	901 564 406 05	Corner piece	/R -82	1	
22	901 564 073 05	Air deflector	/L -82	1	
		Cable cover			
23	901 564 074 05	Air deflector	/R -82	1	
		Cable cover			
24	901 564 409 05	Centre piece	-82	1	
25	901 564 703 05	Air deflector	-82	1	
		Centre			
25A	911 564 005 01	Air deflector	83-	1	
		without			
		Spoiler			
25A	911 564 005 02	Air deflector	83-	1	
		without			
		Spoiler			
25B	911 564 015 00	Wind deflector plate	83-	1	
25C	911 564 127 00	Hinge	83-	2	
25D	911 564 125 00	Spring	/L 83-	1	
(25D)	911 564 126 00	Spring	/R 83-	1	
25E	911 564 423 00	Rubber stop	83-	4	
25F	911 564 123 00	Bearing clip	83-	2	
26	900 145 009 02	Tapping screw		16	
		B 3,9 X 9,5			
27	911 624 016 03	Motor		1	
28	911 564 601 01	Transmission		1	
28A	928 564 125 02	Drive pinion		1	
29	911 624 103 00	Clutch		1	
29	911 624 103 01	Clutch		1	
30	911 624 007 01	Engine support		1	
31	N 011 005 14	Hexagon nut		2	
		M 5			
31	900 076 091 01	Hexagon nut		2	
		M 5			
32	N 012 005 3	Lock ring		2	
		B 5			
33	964 564 035 00	Gear support		1	
34	900 075 001 03	Hexagon-head bolt		1	
		M 5 X 8			
35	900 025 003 02	Washer		2	
		A 5,3			
36	N 012 005 3	Lock ring		2	
		B 5			
37	901 564 661 05	Screw		2	
38	900 269 012 02	Countersunk-head screw		2	
		M 4 X 25			
39	901 564 663 05	Cap		1	
40	901 564 085 05	Crank		1	
41	911 564 643 00	Washer		3	
42	901 564 299 05	Duct clamp		7	
42	901 564 299 0F	Duct clamp		7	
43	901 564 431 05	Guide shoe		2	
44	911 564 045 00	Guide		2	
45	911 564 451 00	Tab washer		2	
46	911 564 459 00	Wedge screw		4	
		AM 5 X 12			
47	900 025 003 02	Washer		4	
		A 5,3			
48	911 564 401 00	Cap/protective strip		2	
(49)	901 564 433 05	Edge protection	-82	4	
49	911 564 433 00	Support	83-	4	
50	911 564 193 00	Velvet strip		1	
51	901 564 905 05	Sealing rubber		1	
		Rear			

Model: 911 78

Model life 1978>>1983

Pos	Part Number	Description	Remark	Qty	Model
52	911 564 025 01	Cover		1	
53	911 564 026 00	Cover		1	

Model: 911 78

Model life 1978>>1983

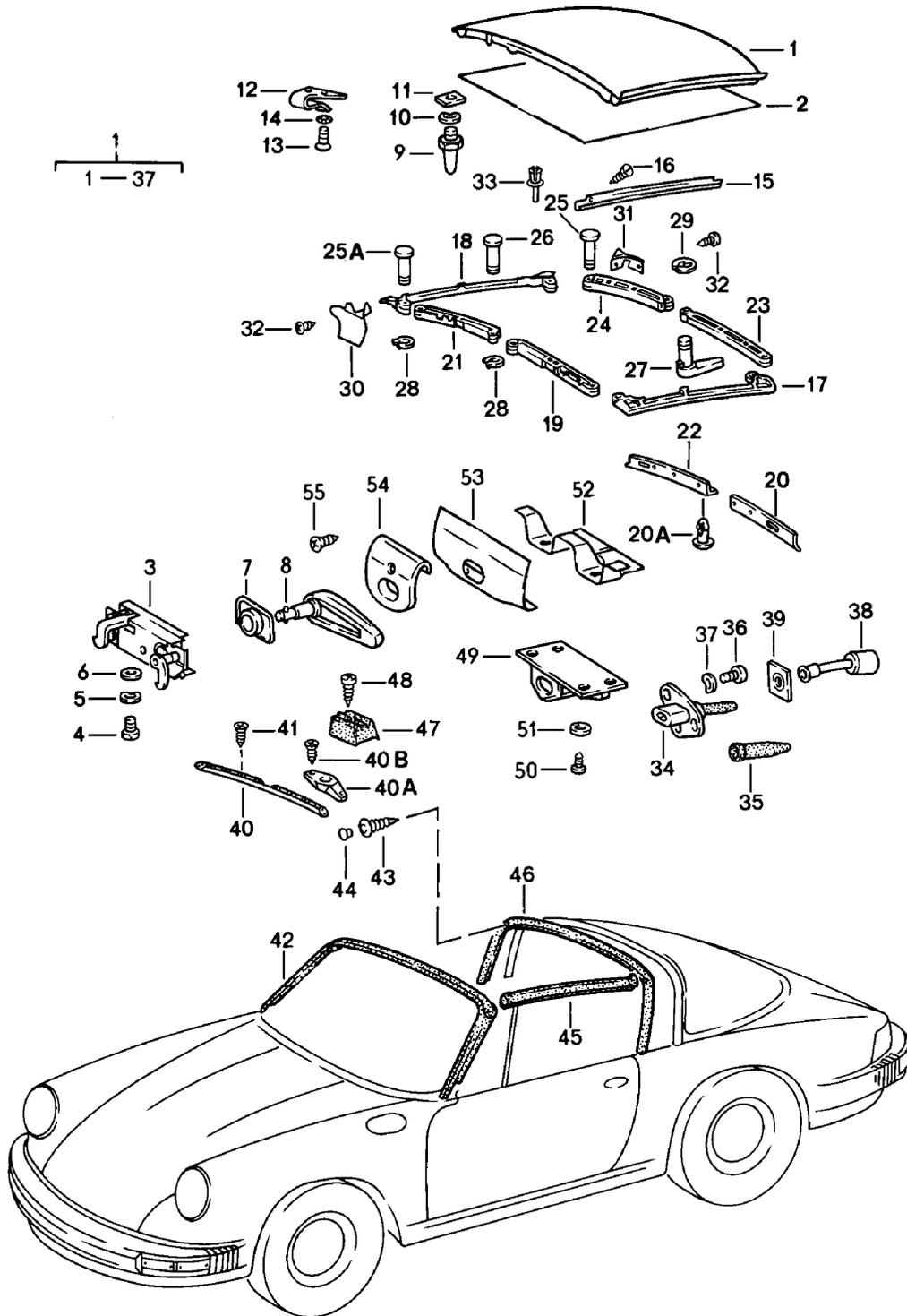

Model: 911 78 Model life 1978>>1983

Pos	Part Number	Description	Remark	Qty	Model
		Soft top			TARGA
1	911 565 002 40	Soft top		1	
-	901 565 035 41	Outer lining		1	
		Soft top			
2	901 565 036 43	Roofliner		1	
3	911 565 031 41	Catch	-81	2	
3		Catch		2	
4	999 509 006 02	Pan-head screw M 6 X 15	-81	4	
4	900 249 001 02	Countersunk-head screw M 6 X 15	82-	4	
4	900 249 031 01	Countersunk-head screw M 6 X 15	82-	4	
5	N 012 226 5	Spring washer B 6		4	
6	N 011 524 7	Washer A 6,4		4	
6	N 011 524 27	Washer A 6,4		4	
7	901 565 299 45	Rosette		2	
7	901 565 299 46	Rosette		2	
8	911 565 075 41	Handle		2	
9	911 565 074 40	Locating peg		2	
10	N 012 241 1	Spring washer		2	
11	901 565 203 40	Threaded plate		2	
12	964 565 265 00	Latch		8	
12	964 565 265 01	Latch		8	
13	999 219 006 02	Countersunk-head screw M 4 X 8		16	
14	900 115 008 02	Serrated lock washer V 4,3	-80	16	
15	901 565 303 45	Rain channel	/L	1	
(15)	901 565 304 45	Rain channel	/R	1	
16	900 143 049 07	Tapping screw BZ 3,5 X 9,5		10	
17	901 565 201 45	Roof frame Lateral	/L	1	
18	901 565 202 45	Roof frame Lateral	/R	1	
19	911 565 207 40	Roof frame Front	/L	1	
20	901 565 093 46	Padded cover	/L	1	
20A	999 703 114 40	Stopper		10	
21	911 565 208 40	Roof frame Front	/R	1	
22	901 565 094 46	Padded cover	/R	1	
23	901 565 211 45	Roof frame Rear	/L	1	
23		Roof frame Rear	/L	1	
		Left			
24	901 565 211 45 70B	Black			
	911 565 212 40	Roof frame Rear	/R	1	
25	901 565 328 45	Bolt		4	
26	901 565 209 40	Bolt		1	
27	964 565 145 00	Locking bolt		1	
28	900 041 004 01	Circlip		5	
29	900 116 007 01	Lock washer		1	
29	N 012 439 1	Lock washer		1	
29	N 012 439 2	Lock washer		1	
(30)	901 565 097 46	Lining	/V /L	1	
30	901 565 098 46	Lining	/V /R	1	

Model: 911 78

Model life 1978>>1983

Pos	Part Number	Description	Remark	Qty	Model
(31)	901 565 273 45	Cover	/H /L	1	
31	901 565 274 45	Cover	/H /R	1	
(31)	901 565 289 45	Cover strip Black	-82	2	
32	N 013 953 2	Oval-head sheetmetal screw B 2,9 X 9,5		12	
33	999 591 519 40	Expansion rivet		3	
34	911 565 037 42	Silentbloc bearing	/L	1	
(34)	911 565 038 42	Silentbloc bearing	/R	1	
35	911 565 217 40	Covering		2	
36	N 014 765 2	Pan-head screw M 6 X 10		6	
37	N 012 226 5	Spring washer B 6		6	
38	911 565 220 41	Silentbloc bearing		2	
38	911 565 220 42	Silentbloc bearing		2	
39	901 565 361 40	Seal		2	
40	911 555 559 41	Border strip Chrome	/L -82	1	
(40)	911 555 559 60	Border strip Black	/L	1	
(40)	911 555 560 41	Border strip Chrome	/R -82	1	
(40)	911 555 560 60	Border strip Black	/R	1	
40A	911 555 491 40	Guide rose	/L 83-	1	
(40A)	911 555 492 40	Guide rose	/R 83-	1	
40B	900 143 084 07	Oval-head sheetmetal screw B 3,5 X 16	83-	4	
41	900 145 036 00	Rais. counters. h. tap. s. B 3,5 X 13		8	
(41)	900 145 071 07	Tapping screw Black B 3,5 X 13		8	
42	911 565 090 47	Gasket		1	TARGA CABRIO
43	999 703 186 40	It is necessary to rework Plastic plug		4	
44	999 591 384 40	Cap		4	
45	911 565 259 40	Roof frame seal Roof frame	/L	1	
(45)	911 565 260 40	Roof frame seal Roof frame	/R	1	
46	911 565 091 45	Gasket Roll bar		1	
47	911 565 147 41	Rubber stop		2	
48	N 013 953 2	Oval-head sheetmetal screw B 2,9 X 13		2	
49	911 565 187 40	Mounting Locking bolt		1	
50	N 013 957 5	Oval-head sheetmetal screw B 3,5 X 9,5		4	
51	900 025 002 02	Washer 4,3		4	
51	900 025 002 03	Washer 4,3		4	
52	911 565 133 40	Supporting plate		1	
52	911 565 133 40 GRV	Supporting plate Prime coated		1	
53	911 565 135 40	Cover plate		1	
54	911 565 189 41	Cover plate		1	
55	900 145 003 07	Tapping screw B 3,5 X 9,5		1	

Model: 911 78

Model life 1978>>1983

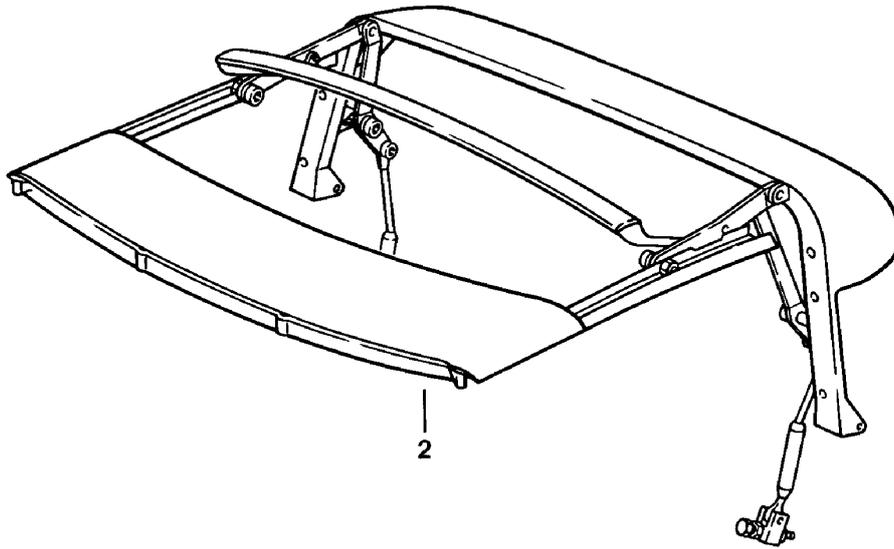
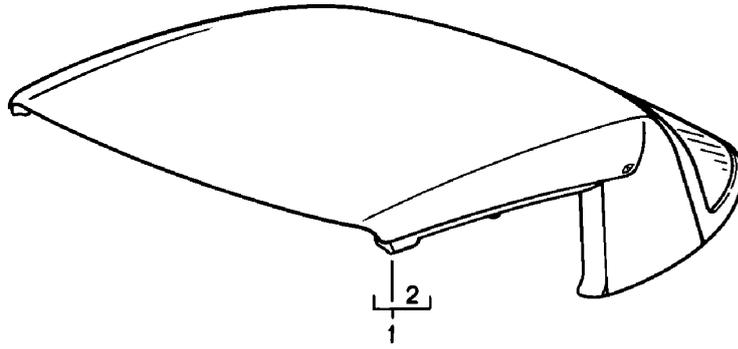

Model: 911 78

Model life 1978>>1983

Pos	Part Number	Description	Remark	Qty	Model
1	911 561 005 00	Convertible top Convertible top frame Manually		1	
	911 561 005 00 3AV	Convertible top Black			
2	911 561 011 00	Convertible top frame		1	

Model: 911 78

Model life 1978>>1983

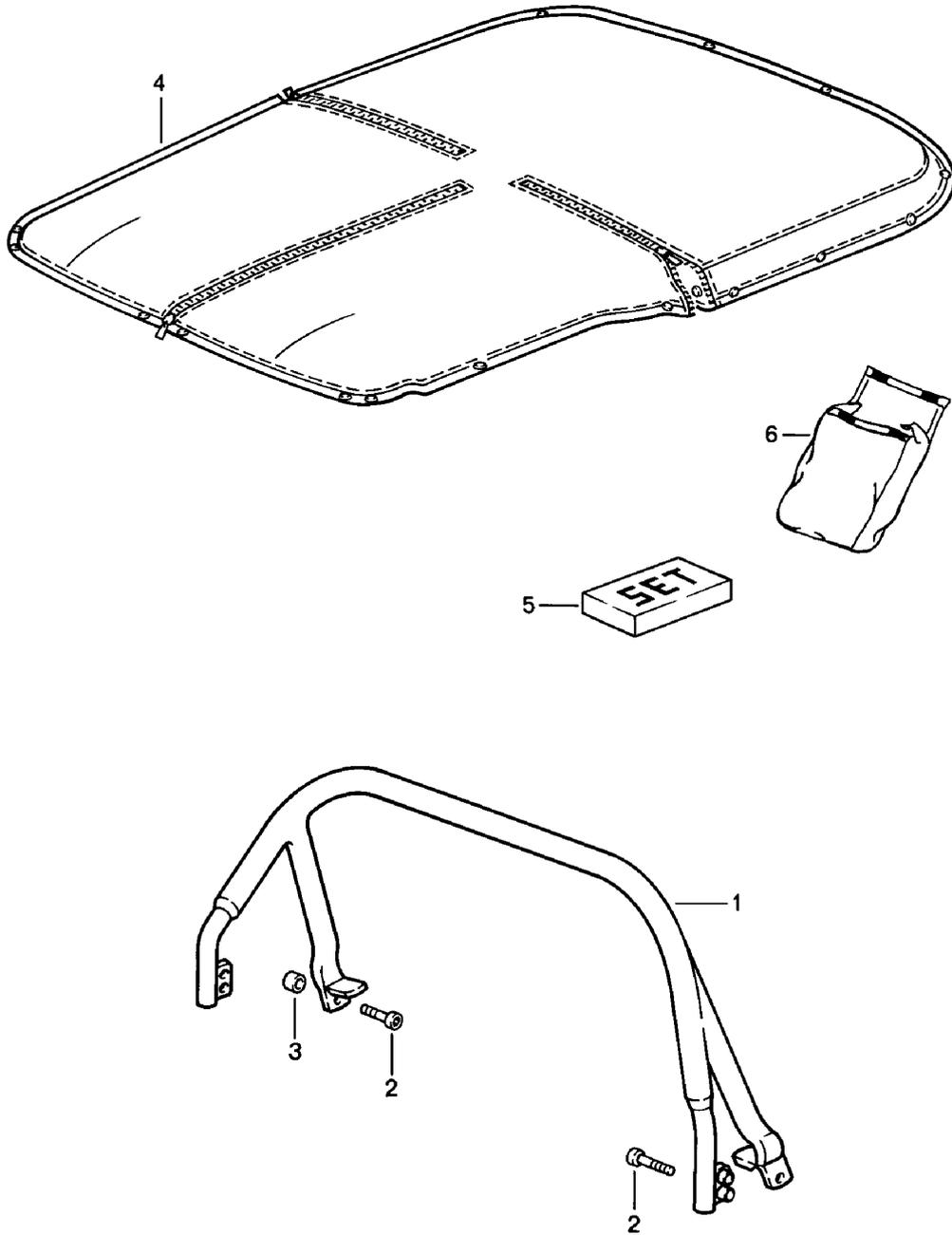

Model: 911 78

Model life 1978>>1983

Pos	Part Number	Description	Remark	Qty	Model
1	911 565 907 61	Protective bracket Tonneau cover Protective bracket Leatherette Black		1	
1	911 565 907 62	Protective bracket Leather Black		1	
2	900 119 090 07	Pan-head screw M 10 X 40		4	
(2)	900 119 006 07	Pan-head screw M 10 X 35		2	
3	911 565 247 60	Bush		2	
4	911 561 923 00	Tonneau cover	/LL	1	
(4)	911 561 924 00	Tonneau cover	/RL	1	
	911 561 924 00 3AV	Black			
5	911 561 921 00	Installation set		1	
6	911 561 087 00	Bag		1	

Model: 911 78

Model life 1978>>1983

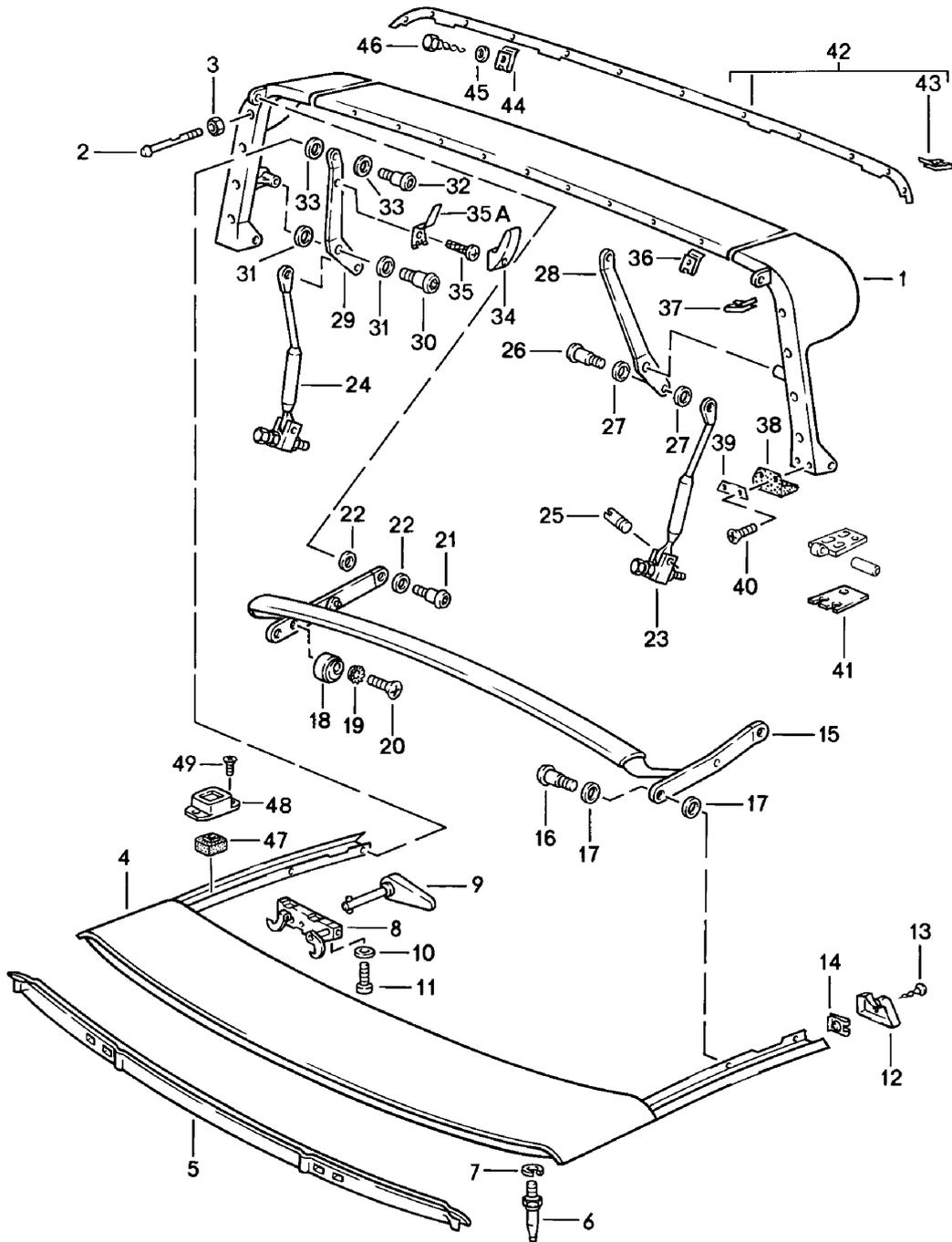

Model: 911 78

Model life 1978>>1983

Pos	Part Number	Description	Remark	Qty	Model
		Main folding top bow			
		Roof frame			
		Single parts			
1	911 561 015 00	Main folding top bow		1	
2	911 561 449 00	Retaining pivot		2	
3	900 076 010 02	Nut		2	
		M 6			
3	900 076 010 0B	Nut		2	
		M 6			
4	911 561 027 00	Roof frame		1	
5	911 565 269 60	Lining		1	
6	911 565 074 40	Locating peg		2	
7	N 012 228 3	Spring washer		2	
		B 8			
8	911 565 031 41	Catch		2	
9	911 565 075 41	Handle		2	
10	N 011 524 7	Washer		4	
		A 6,4			
10	N 011 524 27	Washer		4	
		A 6,4			
11	999 218 015 02	Pan-head screw		4	
		Micro-self-locking			
		M 6 X 12			
11	999 218 015 01	Pan-head screw		4	
		Micro-self-locking			
		M 6 X 12			
12	911 561 139 00	End piece	/L	1	
(12)	911 561 140 00	End piece	/R	1	
13	N 014 086 12	Tapping screw		2	
		3,5 X 13			
13	N 014 086 1C	Tapping screw		2	
		3,5 X 13			
14	999 591 349 02	Speed nut		2	
		B 3,5			
15	911 561 019 00	Intermed. folding top bow		1	
15		Intermed. folding top bow		1	
	911 561 019 00 70B	Black			
16	911 561 461 00	Screw		2	
		M 8 X 20			
17	911 561 428 00	Washer		4	
		10,5			
18	911 561 402 00	Eccentric washer		2	
19	N 012 140 1	Shake-proof washer		2	
20	N 033 185 1	Countersunk-head screw		2	
		M 4 X 16			
21	911 561 421 00	Screw		2	
		M 8 X 24			
21	911 561 426 00	Screw		2	
		M5 x 12			
22	911 561 428 00	Washer		4	
		10,5			
23	911 561 041 00	Steering arm	/L	1	
24	911 561 042 00	Steering arm	/R	1	
25	911 561 425 00	Screw		2	
25	911 561 425 01	Screw		2	
26	911 561 418 00	Screw		2	
		M 8 X 20			
27	911 561 428 00	Washer		4	
		10,5			
28	911 561 171 00	Steering arm	/L	1	
29	911 561 172 00	Steering arm	/R	1	
30	911 561 420 00	Screw		2	
		M 10 X 28			

Model: 911 78 Model life 1978>>1983

Pos	Part Number	Description	Remark	Qty	Model
31	911 561 430 00	Washer 13,5		4	
32	911 561 461 00	Screw M 8 X 20		2	
33	911 561 428 00	Washer 10,5		4	
34	901 552 871 40	Cover		2	
35	900 250 006 02	Tapping screw AM 5 X 10		2	
35A	901 552 872 20	Coat hook		2	
36	999 507 020 02	Speed nut 4,2		7	
36	999 507 020 01	Speed nut 4,2		7	
37	999 507 018 02	Speed nut 4,2		2	
37	999 507 018 01	Speed nut 4,2		2	
38	911 561 471 00	Gasket		2	
39	911 561 475 00	Plate		2	
40	900 269 056 07	Countersunk-head screw M 4 X 10		4	
41	911 561 423 00	Plate 2 MM		X	
41	911 561 423 01	Plate 1 MM		X	
42	911 561 035 00	Rail		1	
43	999 591 582 02	Speed nut 4,2		4	
44	999 507 032 02	Speed nut 3,9		11	
45	900 151 001 02	Washer 4,3		11	
46	900 187 037 07	Hexagon-head tapping screw 4,2 X 16		11	
47	911 561 453 00	Buffer		2	
48	911 561 451 00	Housing		2	
	911 561 451 00 70B	Black			
49	900 269 043 02	Countersunk-head screw M 4 X 12		4	

Model: 911 78

Model life 1978>>1983

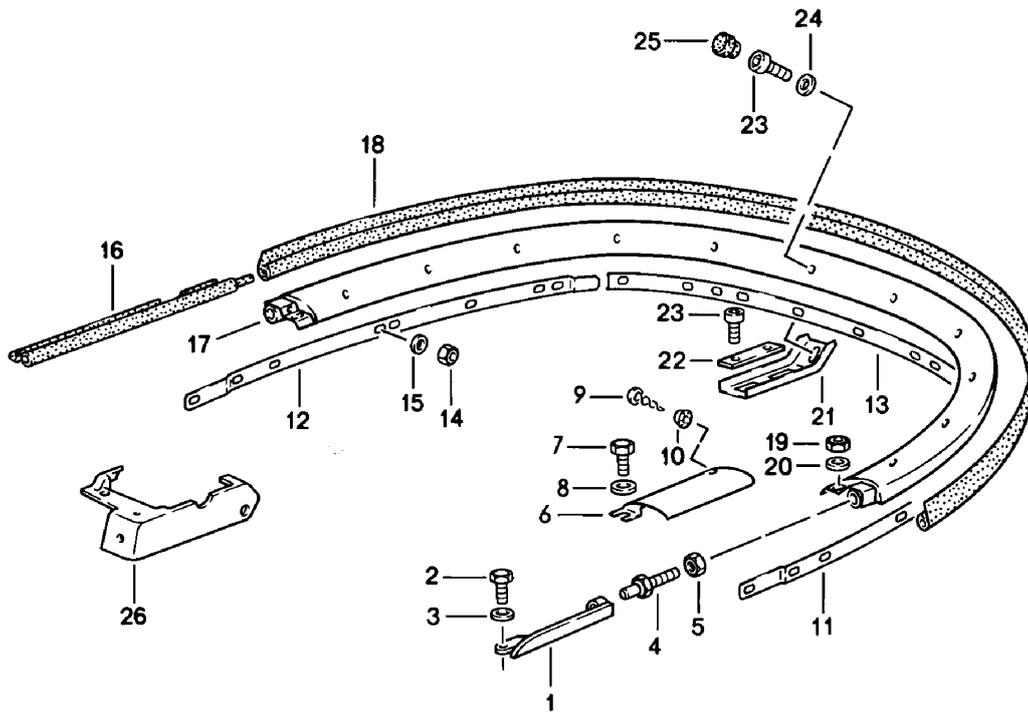

Model: 911 78 Model life 1978>>1983

Pos	Part Number	Description	Remark	Qty	Model
		Convertible top			
		Clamp			
		Single parts			
1	911 561 341 01	Tensioner blade	/L	1	
(1)	911 561 342 01	Tensioner blade	/R	1	
2	N 010 210 7	Hexagon-head bolt M 6 X 10		3	
3	900 025 047 07	Washer A 6,4		2	
4	911 561 331 00	Locating peg		2	
5	900 076 062 07	Hexagon nut M 8		2	
6	911 555 077 60	Rear cover moulding	/L	1	
(6)	911 555 078 60	Rear cover moulding	/R	1	
7	900 075 085 02	Hexagon-head bolt M 8 X 20		6	
8	900 025 007 02	Washer A 8,4 X 16 X 1,6		6	
8	900 025 007 03	Washer A 8,4 X 16 X 1,6		6	
9	N 014 093 3	Oval-head sheetmetal screw 4,2 X 13		2	
10	999 591 116 07	Cone washer		2	
11	911 561 283 00	Rail	/L	1	
12	911 561 284 00	Rail	/R	1	
13	911 561 281 00	Rail Centre		1	
14	N 011 005 14	Hexagon nut M 5		19	
14	900 076 091 01	Hexagon nut M 5		19	
15	900 025 003 02	Washer 5,3		19	
(16)	911 561 463 00	Gasket	/L	1	
(16)	911 561 463 01	Gasket	/L	1	
16	911 561 464 00	Gasket	/R	1	
16	911 561 464 01	Gasket	/R	1	
17	911 561 083 01	Clamp		1	
18	911 561 371 00	Sealing rubber		1	
19	900 076 010 02	Nut M 6		2	
19	900 076 010 0B	Nut M 6		2	
20	N 011 524 7	Washer A 6,4		2	
20	N 011 524 27	Washer A 6,4		2	
21	911 561 379 00	Support		3	
22	911 561 387 00	Desk pad		1	
23	N 014 761 2	Pan-head screw M 6 X 12		9	
23	900 119 129 01	Pan-head screw M 6 X 12		8	
24	N 011 524 7	Washer A 6,4		3	
24	N 011 524 27	Washer A 6,4		3	
25	999 703 169 40	Cap		3	
(26)	911 555 763 63	Cover	/L	1	
26	911 555 764 63	Cover	/R	1	
-	999 591 835 17	Snap fastener lower part		2	
-		Snap fastener lower part		2	
-	999 190 162 37	Blind rivet		2	

Model: 911 78

Model life 1978>>1983

Pos	Part Number	Description	Remark	Qty	Model
-	PCG 190 162 37	Blind rivet		2	

Model: 911 78

Model life 1978>>1983

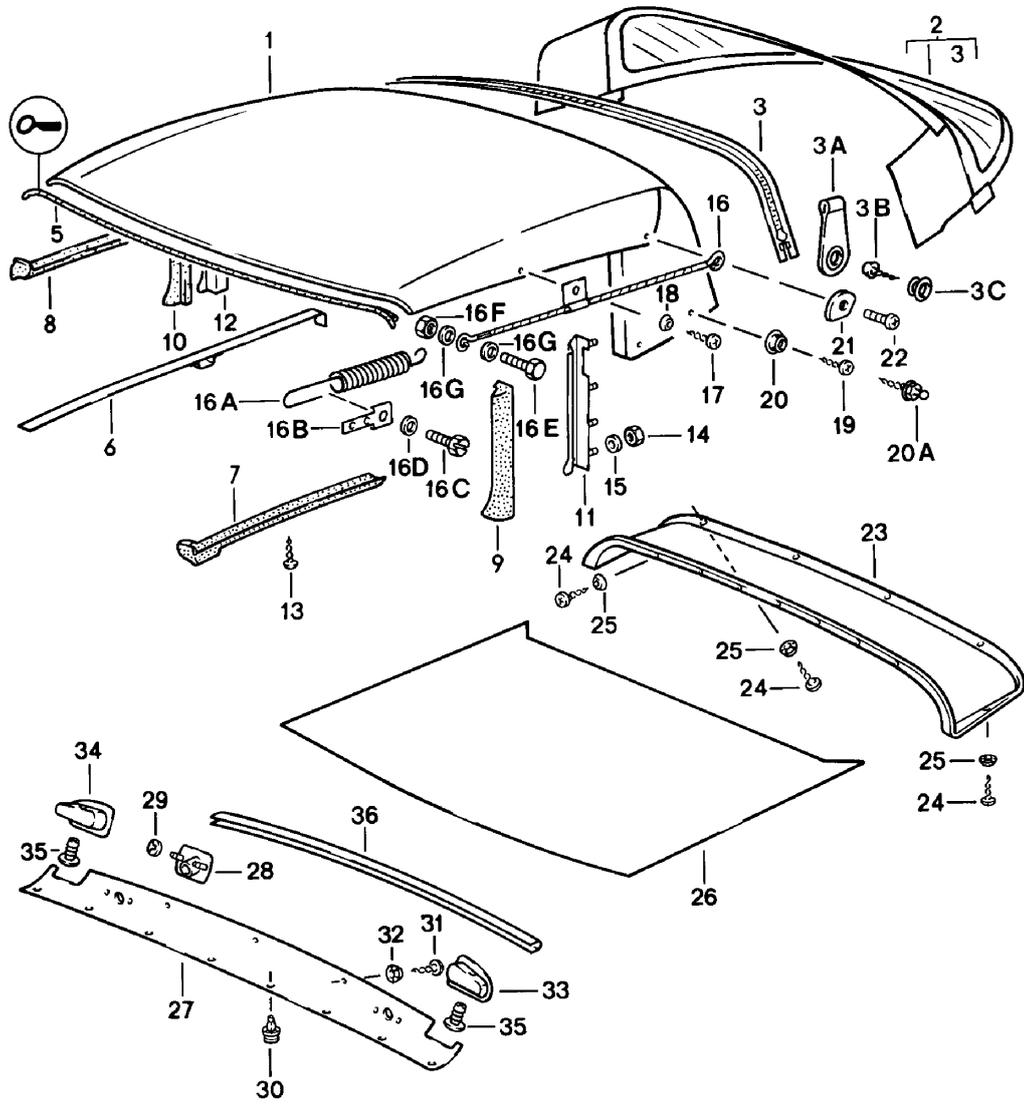

Model: 911 78

Model life 1978>>1983

Pos	Part Number	Description	Remark	Qty	Model
1	911 561 051 00	Convertible top Seal Single parts Convertible top covering Roof	/V	1	
2	911 561 051 00 3AV 911 561 053 00	Black Rear window with Cover	/H	1	
-	911 561 053 00 3AV	Black			
3	911 561 359 00	Rear window		1	
-	911 561 405 01 911 561 405 01 3AV	Zip Black		1	
-	000 043 022 00 000 043 022 00 3AV	Zip Black		X	
3A	911 561 523 01	Traction noose		1	
	911 561 523 01 1AJ	Black			
3B	900 144 028 07	Tapping screw		1	
3C	911 561 485 00	Snap fastener lower part		1	
3C	999 591 835 17	Snap fastener lower part		1	
5	911 561 244 01	Roof frame seal		1	
6	911 561 153 65	Restraining strap		2	
7	911 561 205 00	Seal	/L	1	
8	911 561 206 00	Seal	/R	1	
9	911 561 221 01	Gasket	/L	1	
10	911 561 222 01	Gasket	/R	1	
11	911 561 025 00	Rail	/L	1	
12	911 561 026 00	Rail	/R	1	
13	N 013 958 7	Oval-head sheetmetal screw B 3,5 X 13		8	
14	900 076 010 07	Hexagon nut M 6		8	
15	900 025 047 07	Washer 6,4		8	
16	911 561 239 00	Tension rope	/L	1	
(16)	911 561 240 00	Tension rope	/R	1	
16A	911 561 403 01	Tension spring		2	
16B	911 561 407 00	Support		2	
16C	N 010 211 4	Hexagon-head bolt M 6 X 12		2	
16D	N 011 524 7	Washer 6,4		4	
16D	N 011 524 27	Washer 6,4		4	
16E	900 075 100 02	Hexagon-head bolt M 4 X 12		2	
16E	900 075 100 03	Hexagon-head bolt M 4 X 12		2	
16F	900 910 006 02	Lock nut M 4		4	
16F	900 084 020 01	Lock nut M 4		4	
16G	N 011 522 14	Washer 4,3		4	
17	900 144 028 07	Tapping screw B 3,5 X 13		2	
18	999 591 102 17	Washer D 3,5 X 11		2	
18	999 591 102 1H	Washer D 3,5 X 11		2	
19	900 144 028 07	Tapping screw B 3,5 X 13		2	
20	999 591 835 17	Snap fastener lower part		14	

Model: 911 78

Model life 1978>>1983

Pos	Part Number	Description	Remark	Qty	Model
20A	999 591 598 02	Tenax lower part B 4,2 X 16		2	
(20A)	999 591 597 02	Tenax lower part B 4,2 X 10		6	
21	911 561 455 00	Corner piece		2	
22	N 033 203 2	Countersunk-head screw M 4 X 18		2	
23	911 561 059 00	Lining		1	
24	900 145 096 07	Oval-head sheetmetal screw 4,2 X 16		13	
24	900 145 096 0G	Oval-head sheetmetal screw 4,2 X 16		13	
25	999 591 116 07	Cone washer		13	
26	911 561 050 00	Roofliner		1	
27	911 565 093 60	Padded cover		1	
28	911 565 279 60	Rosette		2	
29	999 591 676 02	Clamping washer \$=7		4	
29	999 591 676 01	Clamping washer \$=7		4	
30	823 867 299	Clip		8	
31	N 014 093 3	Oval-head sheetmetal screw 4,2 X 13		3	
32	999 591 116 07	Cone washer 4,5 90 DEG		3	
33	911 565 271 60	Handle	/L	1	
34	911 565 272 60	Handle	/R	1	
35	999 591 587 40	Expansion rivet		2	
36	911 555 593 61	Edge protection		1	
-	911 565 299 60	Moltoprene shim		2	
-	911 565 297 60	Edge protection Cover Edge protection		1	

Model: 911 78

Model life 1978>>1983

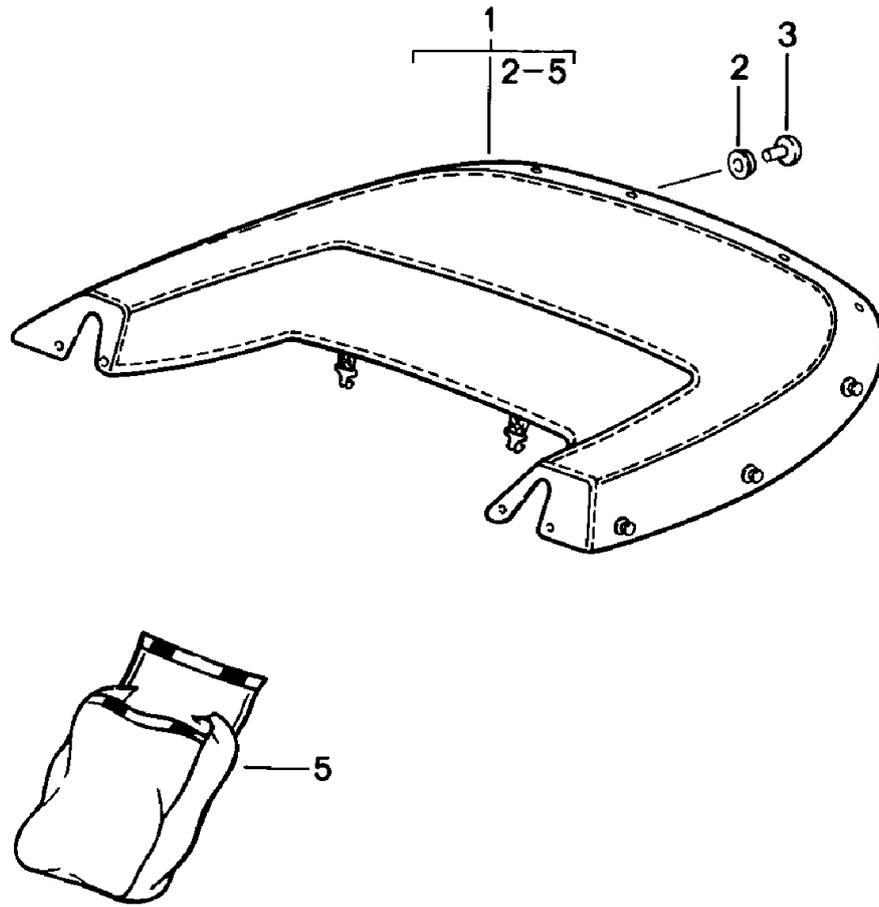

Model: 911 78

Model life 1978>>1983

Pos	Part Number	Description	Remark	Qty	Model
1	911 561 023 00	Convertible top cover		1	
	911 561 023 00 3AV	Convertible top cover Black			
-	999 591 598 02	Tenax lower part B 4,2 X 16		X	
-	999 591 983 12	Tenax upper part		X	
(2)	999 591 836 17	Push button		14	
2		Push button \$=9,5		X	
(3)	999 591 838 17	Push button		14	
3		Push button \$=4/15		X	
5	911 561 087 00	Bag		1	

Model: 911 78

Model life 1978>>1983

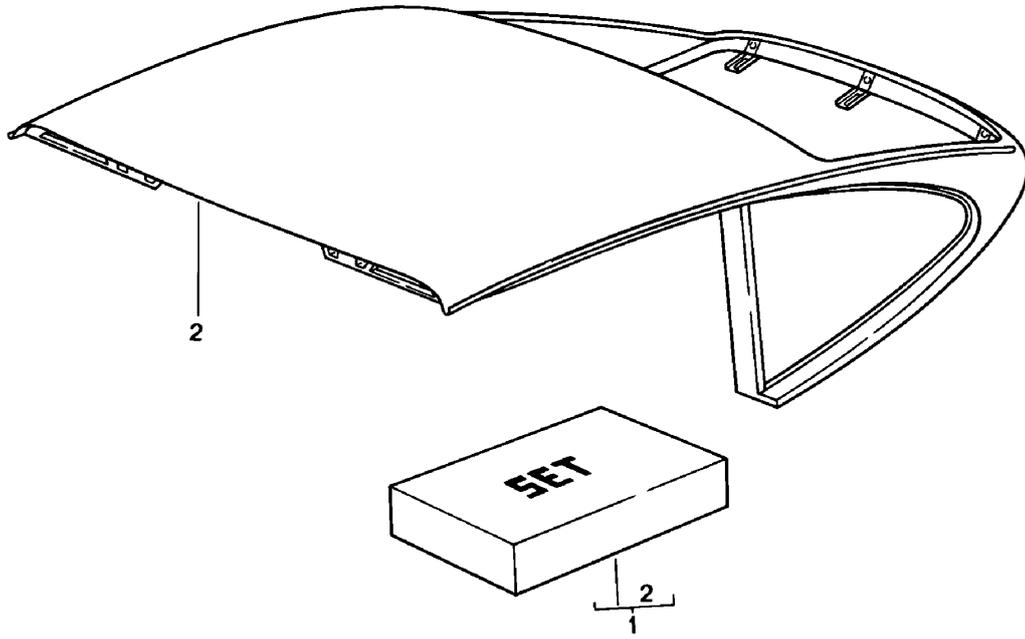

Model: 911 78

Model life 1978>>1983

Pos	Part Number	Description	Remark	Qty	Model
1	911 561 901 00	Hardtop Installation set Leatherette Black		1	
2	911 503 969 00	Roof		1	

Model: 911 78

Model life 1978>>1983

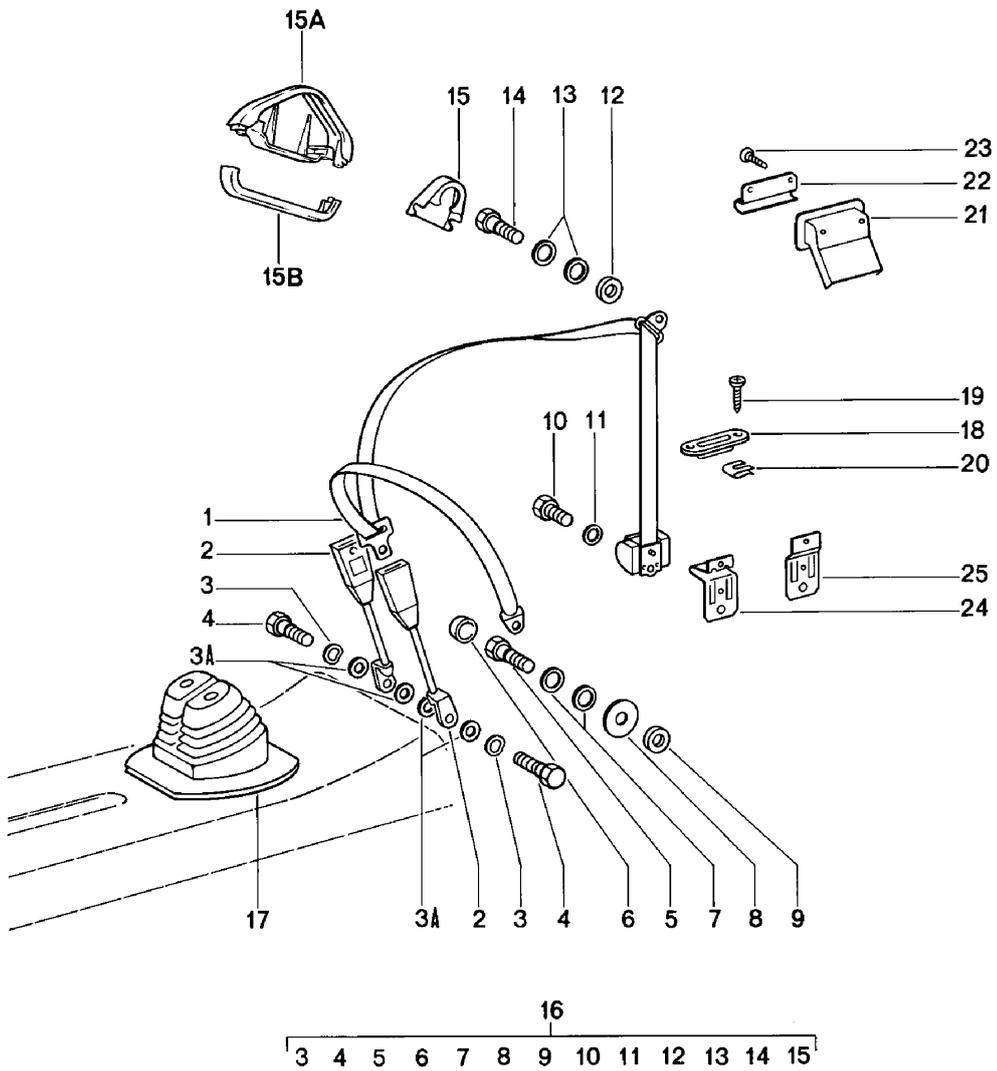

Model: 911 78 Model life 1978>>1983

Pos	Part Number	Description	Remark	Qty	Model
1	928 803 126 09	Seat belt Front	-79	2	
(1)		Seat belt Automatic	(AUS)		
(1)		Not for Seat belt Automatic	(AUS) -79	2	
2	911 803 183 00	Seat-belt buckle Not for	-79 (GB)	2	
(2)	928 803 183 05	Seat-belt buckle	-79	2	
(2)		Seat-belt buckle	80-	2	
3	999 025 113 02	Washer 11,5 X 21 X 2		X	
3A	211 857 771	Washer	80-	4	
4	111 857 793 E	Hexagon-head bolt		2	
5		Hexagon-head bolt		2	
6	811 857 845	Cap		2	
7	211 857 771	Washer		4	
8	901 803 144 00	Washer		2	
9	999 025 113 02	Washer 11,5 X 21 X 2		2	
10	911 803 150 00	Screw		2	
12	999 025 113 02	Washer		2	
13	211 857 771	Washer		4	
(13)	928 803 157 02	Washer		4	
14	111 857 793 E	Hexagon-head bolt		2	SC
(14)		Hexagon-head bolt		2	TARGA/CABRIO
15	911 803 233 01	Cap	-80	2	
15A	928 803 141 00	Cover Upper part		2	
15B	928 803 143 00	Cover Lower part		2	
16	911 803 907 00	Set of fastening parts	-79	1	COUPE
(16)	911 803 907 40	Set of fastening parts	-79	1	TARGA
(17)	911 555 102 01	Bellows		1	
(18)	911 555 615 01	Rosette		2	COUPE
19	N 014 093 3	Oval-head sheetmetal screw BZ 4,2 X 13		4	COUPE
20	999 507 020 02	Speed nut 4,2		4	COUPE
20	999 507 020 01	Speed nut 4,2		4	
21	901 803 139 00	Rosette		2	TARGA
22	911 555 619 40	Relay lever		2	TARGA
(22)	911 555 619 60	Relay lever	/L	1	CABRIO
(22)	911 555 620 60	Relay lever	/R	1	CABRIO
23	900 145 071 07	Tapping screw B 3,5 X 13		4	TARGA/CABRIO
(24)	911 555 625 00	Support for seatbelt		2	COUPE
(24)	911 501 461 61	Support for seatbelt		2	CABRIO
25	911 555 613 41	Support for seatbelt		2	TARGA

Model: 911 78

Model life 1978>>1983

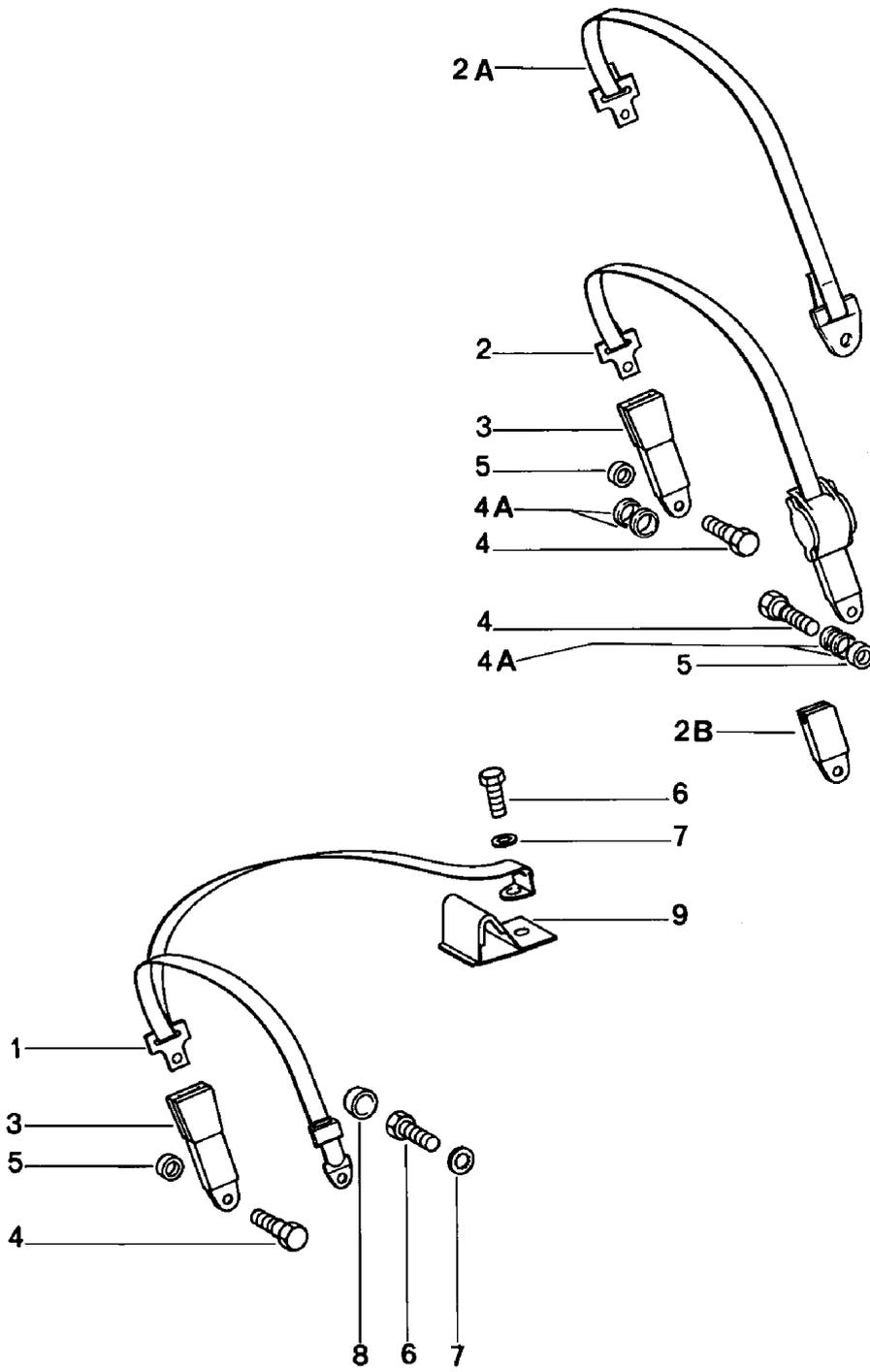

Model: 911 78 Model life 1978>>1983

Pos	Part Number	Description	Remark	Qty	Model
		Seat belt Rear			
1	911 803 049 04	Seat belt Automatic	(AUS) -79	2	
(1)	911 803 049 05	Seat belt Automatic	(AUS) 80-	2	
(2)	477 857 787 B	Belt Automatic	-82	2	
2A	477 857 795	Seat belt Manually		2	
(2B)	477 857 750 B	Cap		2	
3	478 857 739 A	Seat-belt buckle	(AUS) -79	2	
(3)	477 857 739 A	Seat-belt buckle	(F) (J) -79	2	
(3)	477 857 739	Seat-belt buckle	(F) (J)	2	
	477 857 739 70B	Black			
(3)	477 857 739 A	Seat-belt buckle	80-	2	
(3)	477 857 739 B	Seat-belt buckle	80-	2	
	477 857 739 B 70B	Black			
4	911 803 451 00	Fastening screw		2	
4A	211 857 771	Washer		4	
5	901 803 116 40	Spacer sleeve		2	
6	111 857 799	Hexagon-head bolt	(AUS)	4	
7	N 012 112 2	Serrated lock washer	(AUS) -81	4	
8	811 857 845	Cap	(AUS)	2	
9	911 803 059 04	Relay lever	(AUS)	2	

Model: 911 78

Model life 1978>>1983

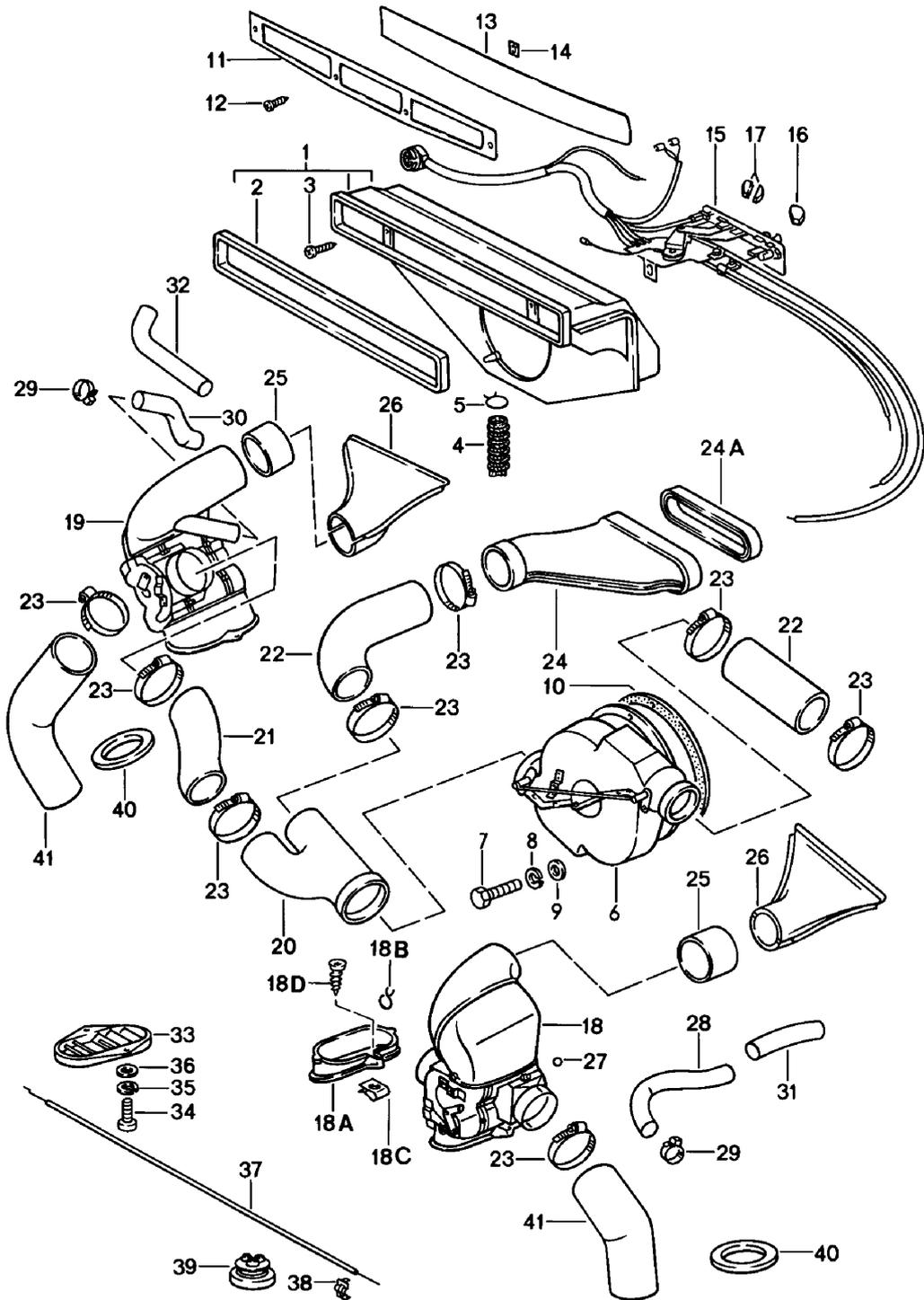

Model: 911 78 Model life 1978>>1983

Pos	Part Number	Description	Remark	Qty	Model
		Ventilation			
		Heating system 1			
1	911 571 031 00	Fresh air inlet box	/LL	1	
(1)	911 571 041 01	Fresh air inlet box	/LL	1	
		Order also:			
		POS. 2, 6-10			
(1)	911 571 032 00	Fresh air inlet box	/RL	1	
(1)	911 571 042 01	Fresh air inlet box	/RL	1	
		Order also:			
		POS. 2, 6-10			
2	901 571 325 32	Sealing frame		1	
3	N 014 153 1	Oval-head screw		2	
		M 5 X 40			
4	911 571 224 00	Water drain hose	/LL/RL	1	
		600 MM			
5	999 512 145 02	Hose clamp	/RL	1	
6	911 571 017 00	Blower		1	
6	911 571 018 00	Blower		1	M559/573
-	911 571 905 00	Housing		1	
		Front			
-	911 571 907 00	Housing		1	
		Rear			
-	911 571 320 32	Blower motor		1	
7	N 010 205 6	Hexagon-head bolt		2	
		M 5 X 10			
7	900 075 105 02	Screw		2	
		M 5 X 10			
8	900 027 011 01	Lock ring		2	
		B 5			
9	900 025 003 02	Washer		2	
		5,3			
10	901 571 922 00	Sealing ring		1	
10	901 571 922 01	Sealing ring		1	
11	911 559 401 00	Grille frame		1	
12	N 014 086 12	Tapping screw		4	
		B 3,5 X 13			
12	N 014 086 1C	Tapping screw		4	
		B 3,5 X 13			
13	911 559 410 00	Grille		1	
13		Grille		1	
13	911 559 410 00 70K				
13	993 559 411 00	Grille		1	
14	901 559 491 20	Spacer		2	
15	911 613 111 10	Control switch	/LL	1	
(15)	911 613 112 07	Control switch	/RL	1	
-	911 612 172 01	Wiring harness		1	
		for			
		Control switch			
-	900 631 132 90	Bulb		1	
		12V, 2W			
-	999 632 006 00	Bulb socket		1	
-	914 571 903 10	Sealing ring		1	
-	N 010 217 9	Hexagon-head bolt		1	
		M 6 X 20			
-	N 011 524 7	Washer		1	
		6,4			
-	N 011 524 27	Washer		1	
		6,4			
-	914 571 151 10	Rubber sleeve		1	
		Bowden control			
-	911 613 153 00	Grommet	/RL 83-	1	
		Bowden control			
16	901 571 917 00	Knob		1	

Model: 911 78 Model life 1978>>1983

Pos	Part Number	Description	Remark	Qty	Model
16	901 571 918 00	Black Knob		1	
17	911 613 995 00	Red Knob		2	
18	911 571 049 07	Black Control box		1	
18A	911 571 051 00	Connecting flange		2	
18B	999 512 162 02	Clamping spring		4	
18C	999 591 574 02	Speed nut B 4,8	82-	4	
18D	900 143 039 02	Tapping screw BZ 4,8 X 19	82-	4	
19	911 571 050 07	Control box		1	
20	911 571 039 00	Distributing piece	/LL	1	
(20)	911 571 040 00	Distributing piece	/RL	1	
21	911 571 239 00	Air hose		1	
22	473 261 233 A	Air hose		2	
23	999 512 349 02	Hose clamp		8	
23	999 512 349 01	Hose clamp		8	
23	999 512 349 0B	Hose clamp		8	
24	911 571 085 00	Air duct	/LL	1	
(24)	911 571 086 01	Air duct	/RL	1	
24A	911 571 189 00	Sealing ring		1	
25	901 571 345 32	Hose piece		2	
26	901 572 045 31	Heating nozzle		2	
27	901 571 921 00	Retainer		24	
28	911 571 228 00	Air hose		1	
29	999 512 551 00	Hose clamp		1	
30	911 571 228 00	Air hose		1	
(31)	911 572 223 00	Air hose		1	
32	911 571 228 00	Air hose		1	
33	911 571 347 01	Air distributor	/L	1	
(33)	911 571 348 01	Air distributor	/R	1	
(33)		Air distributor	/LL	2	M559
34	N 044 734 1	Pan-head screw M 5 X 15		4	
34	900 067 137 01	Pan-head screw M 5 X 15		4	
35	N 012 005 3	Lock ring B 5		4	
36	900 025 003 02	Washer 5,3		4	
37	911 572 114 00	Bowden control		2	
38	901 571 919 00	Terminal		7	
(38)	477 819 343	Control box 911.571.050.03 Spring clamp		4	
		Control box 911.571.050.05			
39	911 612 863 00	Grommet		1	
39	914 571 151 10	Rubber sleeve		1	
40	901 572 913 01	Sealing ring		2	
41	914 572 123 10	Air hose		2	
41		Air hose	83-	1	TURBO

Model: 911 78

Model life 1978>>1983

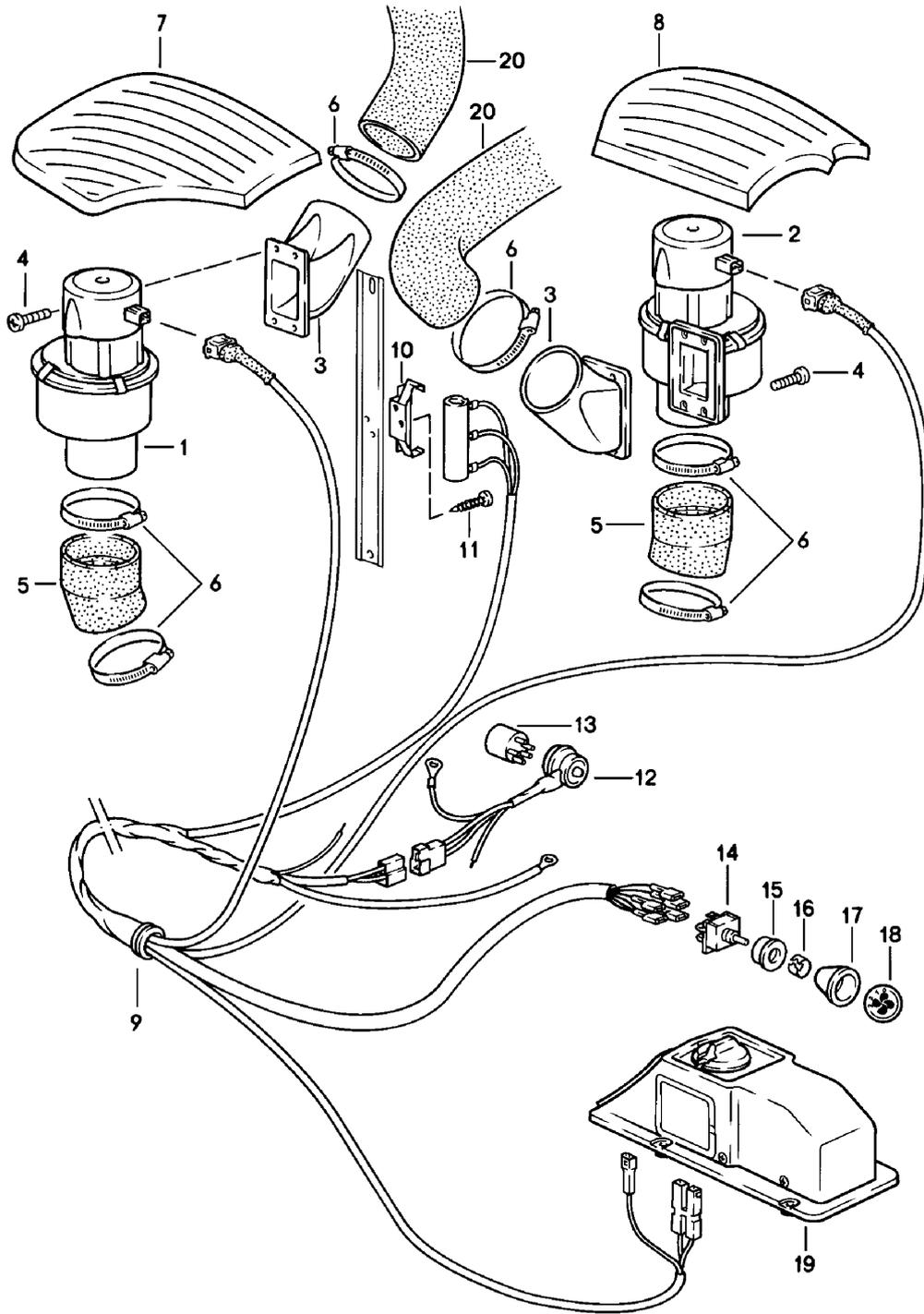

Model: 911 78

Model life 1978>>1983

Pos	Part Number	Description	Remark	Qty	Model
		Additional blower	83-		TURBO
1	911 624 043 02	Radial blower	/L	1	
2	911 624 044 02	Radial blower	/R	1	
3	930 571 102 00	Connection piece		2	
4	900 146 009 02	Oval-head screw M 4 X 12		8	
5	930 571 101 01	Hot air socket		2	
6	999 512 349 02	Hose clamp		6	
6	999 512 349 01	Hose clamp		6	
6	999 512 349 0B	Hose clamp		6	
7	930 571 107 00	Damping mat	/L	1	
8	930 571 108 00	Damping mat	/R	1	
9	930 612 113 01	Wiring harness	/LL	1	
(9)	930 612 113 02	Wiring harness	/RL	1	
10	930 616 113 00	Support		1	
11	900 143 058 02	Tapping screw BZ 4,8 X 9,5		2	
12	930 612 115 00	Wiring harness		1	
13	911 615 109 01	Standard type relay		1	
14	911 613 116 00	Blower switch		1	
15	911 613 213 05	Rosette		1	
16	999 591 557 01	Knob holder		1	
17	911 613 141 01	Knob		1	
18	911 613 238 02	Cap with symbol		1	
19	930 659 049 00	Control mechanism		1	
20	914 572 123 10	Air hose		2	

Model: 911 78

Model life 1978>>1983

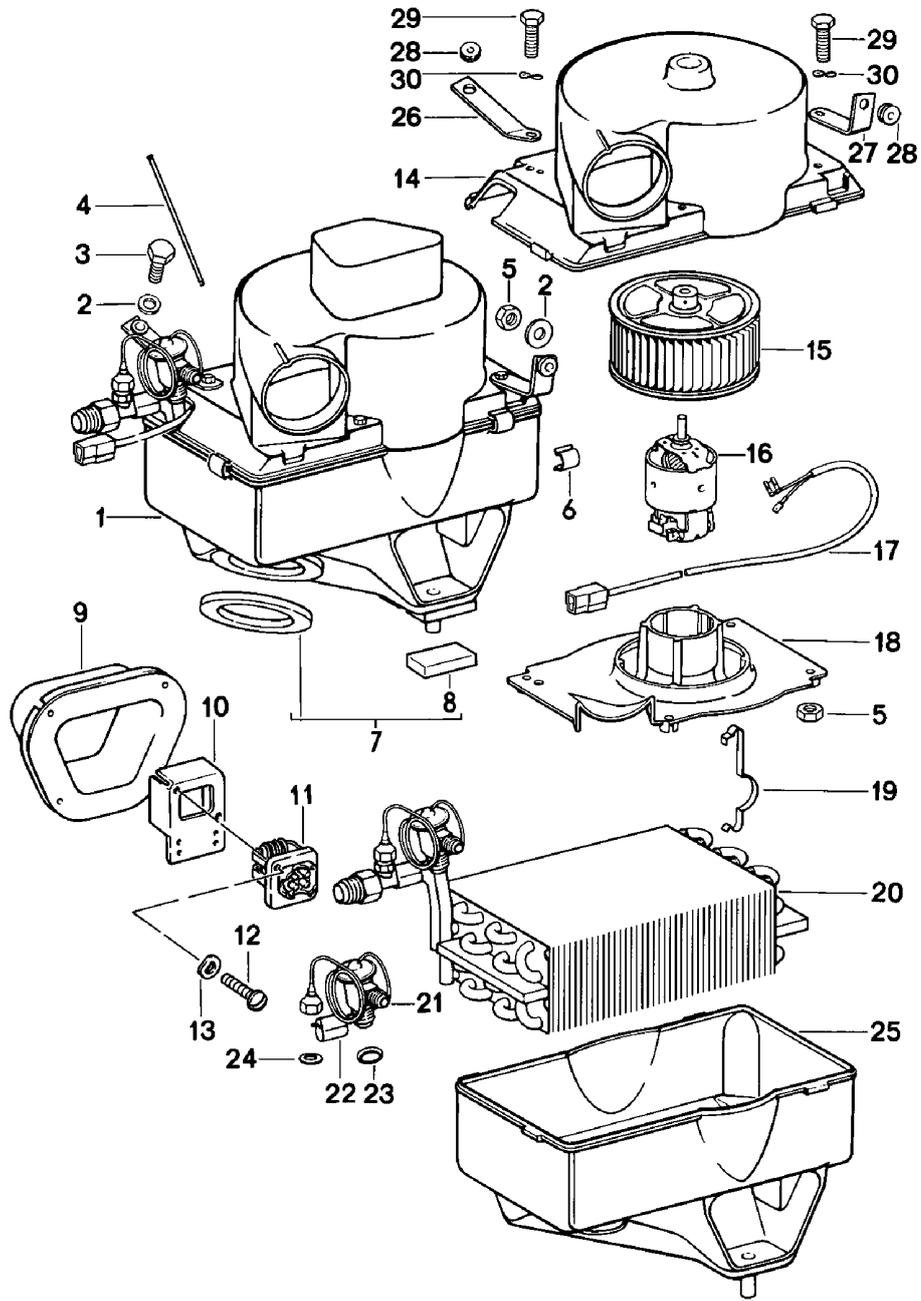

Model: 911 78

Model life 1978>>1983

Pos	Part Number	Description	Remark	Qty	Model
-	911 573 001 10	Air conditioner Evaporator housing Single parts Air conditioner	/LL	1	SC M559
-	911 573 001 11	Air conditioner	/RL	1	SC M559
-	911 573 001 12	Air conditioner	/RL -79	1	SC M399
-	930 573 001 03	Air conditioner	/LL	1	TURBO M559
-	930 573 001 13	Air conditioner	/RL	1	TURBO M559
		for subsequent installation			
1	901 573 021 00	Evaporator	/LL	1	
(1)	911 573 022 00	Evaporator	/RL	1	
2	900 151 003 02	Washer 6,4		2	
2	900 151 006 03	Washer 6,4		2	
3	900 075 057 02	Hexagon-head bolt M 6 X 16		1	
3	900 075 057 03	Hexagon-head bolt M 6 X 16		1	
4	901 573 903 00	Guide tube		1	
		Temperature switch			
5	900 076 010 02	Nut M 6		5	
5	900 076 010 0B	Nut M 6		5	
6	901 573 904 00	Tensioning spring		4	
-	911 573 135 37	Protection cap	/RL	1	
-	911 573 131 37	Water drain sleeve	/RL	1	
-	911 573 143 00	Rubber sleeve	/RL	1	
7	901 573 901 00	Parts kit	/LL	1	
		Comprising:			
-		Sealing ring		1	
8		Shim		2	
(9)	911 573 073 01	Connection piece	/LL	1	
10	478 820 209	Bracket	/LL	1	
11	911 618 151 00	Thermo bi-metal switch	/LL	1	
12	900 146 011 02	Oval-head screw AM 4 X 10	/LL	2	
13	N 012 224 3	Spring washer B 4	/LL	2	
14	911 573 023 00	Housing cover		1	
15	901 573 906 00	Fan		1	
15	901 573 906 01	Fan		1	
16	901 624 901 00	Electric motor		1	
17		See group 8/13/40		1	
18	911 573 323 00	Engine support		1	
19	901 624 903 00	Clamp		4	
20	901 573 907 00	Evaporator without Expansion valve		1	
21	901 573 915 00	Expansion valve		1	
22	901 573 914 00	Clip		1	
23	901 573 147 00	Gasket 3/4"		1	
24	901 573 916 00	Gasket 7/16"		1	
25	901 573 908 00	Housing	/LL	1	

Model: 911 78

Model life 1978>>1983

Pos	Part Number	Description	Remark	Qty	Model
(25)	911 573 122 00	Lower part Housing	/RL	1	
26	911 572 473 00	Lower part Fastening angle	/LL	1	
27	911 572 471 00	Fastening angle	/LL	1	
28	901 573 133 00	Rubber sleeve		2	
29	N 010 217 9	Hexagon-head bolt M 6 X 20		4	
30	N 012 226 5	Spring washer B 6		4	

Model: 911 78

Model life 1978>>1983

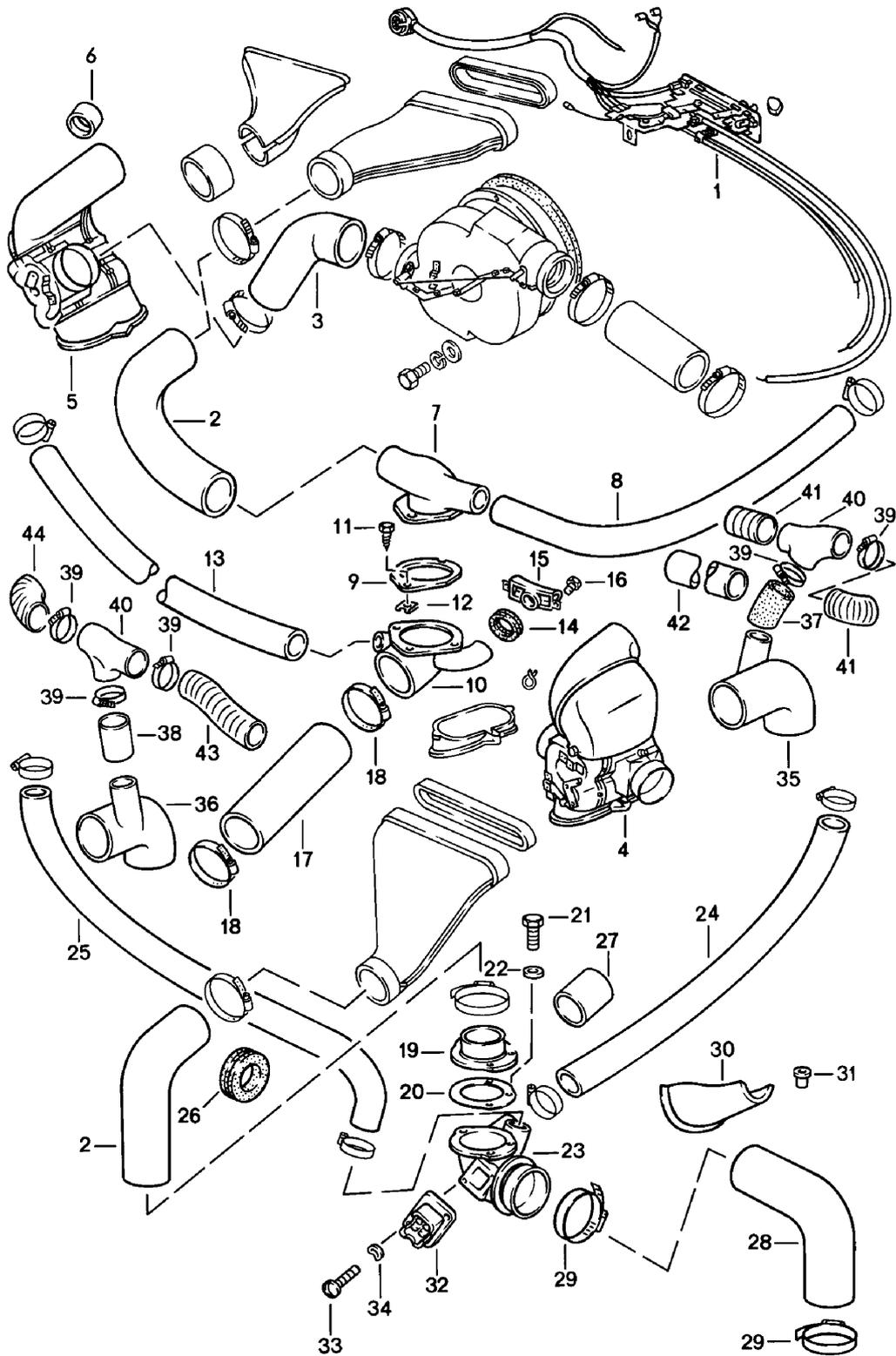

Model: 911 78 Model life 1978>>1983

Pos	Part Number	Description	Remark	Qty	Model
		Cooling air duct			
		Control switch			
1	911 613 111 07	Control switch	/LL	1	
(1)	911 613 112 07	Control switch	/RL	1	
2	911 571 243 00	Air hose		1	
3	473 261 233 A	Air hose		1	
4	911 571 049 07	Control box		1	
5	911 571 050 07	Control box		1	
6	911 573 207 00	Closure for pipe adapter	/LL	1	
7	911 573 179 00	Air distributor	/LL	1	
8	911 573 204 00	Air hose	/LL	1	
9	911 573 173 00	Gasket	/LL	1	
10	911 573 181 00	Connecting piece	/LL	1	
11	900 187 014 02	Hexagon-head tapping screw	/LL	3	
		B 4,2 X 16			
12	999 591 457 02	Speed nut	/LL	3	
		B 4,2			
13	911 571 228 00	Air hose	/LL	1	
14	911 573 185 00	Rubber sleeve	/LL	2	
15	911 573 183 00	Footwell outlet vent	/LL	1	
16	N 010 207 6	Hexagon-head bolt	/LL	2	
		M 5 X 12			
16	N 010 207 17	Hexagon-head bolt	/LL	2	
		M 5 X 12			
17	911 571 240 01	Air hose	/LL	1	
17	911 571 240 02	Air hose	/LL	1	
18	999 512 351 02	Hose clamp	/LL	2	
19	911 573 191 00	Flange socket	/RL	1	
20	901 572 527 00	Sealing washer	/RL	1	
21	N 010 207 6	Hexagon-head bolt	/RL	3	
		M 5 X 12			
21	N 010 207 17	Hexagon-head bolt	/RL	3	
		M 5 X 12			
22	900 025 003 02	Washer	/RL	3	
		5,3			
23	911 573 088 00	Connecting piece	/RL	1	
24	911 573 203 00	Air hose	/RL	1	
25	911 573 204 00	Air hose	/RL	1	
26	901 573 143 00	Rubber sleeve	/RL	3	
27	999 702 062 50	Grommet	/RL	1	
28	911 573 523 02	Air hose	/RL	1	
29	999 512 351 02	Hose clamp	/RL	2	
30	911 551 607 00	Covering	/RL	1	
31	900 121 015 02	Tubular rivet	/RL	4	
		A 6 X 0,5 X 15			
32	911 618 151 00	Thermo bi-metal switch	/RL	1	
33	900 146 011 02	Oval-head screw	/RL	2	
		AM 4 X 10			
34	N 012 224 3	Spring washer	/RL	2	
		A 4			
35	911 573 231 00	Air distributor	/L 82-	1	
		Lower			
36	911 573 232 00	Air distributor	/R 82-	1	
		Lower			
37	911 573 210 00	Air hose	82-	1	
38	911 573 213 00	Air hose	82-	1	
39	999 512 551 00	Hose clamp	82-	5	
40	911 573 235 00	Air distributor	82-	2	COUPE
		Upper			
40		Air distributor	/R 82-	1	TARGA
		Upper			CABRIO
(40)	911 573 233 00	Distributing piece	/L 82-	1	TARGA
		Upper			CABRIO

Model: 911 78

Model life 1978>>1983

Pos	Part Number	Description	Remark	Qty	Model
41	911 573 212 00	Air hose	82-	2	
42	911 573 209 00	Air hose	/RL 82-	1	
43	911 573 203 00	Air hose	/LL 82-	1	
(43)	911 573 204 00	Air hose	/RL 82-	1	
44	911 573 211 00	Air hose	82-	1	

Model: 911 78

Model life 1978>>1983

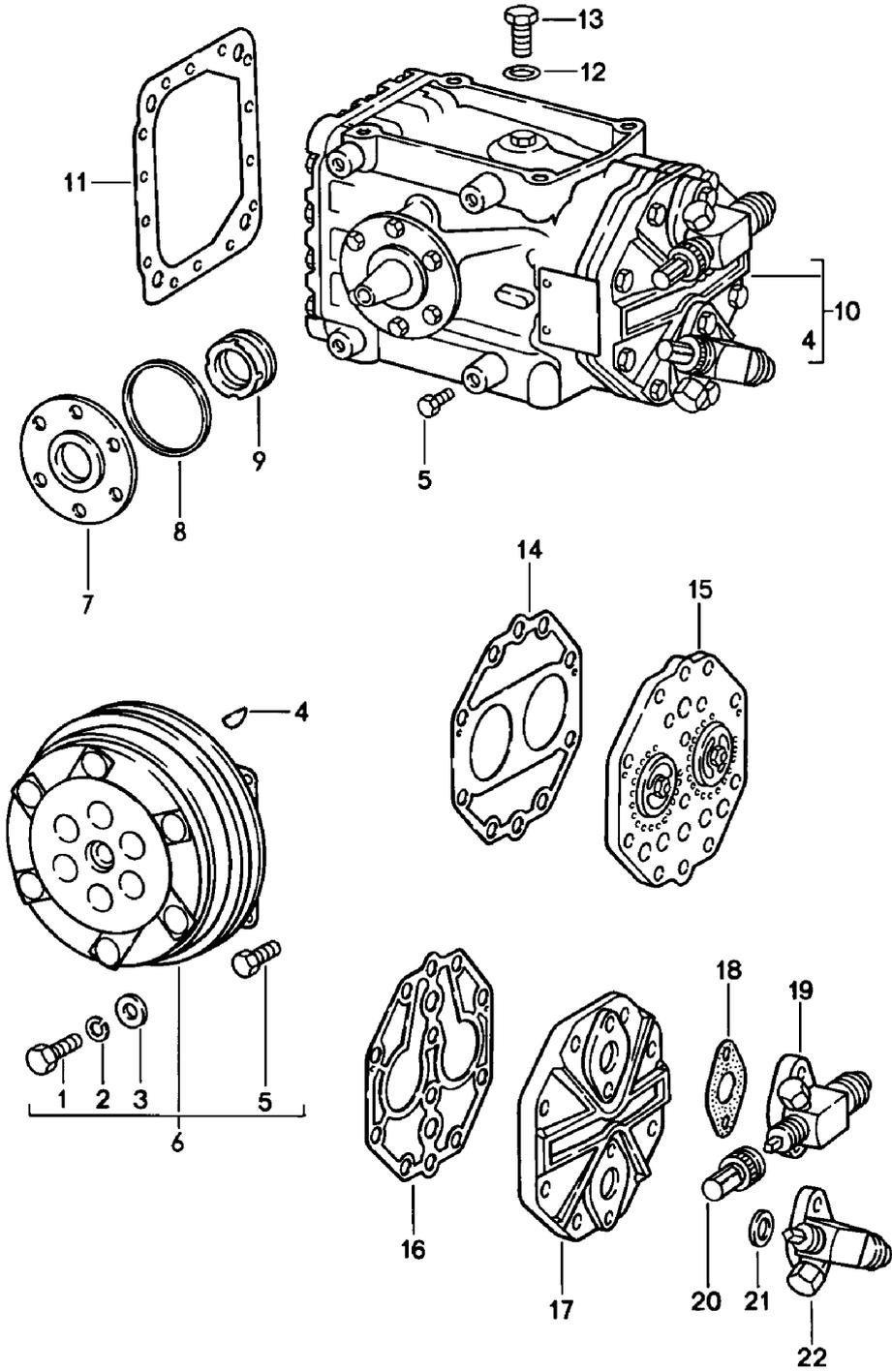

Model: 911 78

Model life 1978>>1983

Pos	Part Number	Description	Remark	Qty	Model
1-5	911 126 924 00	Compressor Compressor Comprising: Hexagon-head bolt 5/16" -24 UNF-1 1/2"		1	911 SC
2		Lock ring B 8		1	
3		Washer 8 X 22 X 4		1	
4		Woodruff key 4 X 6,5		1	
5		Hexagon-head bolt 1/4" -20 UNC-2 AX 1/2"		4	
6	911 126 933 01	Clutch		1	
7-9	911 126 931 00	Parts kit Comprising:		1	
7		Flange		1	
8		Gasket		1	
9		Gasket		1	
10	911 126 901 00	Compressor		1	
11	911 126 911 00	Gasket		1	
12	911 126 913 00	O-ring		2	
13	911 126 912 00	Hexagon-head bolt 3/8" X 15		1	
14-16	911 126 917 00	Parts kit Comprising:		1	
14		Gasket		1	
15		Valve plate		1	
16		Gasket		1	
-	911 126 918 00	Parts kit Comprising:		1	
16		Gasket		1	
17		Lid		1	
-	911 126 916 00	Parts kit Comprising:		1	
14		Gasket		1	
16		Gasket		1	
18	911 126 919 00	Sealing ring		1	
19	911 126 921 00	Flange valve		1	
20	911 126 923 00	Cap		1	
21	911 126 919 00	Sealing ring		1	
22	911 126 922 00	Flange valve		1	

Model: 911 78

Model life 1978>>1983

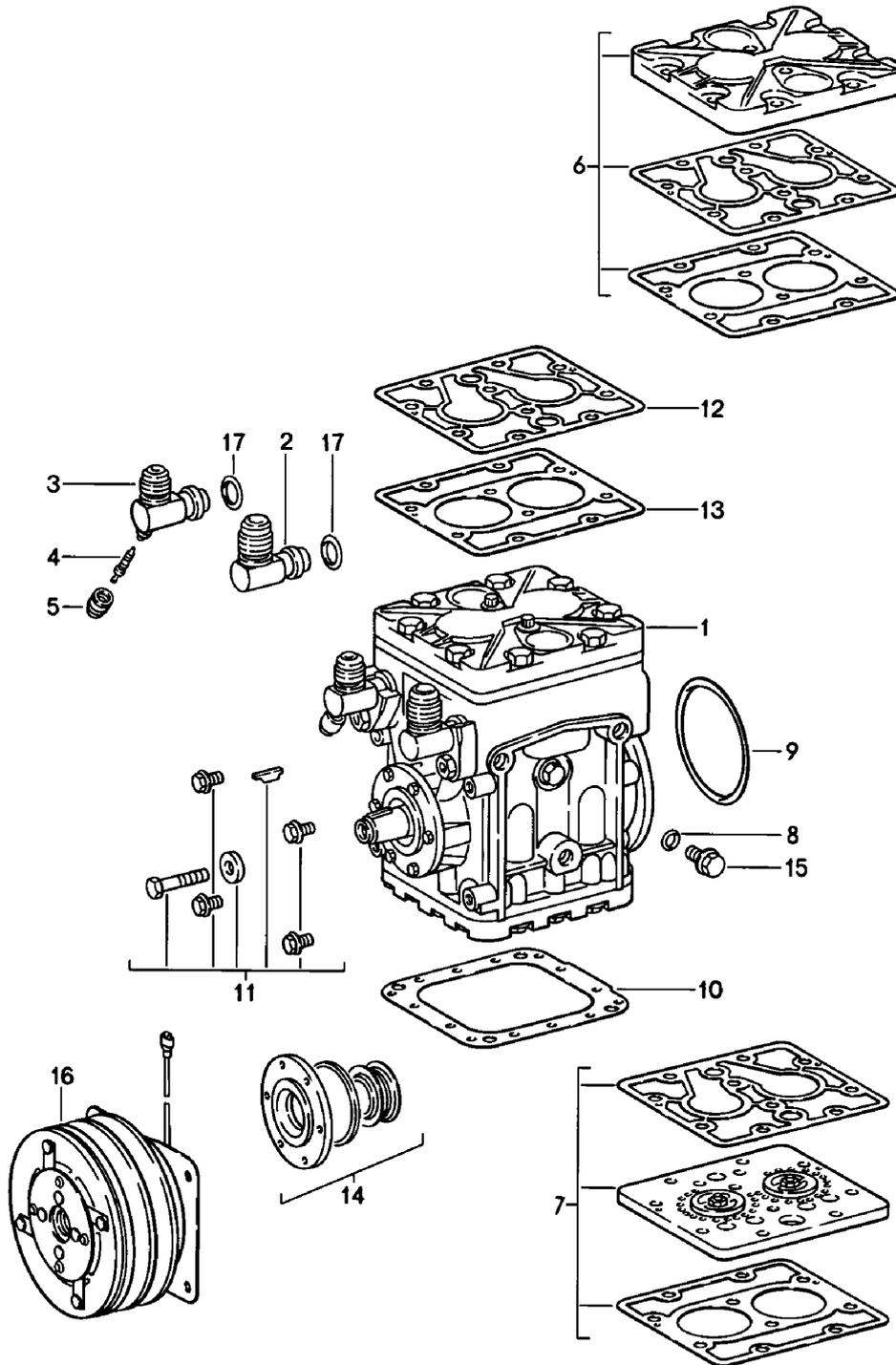

Model: 911 78

Model life 1978>>1983

Pos	Part Number	Description	Remark	Qty	Model
		Supplier YORK			
		Compressor			TURBO
1	930 126 901 00	Compressor		1	
2	930 573 912 00	Suction valve		1	
3	930 573 913 00	Pressure valve		1	
4	928 573 908 03	Valve insert		1	
5	928 573 909 02	Cap		1	
6	930 573 901 00	Lid		1	
		Set			
7	930 573 902 00	Valve plate		1	
		Set			
8	911 126 913 00	O-ring		1	
9	930 573 904 00	Sealing ring		1	
10	930 573 905 00	Gasket		1	
11	911 126 924 00	Compressor		1	
		Clutch			
12	930 573 907 00	Gasket		1	
		Cylinder head			
13	930 573 908 00	Gasket		1	
		Valve plate			
14	911 126 931 00	Parts kit		1	
		Crankshaft			
15	930 573 910 00	Oil filler screw		1	
16	911 126 933 00	Clutch		1	
17	999 701 424 40	Round seal		2	
		15,6 X 1,78			

Model: 911 78

Model life 1978>>1983

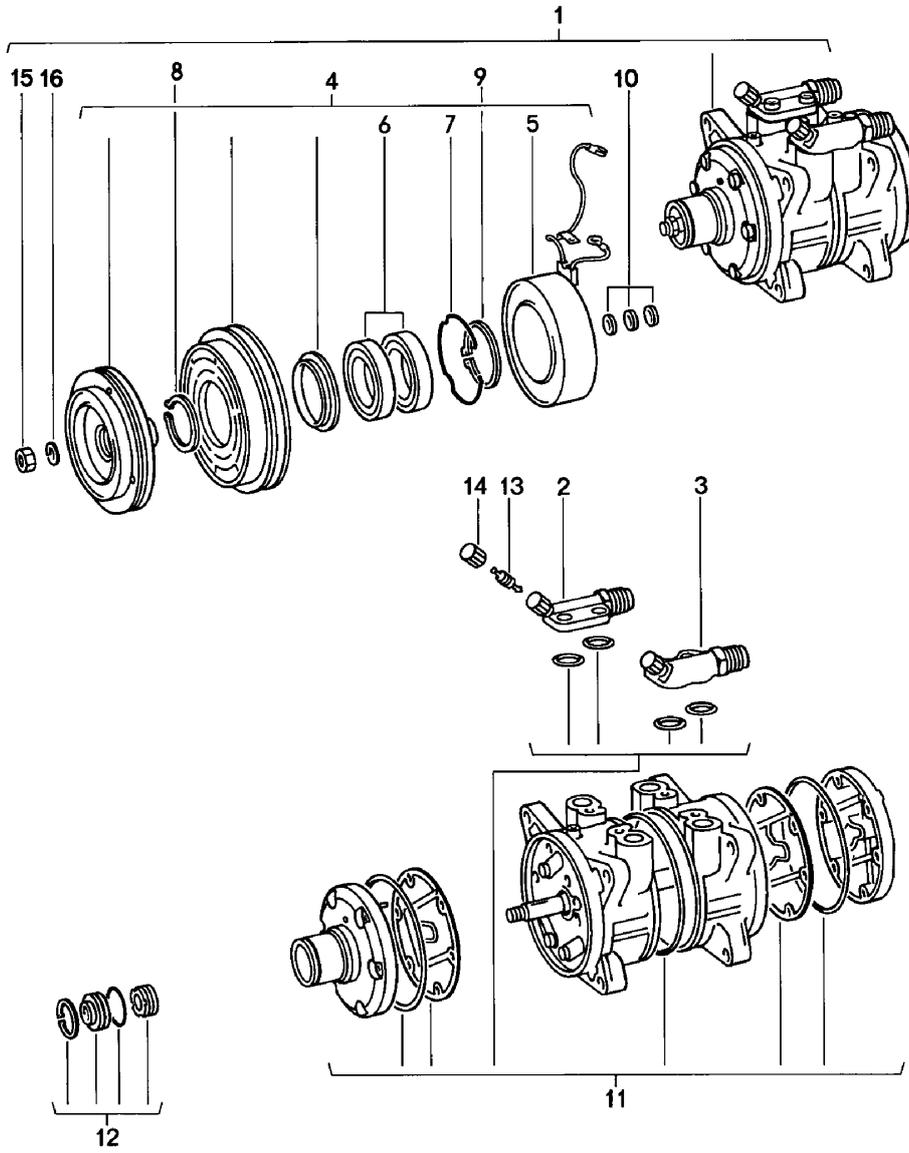

Model: 911 78

Model life 1978>>1983

Pos	Part Number	Description	Remark	Qty	Model
1	930 126 010 00	Supplier NIPPONDENSO Compressor Compressor Complete		1	TURBO
2	477 298 839	Pressure valve		1	
3	477 298 837	Suction valve		1	
4	477 298 823	Clutch		1	
5	477 298 825	Solenoid coil		1	
6	477 298 831	Set of bearings		1	
7	477 298 827	Retaining spring		1	
8	477 298 841	Circlip		1	
9	477 298 843	Circlip		1	
10	477 298 829	Spacer 0,1 MM		X	
(10)	477 298 829 A	Spacer 0,2 MM		X	
(10)	477 298 829 B	Spacer 0,5 MM		X	
(10)	477 298 829 C	Spacer 0,8 MM		X	
(10)	477 298 829 B	Spacer 1,0 MM		X	
11	477 298 833	Gasket set		1	
12	477 298 835	Gasket set		1	
13	928 573 908 03	Valve insert		2	
14	928 573 909 02	Cap		2	
15	N 011 008 8	Hexagon nut M 8		1	
16	900 027 015 02	Lock ring B 8		1	
16	900 027 015 03	Lock ring B 8		1	

Model: 911 78

Model life 1978>>1983

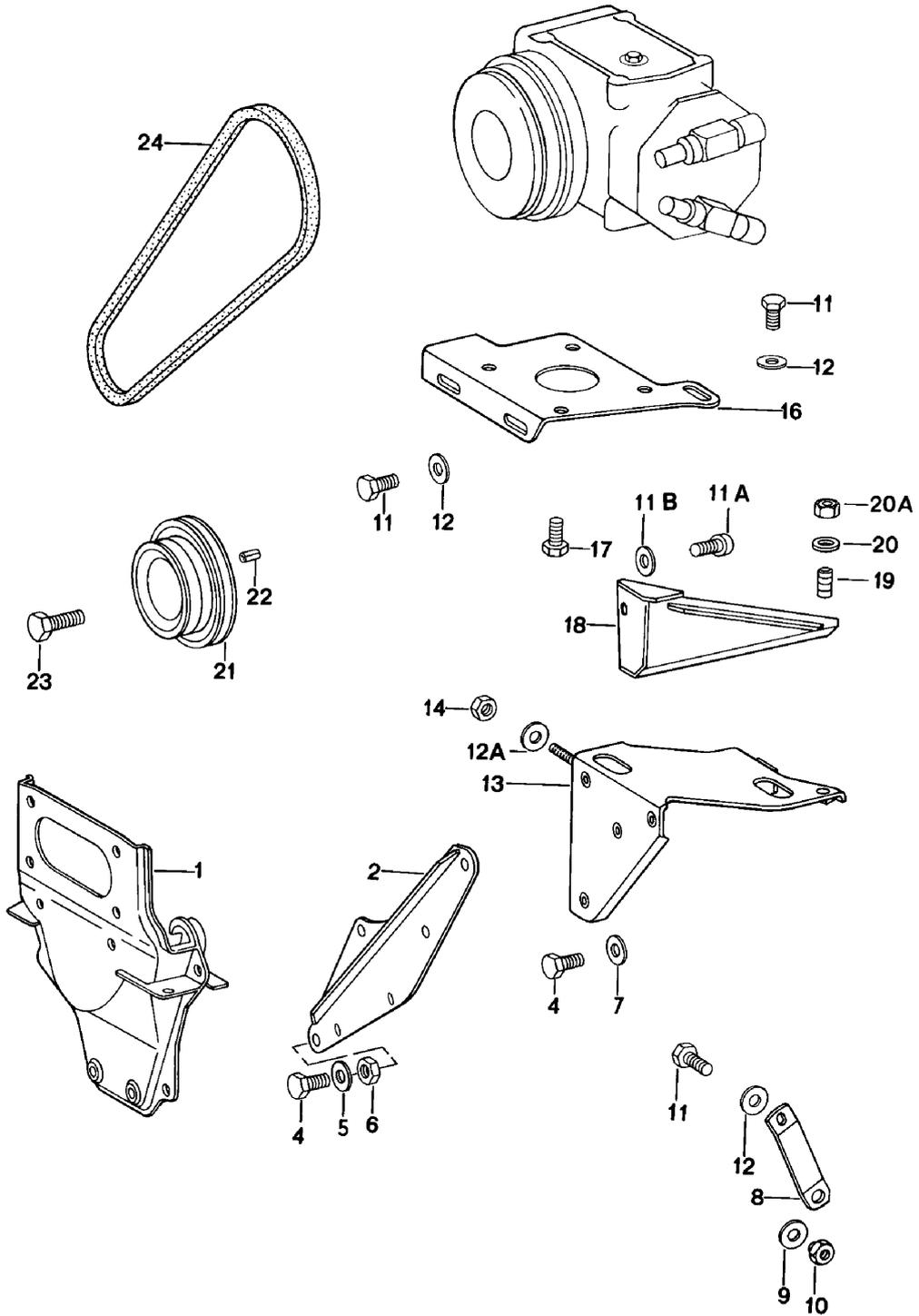

Model: 911 78 Model life 1978>>1983

Pos	Part Number	Description	Remark	Qty	Model
		Supplier YORK Compressor Mounting And Driving mechanism			
1		See group 1/09/00		1	
-		Parts set besteht aus: Träger (13) Kompressorplatte (16) Befestigungswinkel (18)		1	
2	930 126 115 00	Strut		1	SC
(2)	930 126 115 01	Strut		1	TURBO
4	999 075 041 02	Hexagon-head bolt M 10 X 20		4	
5	900 025 008 09	Washer 10,5		2	
5	900 025 008 04	Washer 10,5		2	
6	900 157 002 02	Hexagon nut M 10		2	
6	900 157 002 03	Hexagon nut M 10		2	
7	900 025 008 09	Washer 10,5		2	
7	900 025 008 04	Washer 10,5		2	
8	911 126 124 01	Strut		1	
9	900 031 014 30	Washer 8,4		1	
10	964 126 125 20	Nut		1	
11	900 075 085 02	Hexagon-head bolt	-81	4	SC
11		Hexagon-head bolt M 8 X 20	-81	1	TURBO
(11)	900 119 030 02	Pan-head screw	82-	3	SC
11	900 075 085 02	Hexagon-head bolt M 8 X 20	82-	3	TURBO
(11)	900 075 079 02	Hexagon-head bolt M 8 X 22		3	TURBO
11A	900 119 057 02	Pan-head screw	-81	2	SC
11A		Pan-head screw M 8 X 20	-81	1	TURBO
11A	999 218 004 02	Pan-head screw M 8 X 30	82-	1	
11B	900 025 007 02	Washer 8,4		1	
11B	900 025 007 03	Washer 8,4		1	
12	900 025 007 02	Washer 8,4		6	SC
12	900 025 007 03	Washer 8,4		6	SC
(12)	900 223 001 02	Washer 8,4		6	TURBO
12A		Washer 8,4		1	
13	911 126 101 01	Bracket		1	SC
(13)	930 126 101 02	Bracket		1	TURBO
-	930 126 103 00	Screw M 8 X 25		1	TURBO
-	900 906 007 00	Circlip		1	TURBO

Model: 911 78 Model life 1978>>1983

Pos	Part Number	Description	Remark	Qty	Model
		A 10			
14	900 076 025 02	Hexagon nut		2	SC
14	900 076 064 02	Hexagon nut		2	SC
14	900 076 025 02	Hexagon nut		3	TURBO
		M 8			
14	900 076 064 02	Hexagon nut		3	TURBO
		M 8			
16	911 126 117 01	Compressor plate		1	SC
(16)	930 126 117 02	Compressor plate		1	TURBO
-	900 075 103 02	Adjusting screw		1	TURBO
		M 8 X 50			
17	999 075 021 02	Hexagon-head bolt		4	SC
		3/8"16 UNC - 2AX 3/4"			
(17)	999 075 033 02	Hexagon-head bolt		4	TURBO
		3/8"16 UNC-2AX 3/4"			
18	930 126 116 00	Fastening angle	-81	1	SC
(18)		Fastening angle	-81	1	TURBO
18		Fastening angle	82-	1	
19	999 062 003 02	Stud	-81	2	
		BM 6 X 18			
19	999 062 127 02	Stud	82-	2	
		BM 6 X 25			
-	N 011 666 7	Washer	-81	2	
		6,4			
-	930 126 135 01	Washer	82-	2	
		6,1			
20	999 025 070 02	Washer	-81	2	
		6,4			
20	N 011 666 7	Washer	82-	2	
		6,4			
20A	900 910 096 02	Lock nut		2	
		VM 6			
21		Pulley			
		See group			
		1/02/00			
22		Straight pin			
		See group			
		1/02/00			
23		Hexagon-head bolt			
		See group			
		1/02/00			
24	900 192 027 50	Narrow v-belt		1	SC
24	999 192 305 50	Narrow v-belt		1	TURBO
		Mount			
		Compressor			
		for			
		Charge air cooler			
-	930 126 141 00	Strut		1	
-	930 126 143 00	Spacer		1	
-	N 010 361 4	Hexagon-head bolt		1	
		M 8 X 65			
-	N 010 361 13	Hexagon-head bolt		1	
		M 8 X 65			
-	900 025 008 09	Washer		1	
		10,5			
-	900 025 008 04	Washer		1	
		10,5			
-	999 075 021 02	Hexagon-head bolt		1	
		3/8"16 UNC - 2A X3/4"			

Model: 911 78

Model life 1978>>1983

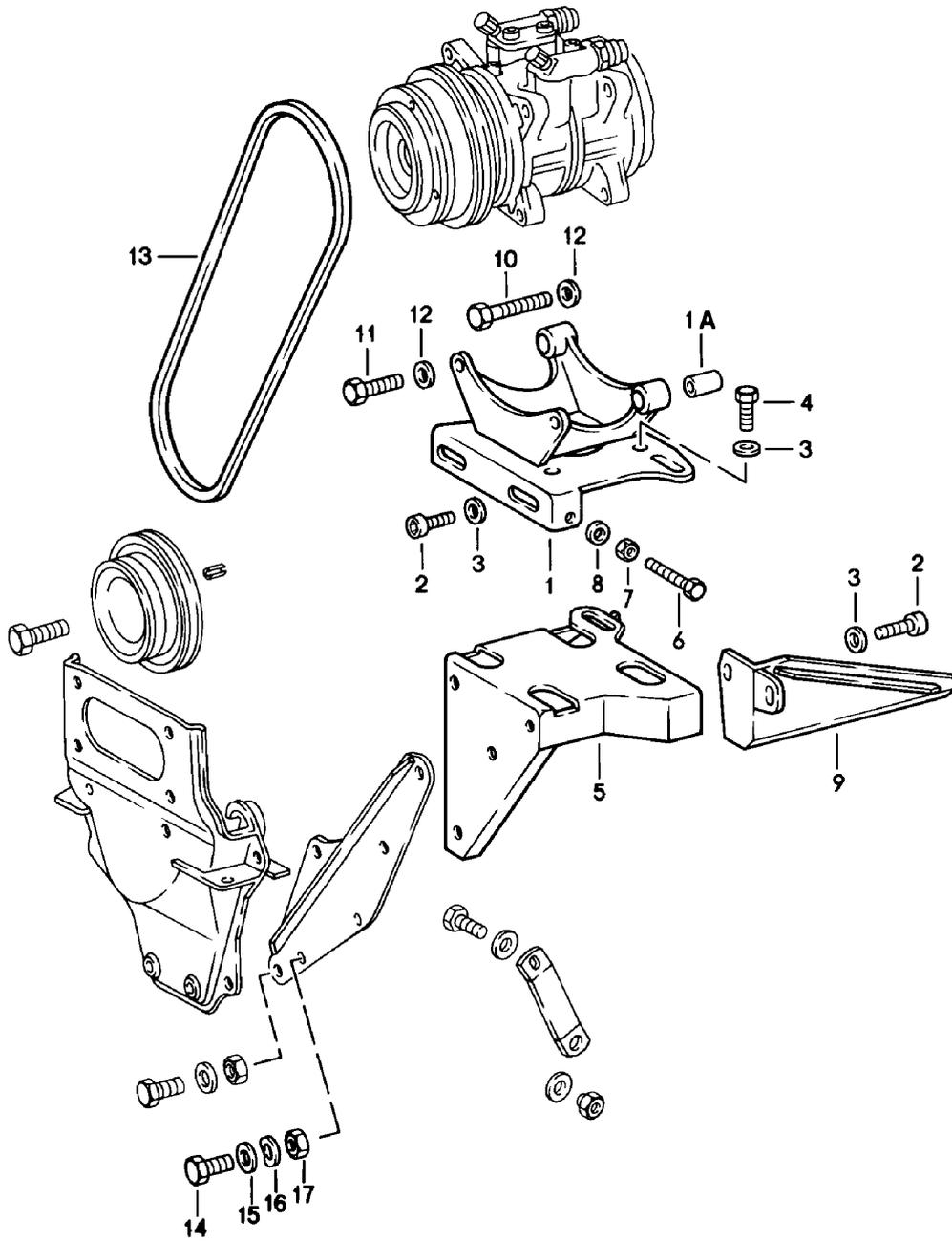

Model: 911 78

Model life 1978>>1983

Pos	Part Number	Description	Remark	Qty	Model
		Supplier NIPPONDENSO			
		Compressor Mounting And Driving mechanism			TURBO
1	930 126 117 04	Compressor plate		1	
1A	930 126 125 00	Guide sleeve		2	
2	900 119 057 02	Pan-head screw M 8 X 20		3	
3	900 223 001 02	Washer 8,4		4	
4	900 075 085 02	Hexagon-head bolt M 8 X 20		1	
5	930 126 101 02	Bracket		1	
6	900 075 103 02	Adjusting screw M 8 X 50		1	
7	900 076 025 02	Hexagon nut M 8		1	
7	900 076 064 02	Hexagon nut M 8		1	
8	900 025 007 02	Washer 8,4		1	
8	900 025 007 03	Washer 8,4		1	
9	930 126 116 00	Fastening angle		1	
10	900 082 088 02	Hexagon-head bolt M 10 X 1,25 X 50		2	
10	900 082 146 01	Hexagon-head bolt M 10 X 1,25 X 50		2	
11	900 083 053 02	Hexagon-head bolt M 10 X 1,25 X 25		2	
12	900 025 008 09	Washer 10,5		4	
12	900 025 008 04	Washer 10,5		4	
13	999 192 173 50	Narrow v-belt		1	
14	900 075 087 02	Hexagon-head bolt M 8 X 16		2	
14	900 075 087 03	Hexagon-head bolt M 8 X 16		2	
15	900 025 007 02	Washer 8,4		2	
15	900 025 007 03	Washer 8,4		2	
16	N 012 229 3	Spring washer A 8		2	
17	900 910 097 02	Lock nut M 8		2	

Model: 911 78

Model life 1978>>1983

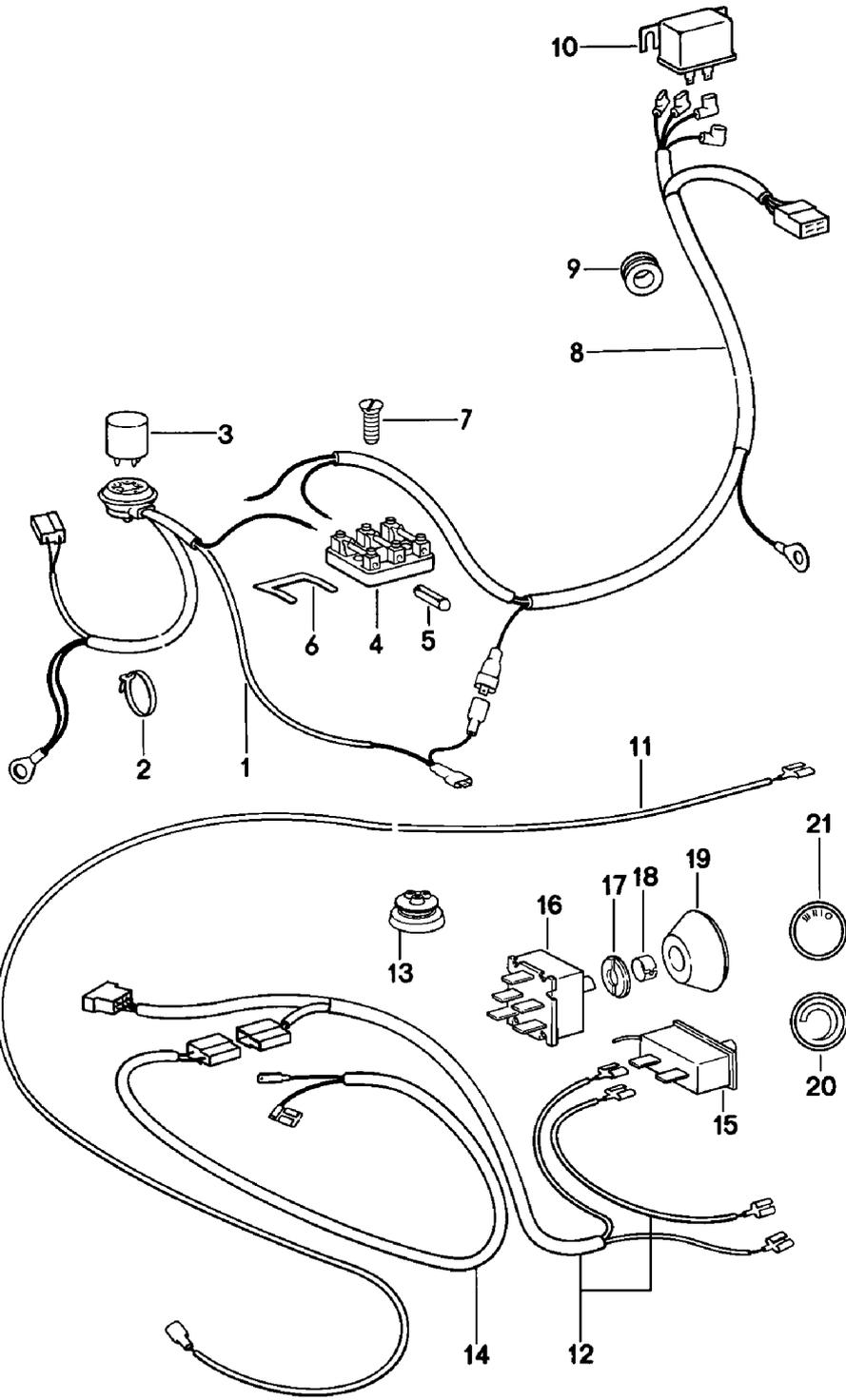

Model: 911 78 Model life 1978>>1983

Pos	Part Number	Description	Remark	Qty	Model
1	911 612 080 01	electrical components for Air conditioner Wiring harness NR. 80		1	M559
(1)	911 612 080 02	Wiring harness NR. 80		1	TURBO M573
2	999 513 008 40	Tie-wrap		1	M559
3	911 615 109 01	Standard type relay		1	M559
4	911 612 093 05	Fuse box Triple		1	
5	N 017 121 5	Lock 25 A		1	
6	901 612 835 01	Connecting rail		1	
7	900 146 009 02	Oval-head screw AM 4 X 12		2	
8	911 612 078 01	Wiring harness NR. 78		1	
9	999 702 119 50	Rubber sleeve		1	
10	911 615 103 01	Relay		1	
11	911 612 079 00	Wiring harness NR. 79		1	
12	911 612 029 01	Wiring harness NR. 29		1	
13	911 612 863 00	Grommet		1	
13	914 571 151 10	Rubber sleeve		1	
14	901 612 084 00	Wiring harness NR. 28		1	
15	911 613 121 01	Temperature switch It is necessary to rework		1	
16	911 613 116 00	Blower switch		1	
17	911 613 119 01	Rosette for POS.16		1	
17	911 613 120 01	Rosette for POS.15		1	
18	999 591 557 01	Knob holder		2	
19	911 613 141 00	Knob		2	
(20)	911 613 237 02	Cap with symbol		1	
(20)	911 613 237 03	Cap with symbol		1	
(21)	911 613 238 02	Cap with symbol		1	

Model: 911 78

Model life 1978>>1983

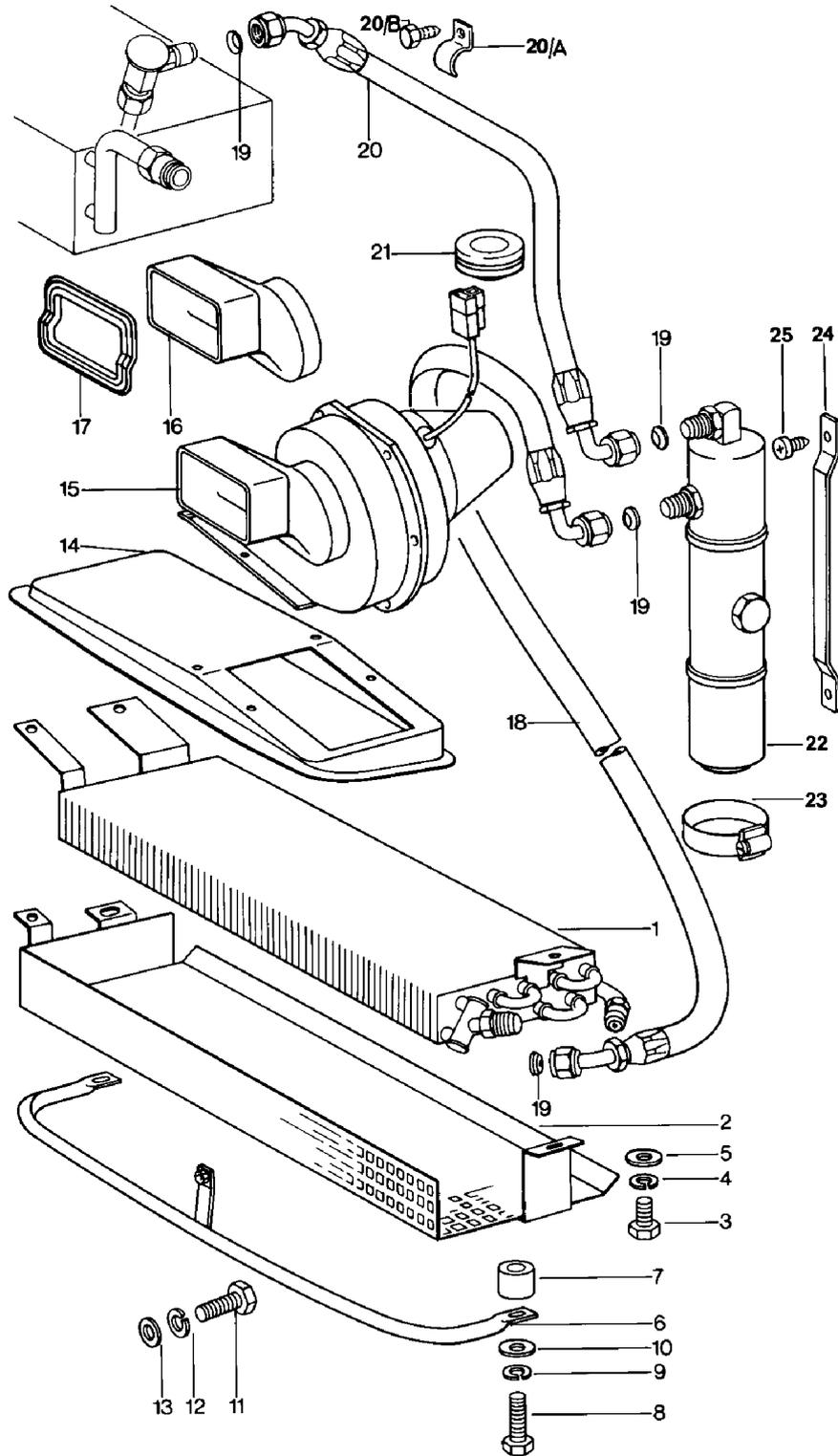

Model: 911 78 Model life 1978>>1983

Pos	Part Number	Description	Remark	Qty	Model
		Condenser Refrigerant line Accessories and others Front			
1	911 573 056 02	Condenser		1	
(2)	911 573 058 01	Stone guard		1	
3	900 075 057 02	Hexagon-head bolt M 6 X 16		3	
3	900 075 057 03	Hexagon-head bolt M 6 X 16		3	
4	N 012 007 2	Lock ring B 6		3	
4	900 027 004 03	Lock ring B 6		3	
5	N 011 524 7	Washer 6,4		3	
5	N 011 524 27	Washer 6,4		3	
6	911 573 055 00	Impact protection		1	
7	911 573 513 01	Spacer		2	
8	N 040 281 1	Hexagon-head bolt M 10 X 45		2	
8	900 075 516 01	Hexagon-head bolt M 10 X 45		2	
9	900 027 016 02	Lock ring B 10		2	
9	900 027 016 03	Lock ring B 10		2	
10	900 151 026 02	Washer B 10,5 X 30		2	
10	900 151 050 01	Washer B 10,5 X 30		2	
11	900 075 085 02	Hexagon-head bolt M 8 X 20		1	
12	900 027 015 02	Lock ring B 8		1	
12	900 027 015 03	Lock ring B 8		1	
13	900 025 007 02	Washer B 8,4		1	
13	900 025 007 03	Washer B 8,4		1	
14	911 501 581 01	Air baffle plate		1	
14	911 501 581 01 GRV	Air baffle plate Prime coated		1	
(15)	911 624 013 01	Blower		1	
16	911 573 161 00	Intake manifold		1	
17	911 573 515 00	Gasket		1	
18	911 573 154 02	Refrigerant hose NW 8		1	
19	901 573 148 00	Gasket 5/8"		4	
(20)	911 573 152 02	Refrigerant hose	/LL	1	
(20)	911 573 152 03	Refrigerant hose	/LL	1	
(20)	911 573 159 00	Refrigerant hose	/RL	1	
20A	999 511 061 02	Clamp		4	
20A	999 511 061 01	Clamp		4	
20B	900 187 025 02	Hexagon-head tapping screw B 5,5 X 13		2	
20B	900 075 145 02	Hexagon-head bolt M 5 X 16		2	
-	N 011 005 14	Hexagon nut M 5		2	

Model: 911 78

Model life 1978>>1983

Pos	Part Number	Description	Remark	Qty	Model
-	900 076 091 01	Hexagon nut M 5		2	
21	901 573 143 00	Rubber sleeve		1	
22	911 573 939 02	Desiccator		1	
-	911 615 152 00	Thermostat		1	M399
23	901 573 141 00	Hose clamp		2	
24	901 573 140 00	Retaining bar		1	
25	900 143 029 02	Oval-head sheetmetal screw B 4,2 X 16		2	

Model: 911 78

Model life 1978>>1983

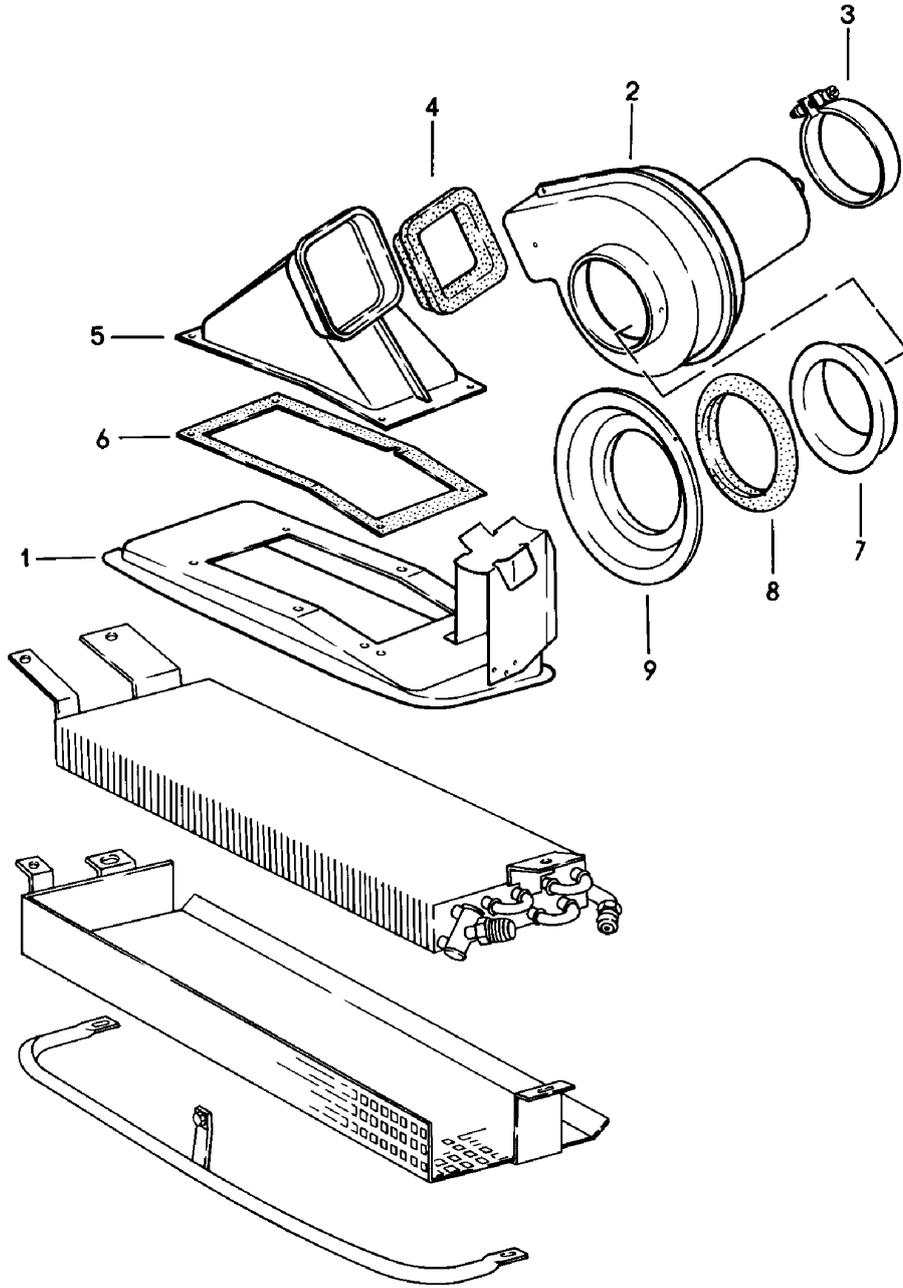

Model: 911 78

Model life 1978>>1983

Pos	Part Number	Description	Remark	Qty	Model
		Fan Front	/RL		M573
1	930 501 057 00	Air baffle plate		1	
1		Air baffle plate		1	
	930 501 057 00 GRV	Prime coated			
2	911 624 151 05	Fan		1	
3	999 512 244 02	Clamp		1	
4	930 573 171 01	Gasket		1	
5	930 573 065 00	Air guide		1	
6	930 573 173 00	Gasket		1	
7	930 573 511 00	Intake manifold		1	
8	930 573 517 01	Gasket		1	
9	930 501 593 00	Insert		1	
9		Insert		1	
	930 501 593 00 GRV	Prime coated			

Model: 911 78

Model life 1978>>1983

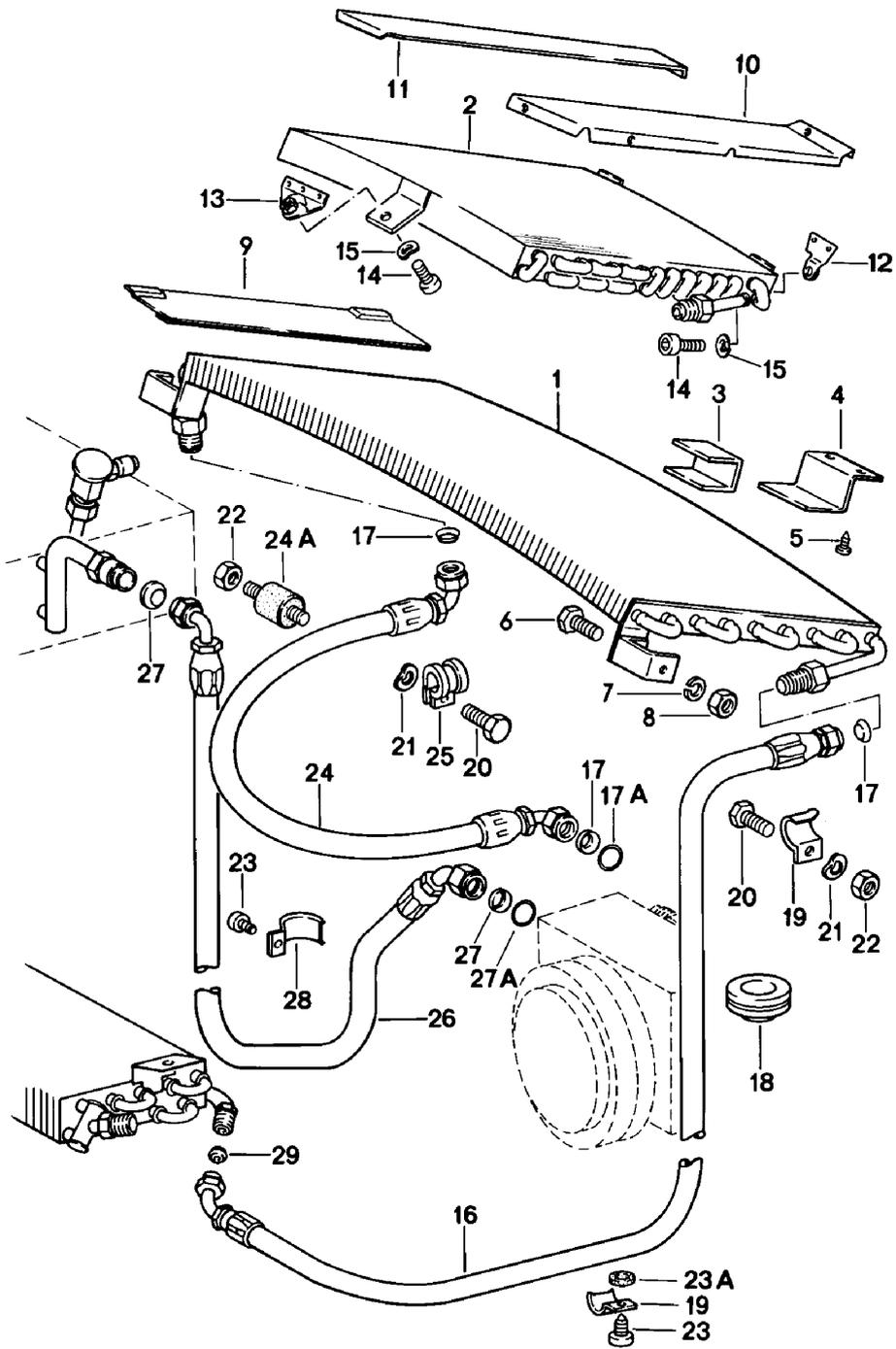

Model: 911 78 Model life 1978>>1983

Pos	Part Number	Description	Remark	Qty	Model
		Condenser Refrigerant line Accessories and others Rear			
1	911 573 057 02	Condenser		1	SC
2	930 573 053 00	Condenser		1	TURBO
3	901 573 138 00	Moltoprene shim 6 X 65 X 85		1	SC
(4)	911 573 147 00	Bracket		1	SC M559
(4)	911 573 059 00	Retaining bar		1	
5	900 143 049 07	Tapping screw B 3,5 X 9,5		2	
6	N 010 204 4	Hexagon-head bolt M 4 X 10	-80	2	
6	900 075 145 02	Hexagon-head bolt M 5 X 15	81-	2	
7	900 027 011 01	Lock ring B 4	-80	2	
(7)	900 025 003 02	Washer A 5,3	81-	2	
8	N 011 004 6	Hexagon nut M 4	-80	2	
8	N 011 004 G	Nut M 4		2	
(8)	999 507 248 02	Speed nut M 5	81-	2	
9	911 573 027 00	Cover plate		2	
10	930 512 263 00	Cover plate		1	TURBO
11	930 512 264 00	Cover plate		1	TURBO
12	930 512 047 01	Support		2	TURBO
13	930 512 258 00	Fastening angle		1	TURBO
14	900 067 008 02	Pan-head screw M 6 X 12		3	TURBO
14	900 067 008 03	Pan-head screw M 6 X 12		3	TURBO
15	N 012 226 5	Spring washer A 6		3	TURBO
(16)	911 573 151 00	Refrigerant hose		1	SC M399
16	911 573 153 03	NW 10, 3280 MM Refrigerant hose		1	SC M559
(16)	930 573 151 01	NW 10 Refrigerant hose		1	TURBO
(16)	930 573 151 04	NW 10 Refrigerant hose		1	TURBO
17	901 573 147 00	Gasket 3/4"		3	
17A	999 707 250 40	O-ring		1	TURBO
17A	999 707 434 41	O-ring		1	TURBO
18	901 573 143 00	Rubber sleeve		1	
18		Rubber sleeve	/RL	3	
19	911 573 144 00	Clamp		18	
(19)	999 511 061 02	Clamp		10	
(19)	999 511 061 01	Clamp		10	
20	N 010 207 6	Hexagon-head bolt M 5 X 12		2	
20	N 010 207 17	Hexagon-head bolt M 5 X 12		2	
20	N 010 209 5	Hexagon-head bolt M 5 X 25		1	TURBO

Model: 911 78 Model life 1978>>1983

Pos	Part Number	Description	Remark	Qty	Model
-	911 573 517 00	Spacer sleeve		2	TURBO
21	N 012 005 3	Lock ring B 5		2	
22	N 011 005 14	Hexagon nut M 5		2	
22	900 076 091 01	Hexagon nut M 5		2	
23	900 187 023 02	Hexagon-head tapping screw B 5,5 X 16		16	
(23)	900 075 145 02	Hexagon-head bolt M 5 X 16		11	
-	900 076 027 02	Nut M 5		11	
-	N 012 005 3	Lock ring B 5		11	
23A	999 704 134 40	Sealing washer		13	
-	901 543 423 00	Edge protection		1	TURBO
24	911 573 150 02	Refrigerant hose NW 10		1	SC
(24)	930 573 150 01	Refrigerant hose	-79	1	TURBO
(24)	930 573 150 03	Refrigerant hose NW 10 for NIPPONDENSO Compressor		1	TURBO
(24)	930 573 150 07	Refrigerant hose NW 10 for NIPPONDENSO Compressor		1	TURBO
24A	999 703 312 00	Bonded rubber buffer \$=15 MM M 5 X 10		1	TURBO
24A	999 703 312 01	Bonded rubber buffer \$=15 MM M 5 X 10		1	TURBO
25	999 511 061 02	Clamp		1	SC
25	999 511 061 01	Clamp		1	SC
25	999 512 080 02	Hose clamp		2	TURBO
(26)	911 573 149 02	Refrigerant hose NW 13		1	SC
(26)	911 573 149 05	Refrigerant hose NW 13		1	SC
(26)	930 573 149 00	Refrigerant hose NW 13	-79	1	TURBO
(26)	930 573 149 01	Refrigerant hose NW 13 for NIPPONDENSO Compressor		1	TURBO
-	911 573 525 01	Refrigerant hose	/RL	1	
27	901 573 146 00	Gasket 7/8"		2	
27A	999 707 251 40	O-ring		1	TURBO
28	911 573 145 00	Clamp		10	
28	911 573 145 01	Clamp		10	
(28)	999 511 080 02	Clamp		2	
29	901 573 148 00	Gasket 5/8"		1	

Model: 911 78

Model life 1978>>1983

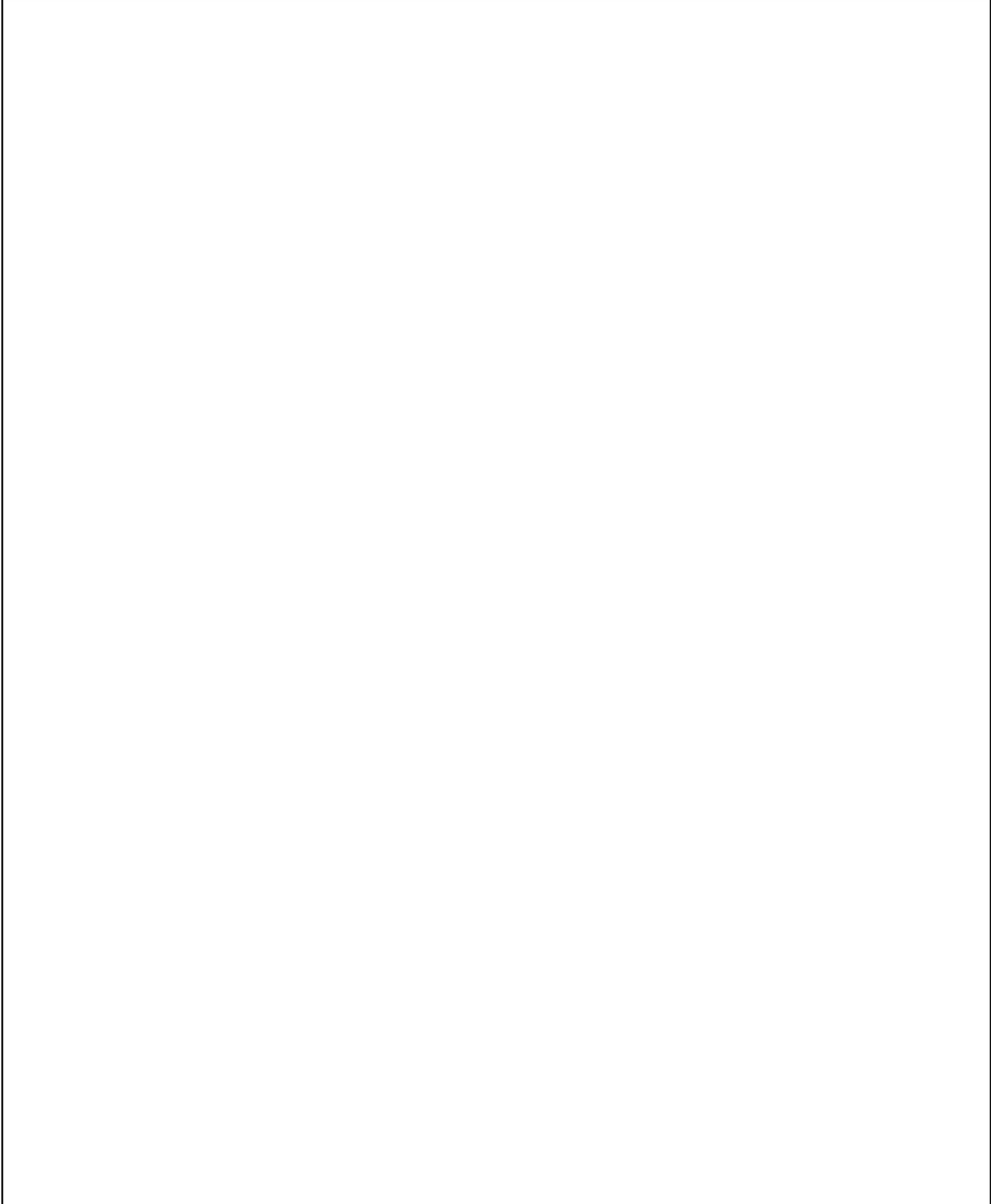

Model: 911 78

Model life 1978>>1983

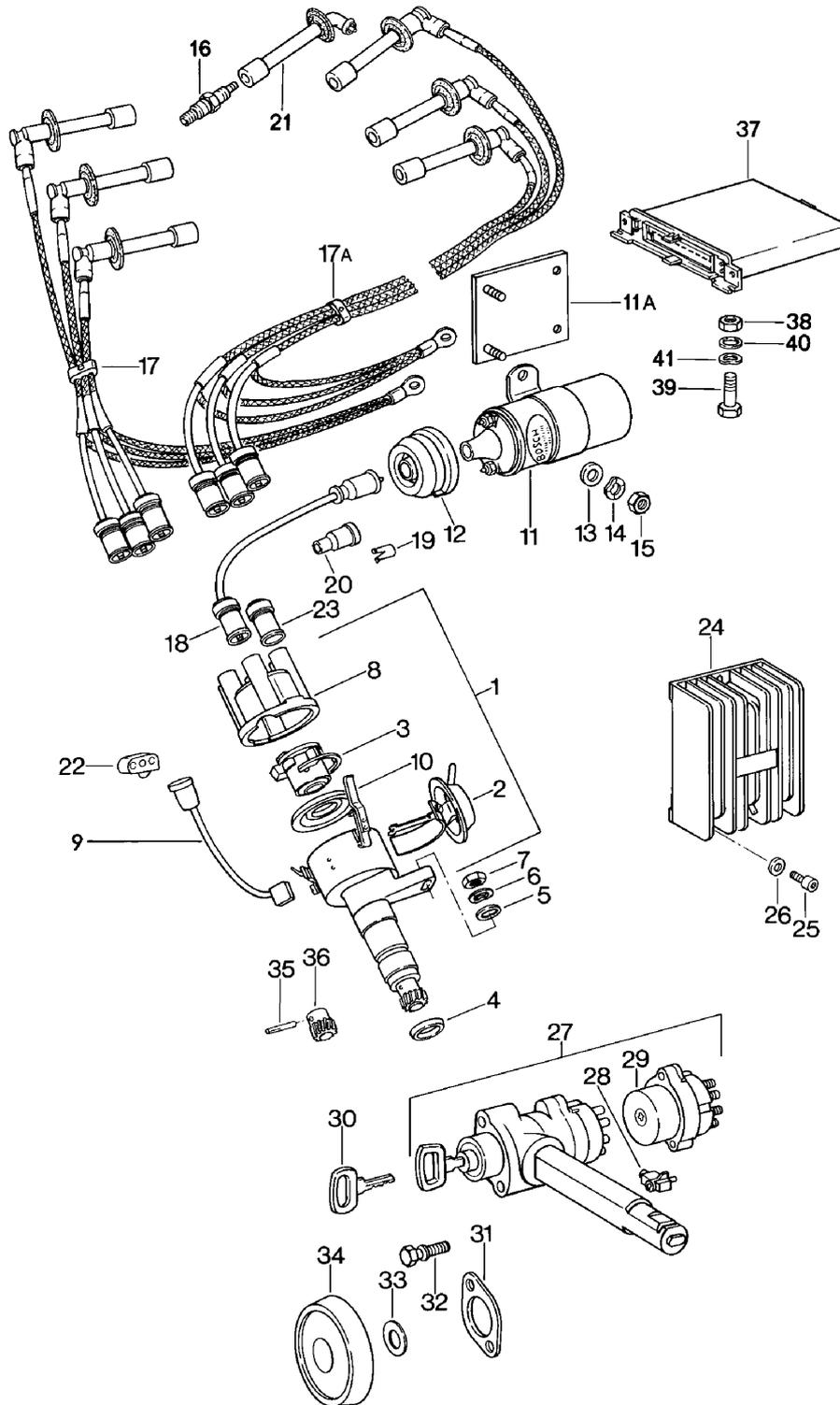

Model: 911 78 Model life 1978>>1983

Pos	Part Number	Description	Remark	Qty	Model
		Engine electrics			
		Steering lock			
1	930 602 021 04	Distributor		1	SC
1	930 602 021 DX	Distributor		1	SC 930.03/09/13 /19
(1)	911 602 021 09	Distributor	81-	1	SC
(1)	911 602 021 JX	Distributor	81-	1	SC 930.10
(1)	930 602 101 06	Distributor		1	TURBO 930.60
(1)	930 602 103 00	Distributor		1	TURBO 930.66
2	930 602 910 00	Vacuum unit		1	SC 930.03/09/13 /19
(2)	930 602 914 00	Vacuum unit		1	TURBO 930.60
(2)	930 602 933 00	Vacuum unit	80-	1	SC 930.10
(2)	930 602 917 00	Vacuum unit		1	TURBO 930.66
3	930 602 901 02	Rotor F.ignition distributor 930.602.021.04/09		1	SC
3	930 602 901 03	Rotor F.ignition distributor 930.602.021.04/09		1	SC
3	930 602 901 04	Rotor F.ignition distributor 930.602.021.04/09		1	SC
(3)	930 602 901 01	Rotor F.ignition distributor 930.602.101.06		1	TURBO
(3)	930 602 901 04	Rotor F.ignition distributor 930.602.101.06		1	TURBO
(3)	930 602 901 03	Rotor F.ignition distributor 930.602.101.06		1	TURBO
(3)	930 602 901 04	Rotor F.ignition distributor 930.602.101.06		1	TURBO
(3)	930 602 901 03	Rotor F.ignition distributor 930.602.101.06		1	TURBO
(3)	930 602 901 04	Rotor F.ignition distributor 930.602.101.06		1	TURBO
4	911 602 102 01	Sealing ring		1	
5	900 025 007 02	Washer B 8,4		1	
5	900 025 007 03	Washer B 8,4		1	
6	N 012 241 8	Spring washer B 8 X 15		1	
7	900 076 025 02	Hexagon nut M 8		1	
7	900 076 064 02	Hexagon nut M 8		1	
8	930 602 904 00	Distributor cap		1	
8	930 602 904 01	Distributor cap		1	
9	930 602 907 01	Electric line		1	

Model: 911 78

Model life 1978>>1983

Pos	Part Number	Description	Remark	Qty	Model
10	930 602 909 00	Dust cover		1	
11	901 602 502 00	Ignition transformer		1	
11A	901 126 121 01	Mounting plate		1	SC M399/559
12	911 602 801 00	Protection cap		1	
13	900 025 007 02	Washer 8,4		2	
13	900 025 007 03	Washer 8,4		2	
14	N 012 241 8	Spring washer B 8 X 15		2	
15	900 076 025 02	Hexagon nut M 8		2	
15	900 076 064 02	Hexagon nut M 8		2	
		Spark plug Use also: 547 09222 for		X	
-	547 09 222	Spark plug Nut for		X	
16	999 170 162 90	Spark plug W 3CC		6	SC
16	999 170 128 90	Spark plug 280 EA 0,6		6	TURBO
17	911 609 011 07	Set of ignition cables geschirmt	/L	1	
17A	911 609 010 07	Set of ignition cables geschirmt	/R	1	
18	911 609 061 07	Ignition lead Distributor Ignition transformer		1	
19	911 609 510 00	Cable plug		1	
19	PCG 609 510 00	Cable plug		1	
20	999 659 001 40	Water protection cap		1	
21	911 602 315 00	Spark plug connector		6	
22	901 609 591 00	Cable holder		4	
23	122 035 281	Suppression connector		7	
24	930 602 702 00	Switch unit		1	
24	930 602 702 X	Control unit		1	
25	N 014 703 2	Pan-head screw M 6 X 18		3	
26	900 031 011 02	Washer 6,4		3	
27	911 613 902 02	Steering lock W/o stipulated lock number		1	
27	911 613 904 02	Steering lock with stipulated lock number		1	
27	964 347 917 00	Steering lock with stipulated lock number		1	
29	911 613 017 01	Ignition starter switch		1	
30		Main key Secondary key See group 8/04/00			
31	911 347 359 01	Tab washer		1	
32	999 219 017 02	Shear bolt		2	
33	911 613 169 00	Washer Cover Steering lock		1	
33	911 613 169 01	Washer		1	

Model: 911 78

Model life 1978>>1983

Pos	Part Number	Description	Remark	Qty	Model
34	911 613 160 00	Cover Steering lock Rosette for Steering lock		1	
-	999 190 123 02	Blind rivet		2	
35	930 602 922 00	Pin		1	
36	930 602 422 02	Pinion Only together with Drive wheel 930.102.115.01		1	911.03/13 930.60/61/62
(36)	930 602 422 90	Special pinion See technical information GR. 2 NR. 19 12.12.1977		1	911.03/13 930.60/61/62

Model: 911 78

Model life 1978>>1983

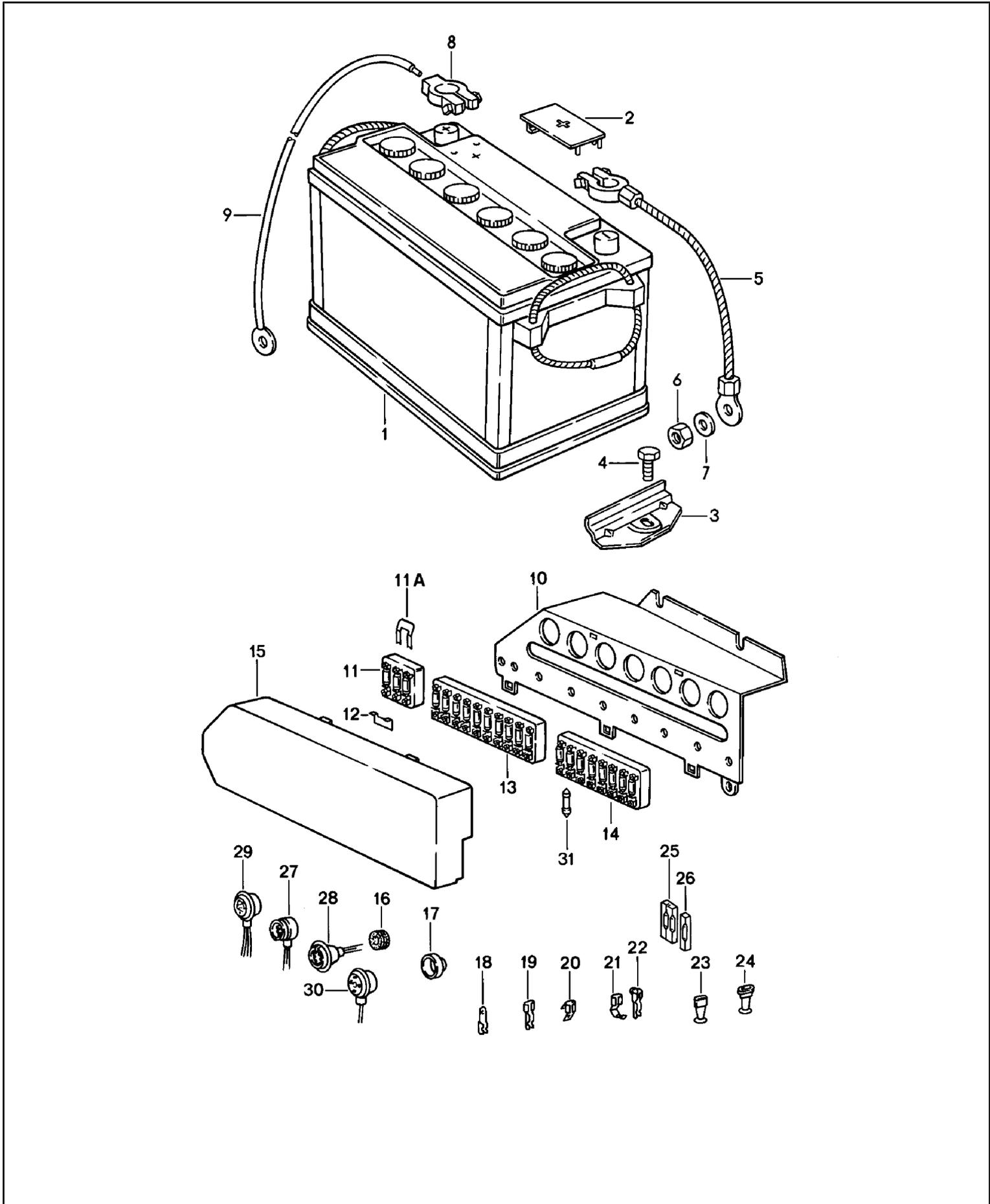

Model: 911 78 Model life 1978>>1983

Pos	Part Number	Description	Remark	Qty	Model
		Battery			
		Fuse box			
1	928 611 101 01	Battery		1	
		12 V 66 AH			
1	928 611 175 02	Battery		1	
		12 V 75 AH			
1	999 611 070 20	Battery		1	
		12 V 70 AH			
1	999 611 070 21	Battery		1	
		12 V 70 AH			
1	999 611 088 20	Battery		1	
		12 V 88 AH			
2	999 611 104 00	Pole covering		1	
3	911 611 209 00	Bracket		1	
4	999 075 032 02	Hexagon-head bolt		1	
		M 8 X 20			
5	911 611 899 00	Ground strap		1	
		Battery			
		Body			
6	900 076 030 02	Hexagon nut		1	
		M 8 X 1			
7	900 025 007 02	Washer		1	
		8,4			
7	900 025 007 03	Washer		1	
		8,4			
8	911 611 898 01	Terminal		1	
8	911 611 898 04	Terminal		1	
9	911 612 022 28	Battery-starter cable		1	
-	900 076 030 02	Hexagon nut		3	
		M 8 X 1			
-	900 025 007 02	Washer		3	
		8,4			
-	900 025 007 03	Washer		3	
		8,4			
10	911 612 197 00	Mounting plate		1	
		Fuse box			
		Relay			
-	911 612 401 00	Spacer		1	
-	900 025 002 02	Washer		2	
		4,3			
-	900 025 002 03	Washer		2	
		4,3			
-	900 143 076 02	Oval-head sheetmetal screw		1	
		4,2 X 25			
11	911 612 093 03	Fuse box		1	
		3-pole			
-	900 146 009 02	Oval-head screw		2	
		4 X 12			
11A	901 612 835 01	Connecting rail		1	
12		Connecting rail		2	
13	911 612 086 01	Fuse box		1	
		10-pole			
14	911 612 087 01	Fuse box		1	
		8-pole			
-	900 146 009 02	Oval-head screw		4	
		4 X 12			
-	999 507 401 40	Special nut		2	
(15)	911 612 161 04	Lid		1	SC
(15)	930 612 161 02	Lid		1	TURBO
16	999 702 051 50	Grommet		1	
17	911 611 921 00	Rubber boot		1	
19	111 971 959	Flat receptacle		X	
		with			

Model: 911 78 Model life 1978>>1983

Pos	Part Number	Description	Remark	Qty	Model
(19)	PCG 971 959	Clip 6,3 X 0,8 Flat receptacle without Clip 6,3 X 1,0 SN		X	
(19)	999 652 106 02	Flat receptacle		X	
(19)	N 017 491 8	Flat receptacle		X	
(19)	N 017 494 3	Flat receptacle		X	
20	999 652 122 10	Multiple plug connector		X	
23	999 652 119 40	Connector housing for Flat plug		X	
25	999 652 142 40	Push-on connector 2-pole		X	
26		Push-on connector Single pole		X	
27	901 612 330 00	Multiple plug connection 6-pole		X	
29	901 612 333 00	Plug socket Standard type relay		X	
30	901 612 334 00	Plug socket Flasher relay		X	
31	N 017 121 1	Safety fuse 8 AMP.		X	
31	N 017 121 5	Lock 25 AMP.		X	
31	N 017 121 4	Lock 16 AMP.		X	
(31)	900 173 006 90	Safety fuse 5 AMP.		X	
-	911 617 106 00	Diode Windscreen heating Together with Rear window heating	-80	1	
-	999 652 106 02	Flat receptacle Windscreen heating		1	
-	999 652 246 10	Cable shoe Windscreen heating		1	
-	999 652 225 10	Cable shoe Windscreen heating		1	

Model: 911 78

Model life 1978>>1983

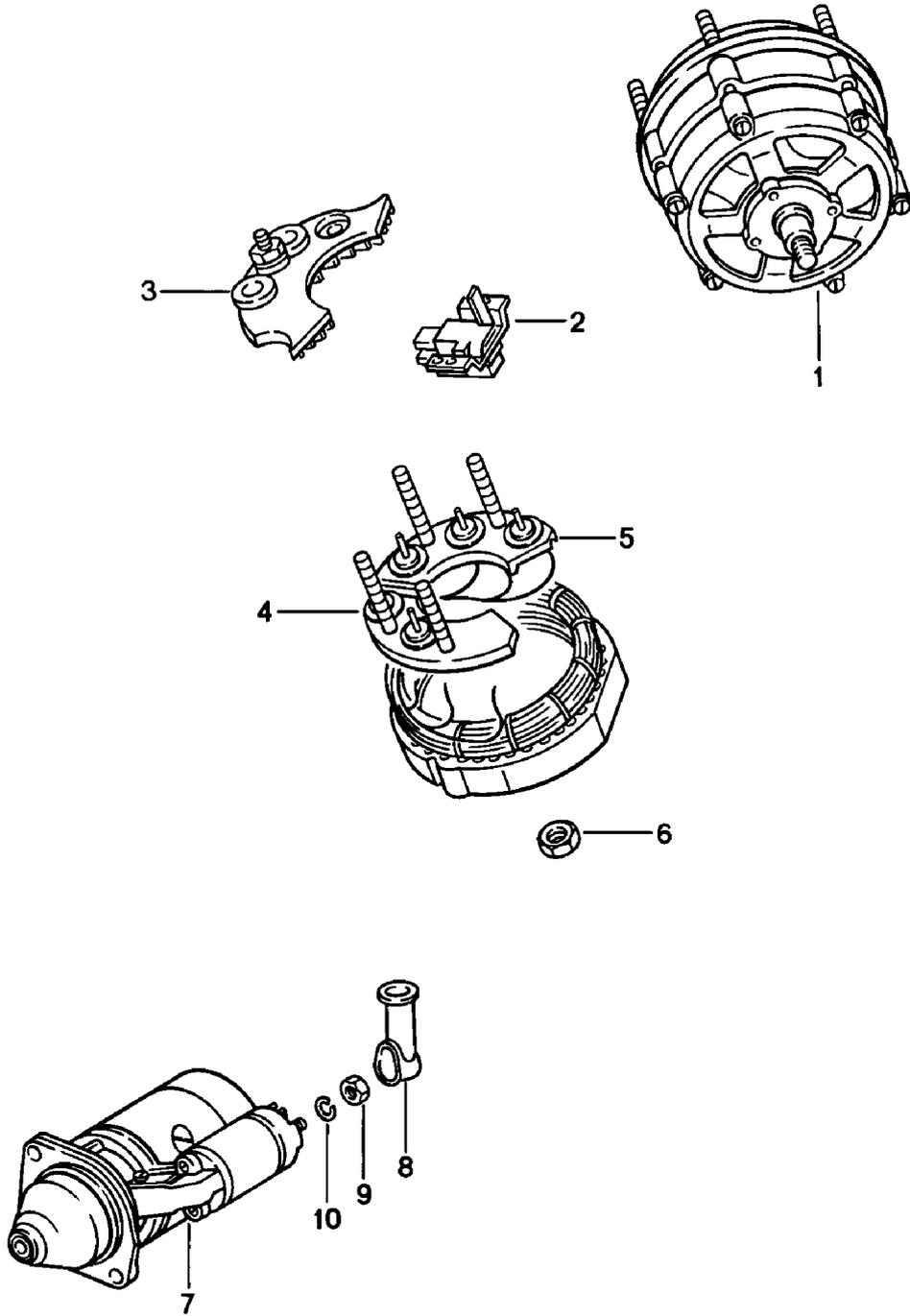

Model: 911 78 Model life 1978>>1983

Pos	Part Number	Description	Remark	Qty	Model
		Generator Starter See technical information GR.2 , NR.28 , 11/81 See TPI GR.9 , NR.13 , 09/94			
1	911 603 120 02	Generator	-81	1	
1	911 603 120 04	Generator	82-	1	
1	911 603 120 DX	Generator	82-	1	
1	911 603 120 HX	Generator	82-	1	
-	900 910 009 02	Lock nut VM 5	82	2	
-	900 084 026 01	Lock nut VM 5	82-	2	
-	N 011 005 14	Hexagon nut M 5	83-	2	
-	900 076 091 01	Hexagon nut M 5	83-	2	
-	900 076 010 02	Nut M 6	82-	1	
-	900 076 010 0B	Nut M 6	82-	1	
-	911 641 981 00	Resistor	82-	1	
-	111 971 511	Line distributor	82-	2	
2	901 603 907 00	Support	-81	1	
(3)	911 603 908 00	Support Diode group 980 W	-81	1	
-	928 603 910 00	Diode plate for 911.603.120.04		1	
4	911 603 909 00	Support Diode group (-) 980 W	-81	1	
5	911 603 910 00	Support Diode group (+) 980 W	-81	1	
6	901 603 905 00	Hexagon nut M 16 X 1	-81	1	
6	901 603 905 01	Hexagon nut M 16 X 1		1	
6	928 603 904 00	Set of fastening parts M 17 X 1,5		1	
-	911 603 913 01	Electronic regulator	82-	1	
-	911 612 233 00	Ground strap Generator Crankcase		1	
7	916 604 101 00	Starter 1,5 KW		1	
7	916 604 101 X	Starter 1,5 KW		1	
7	916 604 101 BX	Starter 1,5 KW		1	
8	999 659 006 50	Protection cap		1	
9	N 011 132 2	Hexagon nut M 8		1	
10	900 027 015 02	Lock ring B 8		1	
10	900 027 015 03	Lock ring B 8		1	

Model: 911 78

Model life 1978>>1983

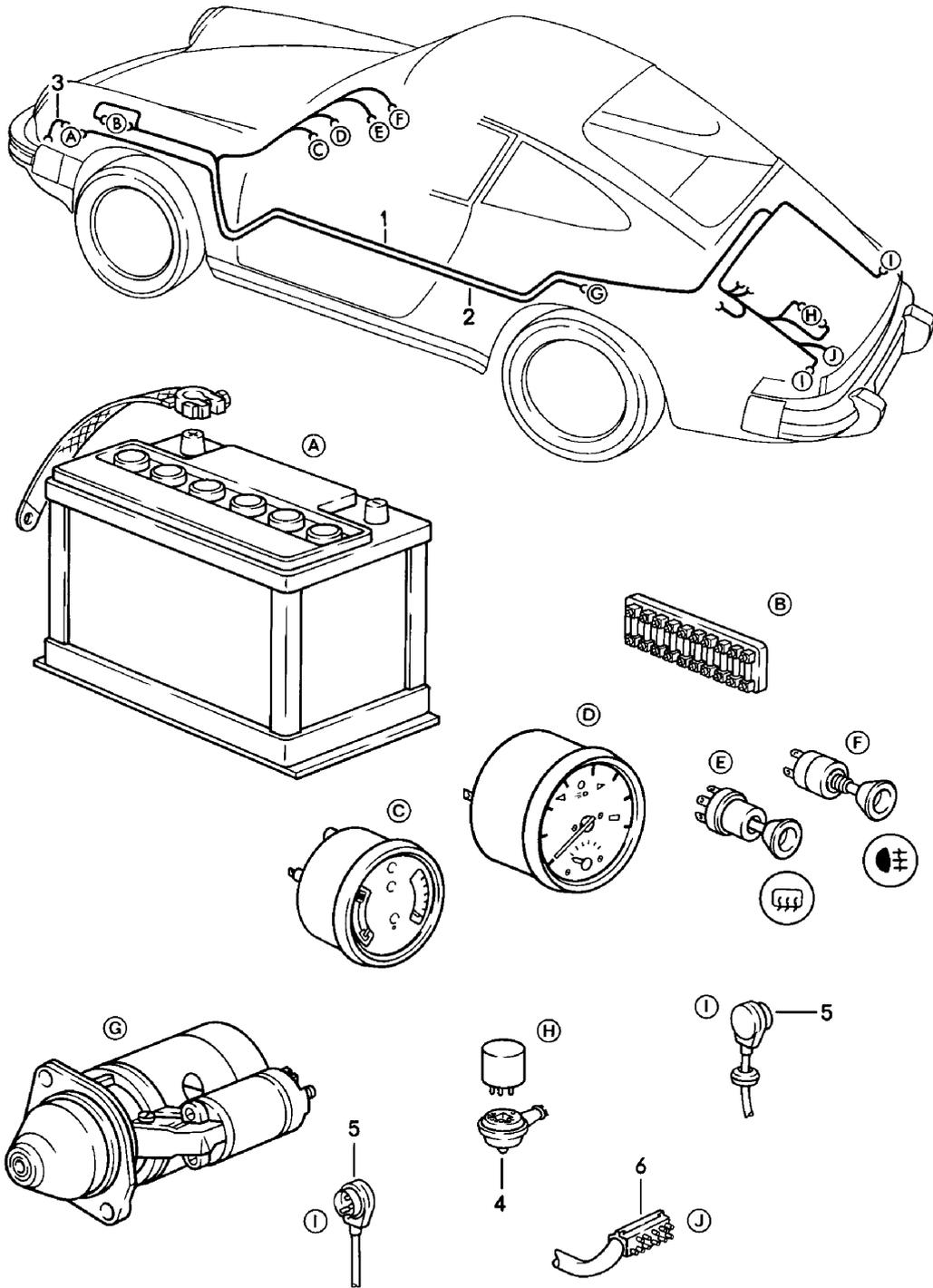

Model: 911 78 Model life 1978>>1983

Pos	Part Number	Description	Remark	Qty	Model
1	911 612 001 30	Wiring harnesses Wiring harness Tunnel	/LL	1	SC
1	930 612 001 06	Wiring harness Tunnel	/LL	1	TURBO
1	911 612 061 27	Wiring harness Tunnel	/RL	1	SC
1	930 612 061 06	Wiring harness Tunnel	/RL	1	TURBO
(2)	911 612 022 28	Battery-starter cable		1	
-	901 612 107 00	Ground strap for Bonnet Mounting parts		2	
-	999 513 002 40	Tie-wrap		1	
-	N 020 910 4	Tie-wrap		1	
-	999 513 003 40	Tie-wrap		1	
-	999 702 132 50	Rubber sleeve		1	
-	999 513 023 40	Tie-wrap		5	
-	911 612 821 00	Covering		1	
3	911 611 899 00	Ground strap Battery		1	
-	999 611 920 20	Ground strap Transmission		1	
4	901 612 333 00	Plug socket Standard type relay		1	
5	901 612 330 00	Multiple plug connection Tail light housing		2	
6	911 612 113 05	Connector housing 14-pole		1	

Model: 911 78

Model life 1978>>1983

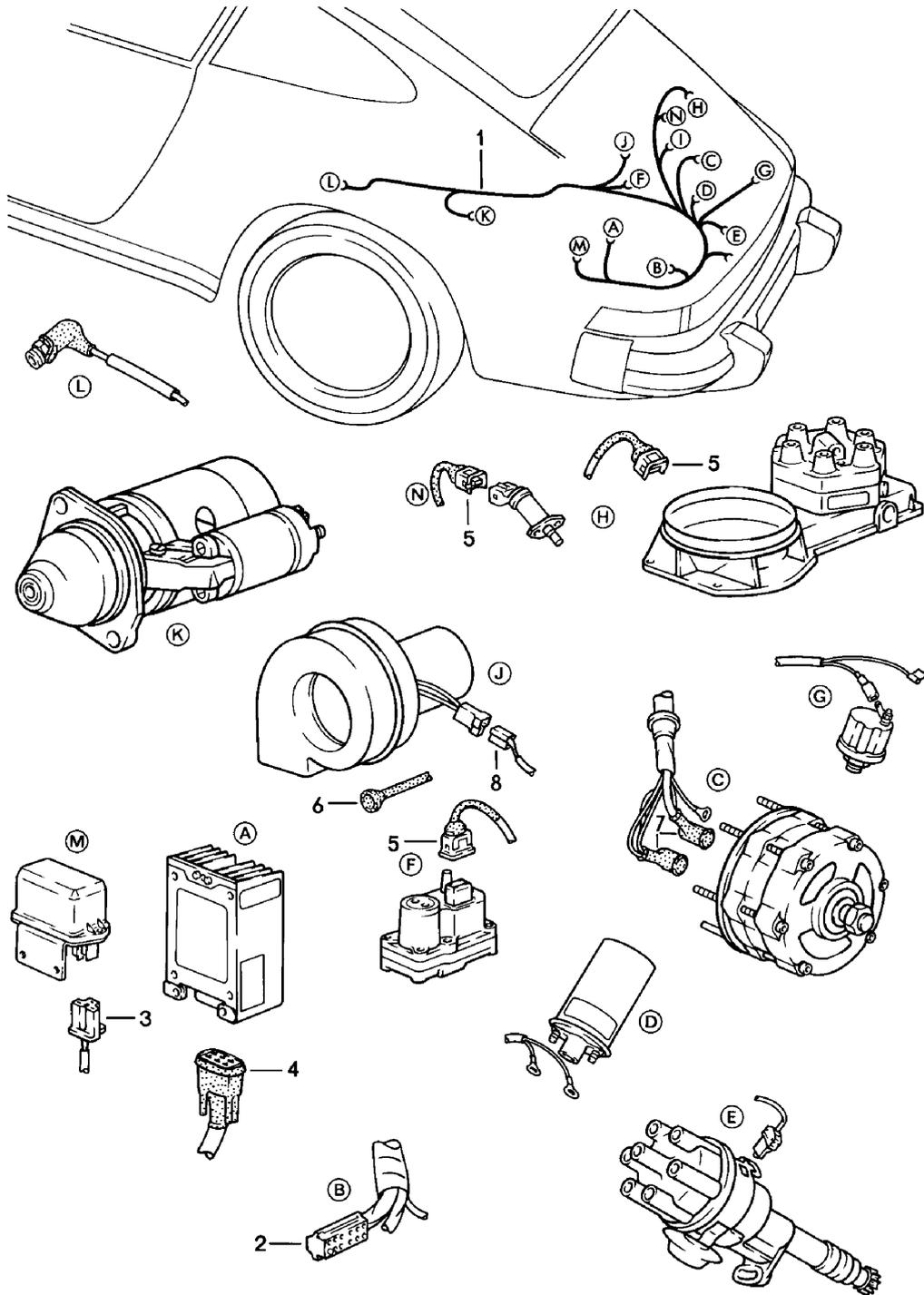

Model: 911 78 Model life 1978>>1983

Pos	Part Number	Description	Remark	Qty	Model
1	911 612 016 03	Wiring harnesses Engine Wiring harness	-81	1	SC
(1)	911 612 016 04	Wiring harness Engine	82-	1	SC
(1)	911 612 012 02	Wiring harness Engine		1	SPM
(1)	930 612 016 05	Wiring harness Engine	-81	1	TURBO
(1)	930 612 016 06	Wiring harness Engine	82-	1	TURBO
-	911 612 907 00	Contact pin for Back-up light switch		2	
-	911 612 907 01	Contact pin for Back-up light switch		2	
2	911 612 115 03	Connector housing 14-pole		1	
5	022 906 231 A	Connector housing		1	
6	022 906 102	Protection cap		1	
7	999 659 033 50	Rubber cap		2	
-	999 911 041 00	Edge protection		*	
8	999 652 167 40	Terminal sleeve housing		1	
-	914 613 491 00	Protection cap Temperature switch		1	
-	911 612 233 00	Ground strap Generator Crankcase		1	
-	999 511 118 02	Pipe clamp for Wiring harness		1	
-	999 511 118 01	POS. 1 Pipe clamp for Wiring harness		1	
-	911 612 091 01	POS. 1 Wiring harness Luggage compartment		1	
-	171 971 998	Connector housing Luggage compartment		1	

Model: 911 78

Model life 1978>>1983

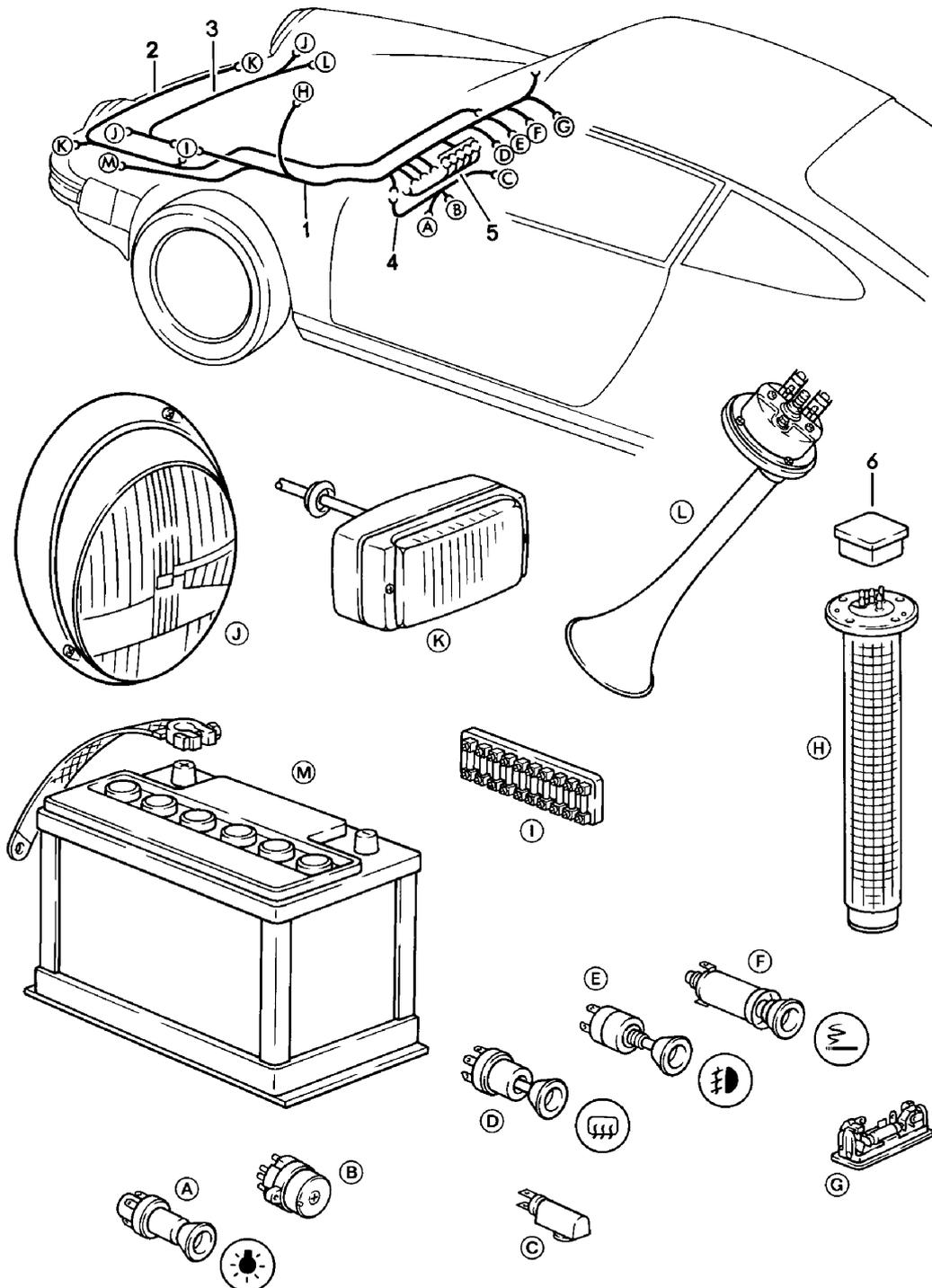

Model: 911 78 Model life 1978>>1983

Pos	Part Number	Description	Remark	Qty	Model
1	911 612 002 14	Wiring harnesses Luggage compartment Steering lock Wiring harness	/LL	1	
1	911 612 060 04	Luggage compartment Wiring harness	/RL	1	
2	911 612 027 03	Luggage compartment Additional cables Fog headlamp		1	
-	911 612 027 01	Ground cable Fog headlamp		1	
3	911 612 003 01	Wiring harness Fuse box Headlamp Horn		1	
-	113 941 189	Grommet Rubber Headlamp casing		X	
4	911 612 011 32	Wiring harness Steering lock		1	
5	911 612 047 00	Wiring harness Instruments Illumination		1	
-	911 612 177 01	Wiring harness Direction indicator light		1	
-	477 953 331	Grommet Direction indicator light		2	
-	911 612 010 03	Wiring harness Light switch		1	
-	930 612 091 00	Single line Indicator light Generator Diode		1	TURBO
-	111 971 977	Flat connector socket Diode Single line 930.612.091.00		1	TURBO
-	911 617 108 00	Diode Indicator light Generator		1	TURBO
-	911 617 108 01	Diode Indicator light Generator		1	TURBO
-	901 612 043 01	Use also: 825.971.990 Positive cable Oil temperature Instrument		1	SPM
-	911 612 083 00	Ground cable Ashtray light		1	
-	901 612 303 20	Ground strap Connection piece Fuel tank		1	
-	911 612 014 30	Wiring harness Hazard warning light sw.		1	
-	911 612 091 02	Wiring harness Switch Fog headlamp	(CH) 81-	1	
-	901 612 064 00	Ground cable Switch Fog headlamp		1	
6	901 612 891 01	Connector housing		1	

Model: 911 78

Model life 1978>>1983

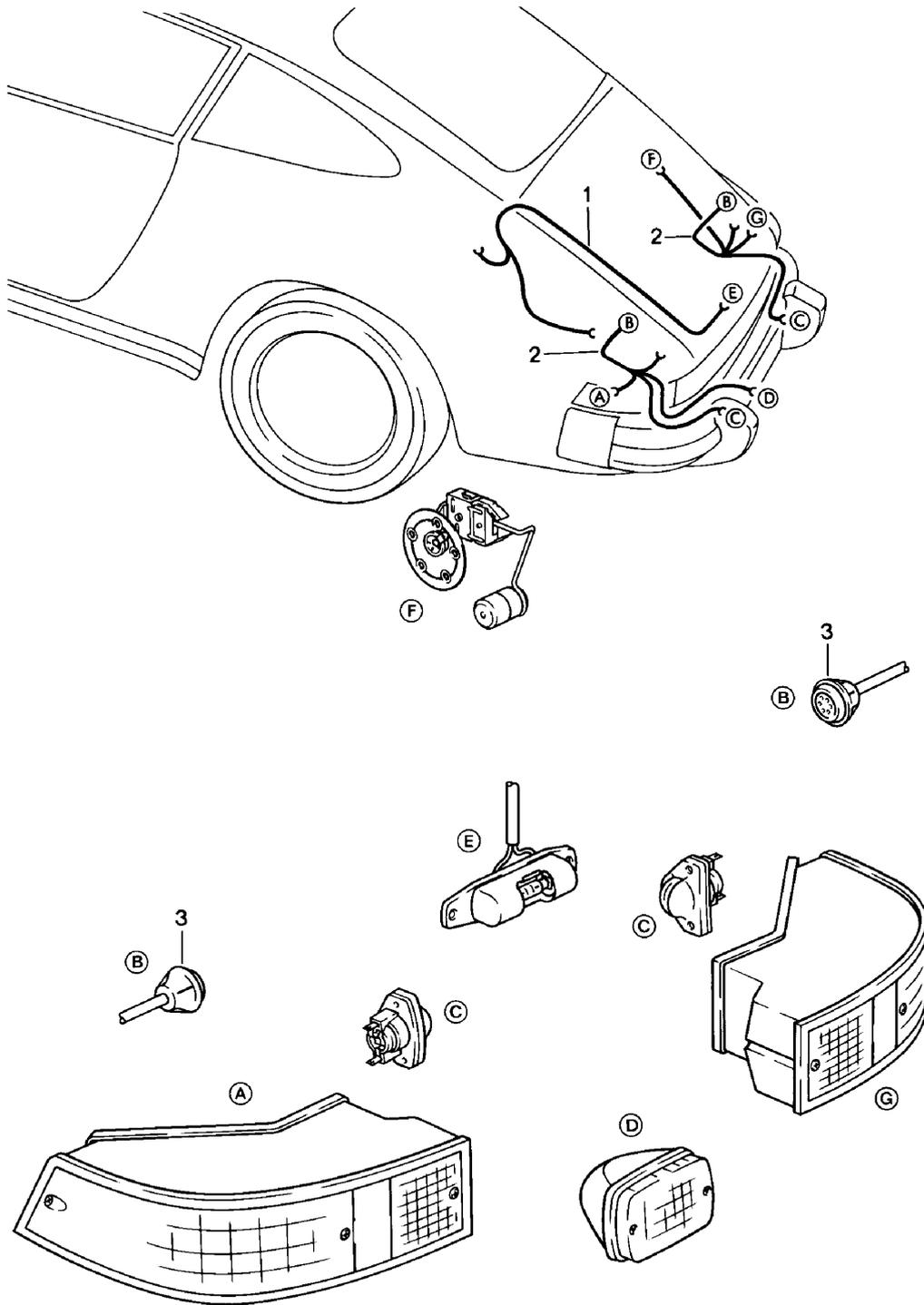

Model: 911 78

Model life 1978>>1983

Pos	Part Number	Description	Remark	Qty	Model
1	911 612 049 00	Wiring harnesses Rear end Wiring harness Engine compartment lamp		1	
2	911 612 039 01	Wiring harness Rear light	/R	1	
2	911 612 039 10	Wiring harness Rear light	/L	1	
-	911 612 026 00	Wiring harness Switch for rear fog light Fuse box		1	
-	901 612 066 02	Wiring harness Switch for rear fog light		1	
-	911 612 091 02	Wiring harness Fog headlamp	(CH) 81-	1	
-	901 612 064 00	Ground cable Switch Fog headlamp And		1	
-	911 612 154 00	Rear fog light Wiring harness	/RL	1	
-	911 612 155 01	Wiring harness - 2 - Rear fog light		1	
3	901 612 330 00	Multiple plug connection		1	

Model: 911 78

Model life 1978>>1983

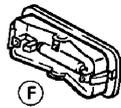
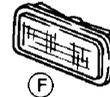
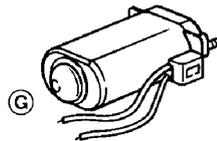
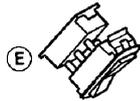
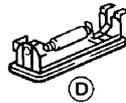
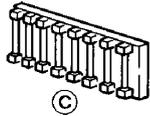
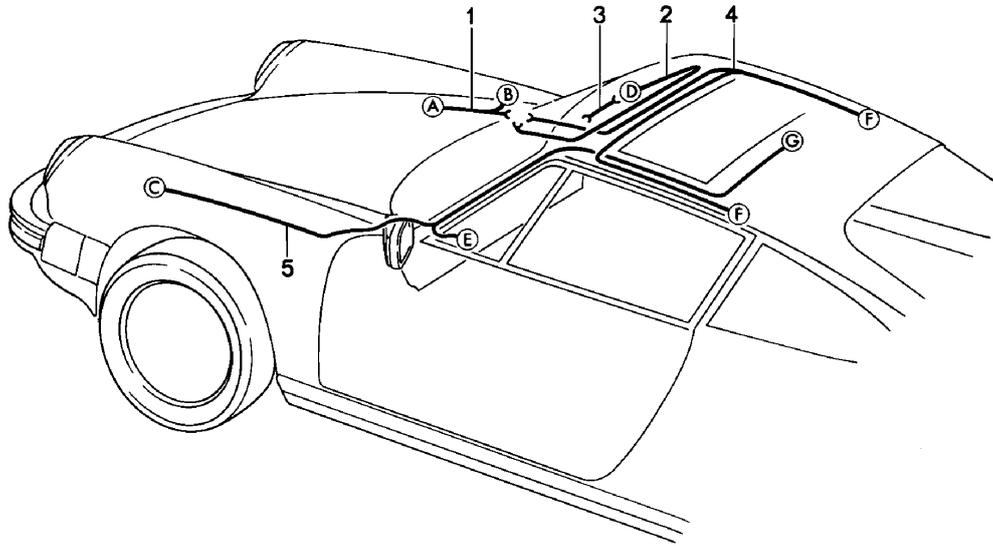

Model: 911 78 Model life 1978>>1983

Pos	Part Number	Description	Remark	Qty	Model
		Wiring harnesses FRONT luggage compartment Interior lights Sunroof			
1	911 612 044 21	Wiring harness		1	
		Luggage compartment lamp			
2	901 612 035 41	Wiring harness		1	TARGA
		Interior light			
3	911 612 226 00	Ground strap		1	TARGA
		Interior light			
4	901 612 035 20	Wiring harness		1	COUPE
		Interior lights			
5	911 612 034 00	Wiring harness	/LL	1	
		Sunroof			
(5)	911 612 064 01	Wiring harness	/RL	1	
		Sunroof			
-	999 613 017 40	Covering		*	
		Cable holder			
-	911 612 415 00	Wiring harness	81-	1	
		Switch			
		Interior light			

Model: 911 78

Model life 1978>>1983

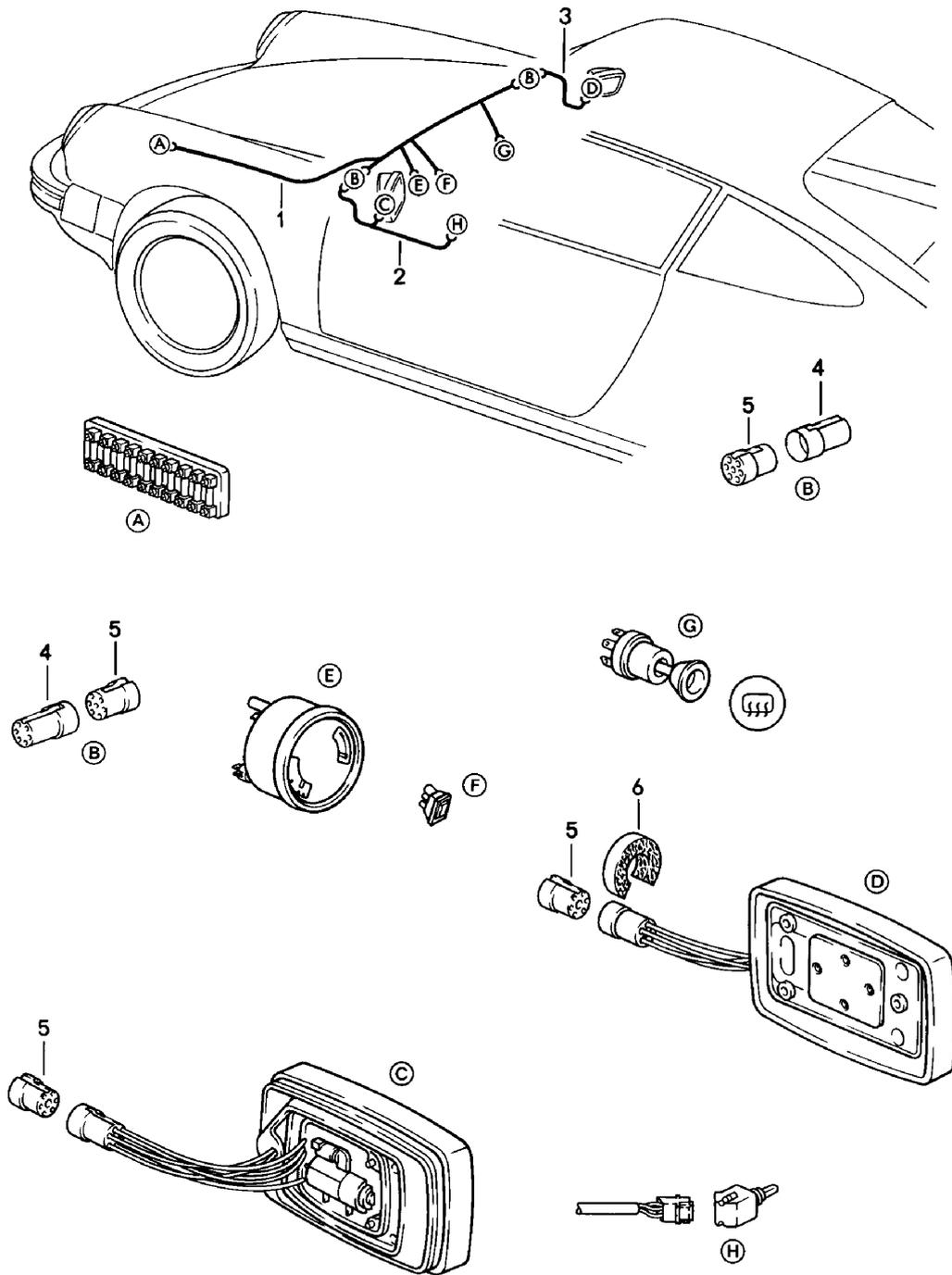

Model: 911 78

Model life 1978>>1983

Pos	Part Number	Description	Remark	Qty	Model
		Wiring harnesses			
		Door mirror			
		Door mirror			
		- 1 -			
1	911 612 162 03	Wiring harness	/LL	1	
(1)	911 612 162 02	Wiring harness	/RL	1	
2	911 612 163 01	Wiring harness		1	
(4)	911 612 890 00	Plug socket 3-pole		1	
5	803 971 979	Plug socket 7-pole		1	
		Door mirror			
		- 2 -			
1	911 612 164 03	Wiring harness	/LL	1	
(1)	911 612 164 02	Wiring harness	/RL	1	
2	911 612 165 01	Wiring harness		1	
		Driver's side			
3	911 612 166 01	Wiring harness		1	
		Passenger's side			
4	803 971 980	Pin connector socket 7-pole		2	
5	803 971 979	Plug socket 7-pole		4	
6	911 731 317 00	Seal		2	

Model: 911 78

Model life 1978>>1983

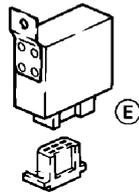
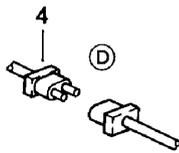
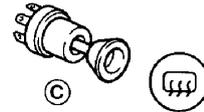
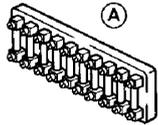
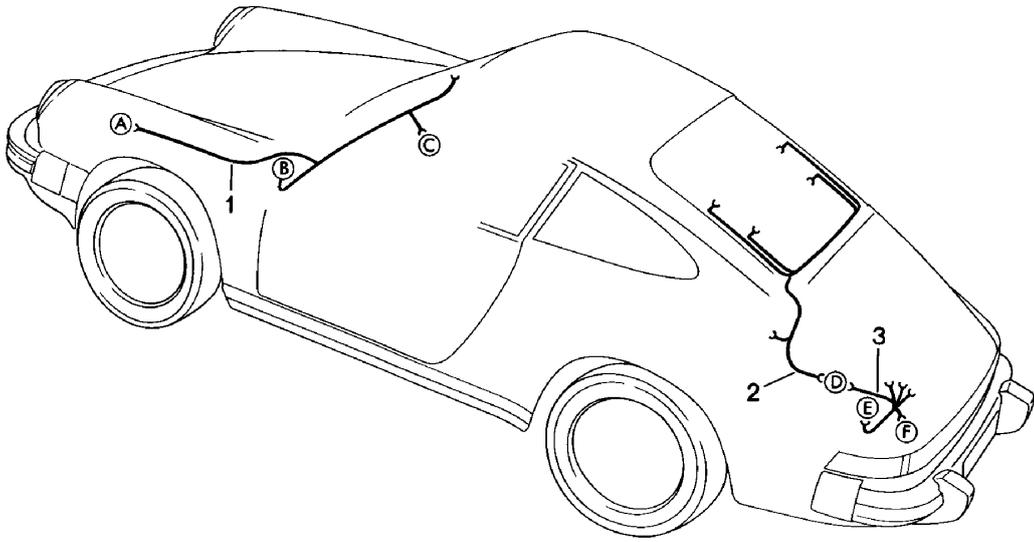

Model: 911 78

Model life 1978>>1983

Pos	Part Number	Description	Remark	Qty	Model
1	911 612 057 00	Wiring harnesses Windscreen heating Rear window heating	/LL	1	
(1)	911 612 057 01	Wiring harness Windscreen heating	/RL	1	
2	911 612 032 01	Wiring harness Rear window heating Two-stage heatable		1	
(2)	911 612 036 00	Wiring harness Rear window heating Single-stage heating		1	
-	911 612 037 01	Wiring harness Rear window		2	COUPE
-	911 612 075 00	Additional cable Rear window		2	TARGA
3	911 612 035 00	Wiring harness Rear window Relay		1	
(3)	911 612 054 00	Two-stage Wiring harness with Mounting plate for Standard type relay		1	
4	911 612 118 00	Connector housing 2-pole for 911.612.032.01		1	
5	901 612 333 00	Plug socket Standard type relay		1	
-	901 612 066 02	Wiring harness Switch		1	

Model: 911 78

Model life 1978>>1983

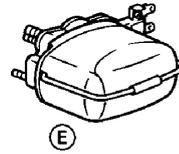
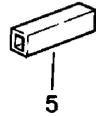
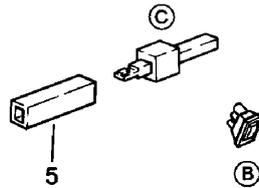
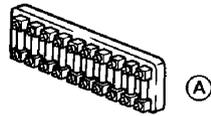
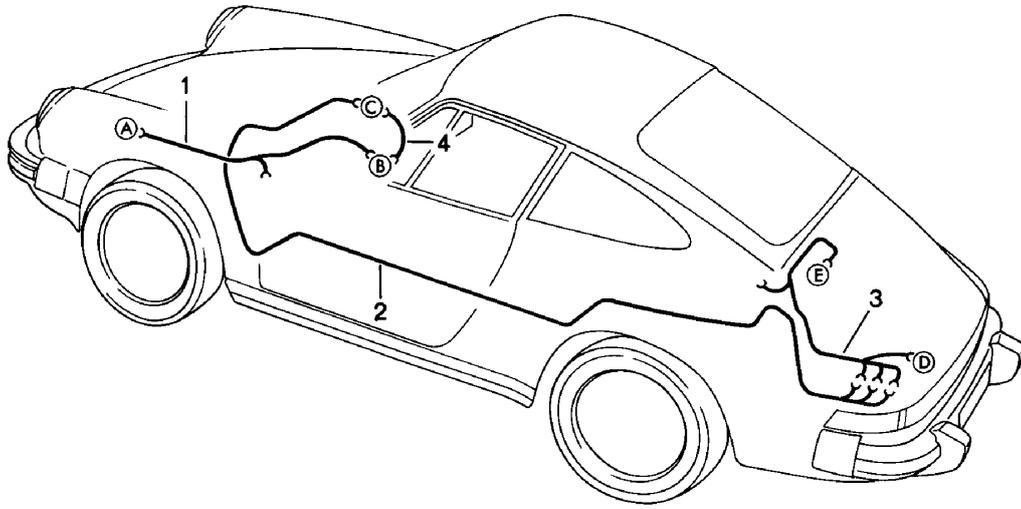

Model: 911 78 Model life 1978>>1983

Pos	Part Number	Description	Remark	Qty	Model
1	911 612 019 00	Wiring harnesses Rear window wiper Wiring harness Switch Fuse box	/LL	1	
1	911 612 099 00	Wiring harness Switch Fuse box	/RL	1	
2	911 612 025 01	Wiring harness Tunnel	/LL	1	
2	911 612 063 01	Wiring harness Tunnel	/RL	1	
3	911 612 031 02	Wiring harness Fuse box Electric motor		1	SC
(3)	911 612 031 01	Wiring harness Fuse box Electric motor		1	TURBO
4	911 612 223 00	Single line Switch Diode		1	
5	111 971 977	Flat connector socket		1	

Model: 911 78

Model life 1978>>1983

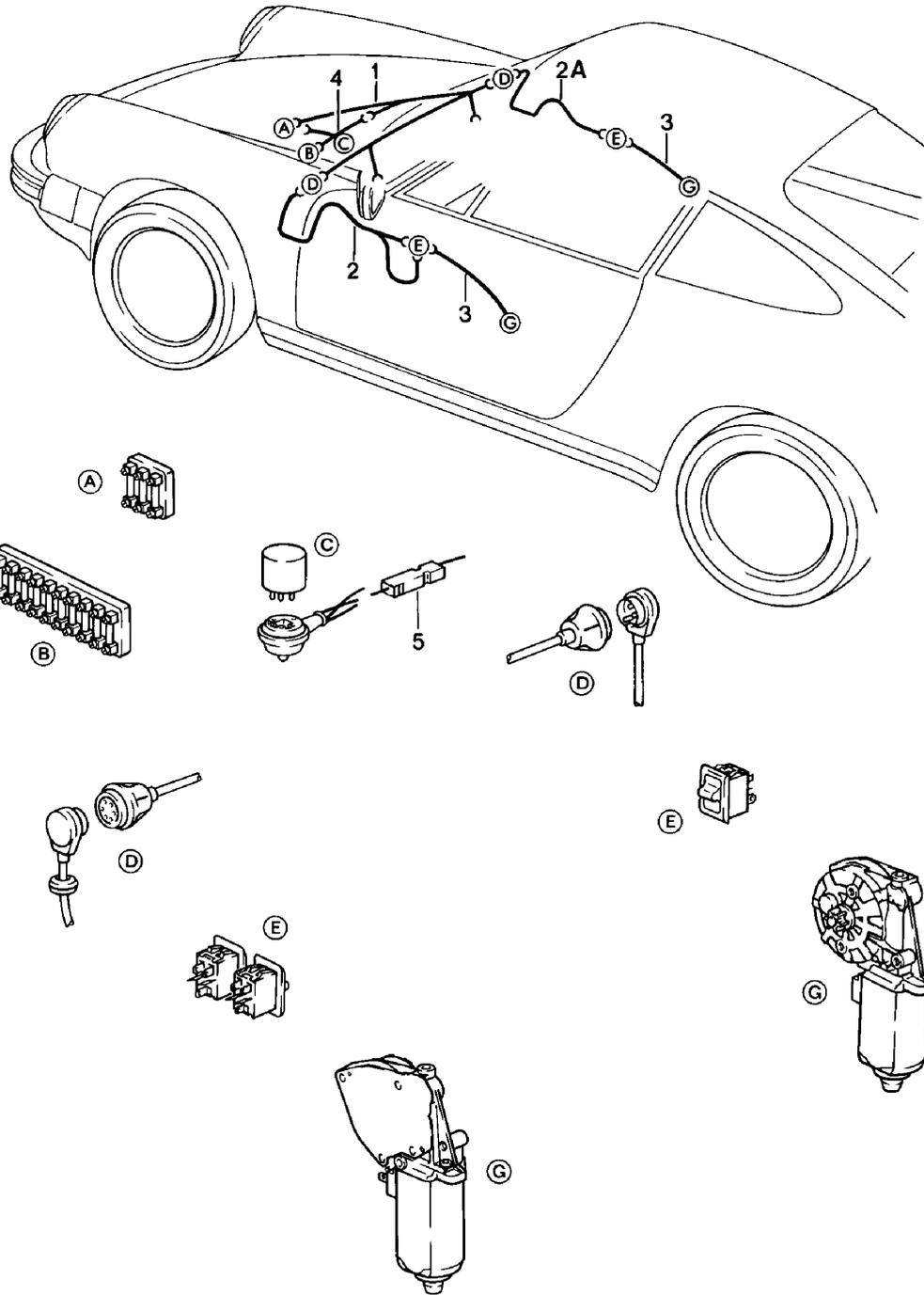

Model: 911 78

Model life 1978>>1983

Pos	Part Number	Description	Remark	Qty	Model
		Wiring harnesses Power window			
1	911 612 167 00	Wiring harness		1	
2	911 612 104 01	Wiring harness Switch	/L	1	
2A	911 612 104 02	Wiring harness Switch	/R	1	
3	911 612 048 00	Wiring harness Switch		2	
4	911 612 147 00	Electric motor Wiring harness		1	
5	111 971 977	Relay Flat connector socket		1	

Model: 911 78

Model life 1978>>1983

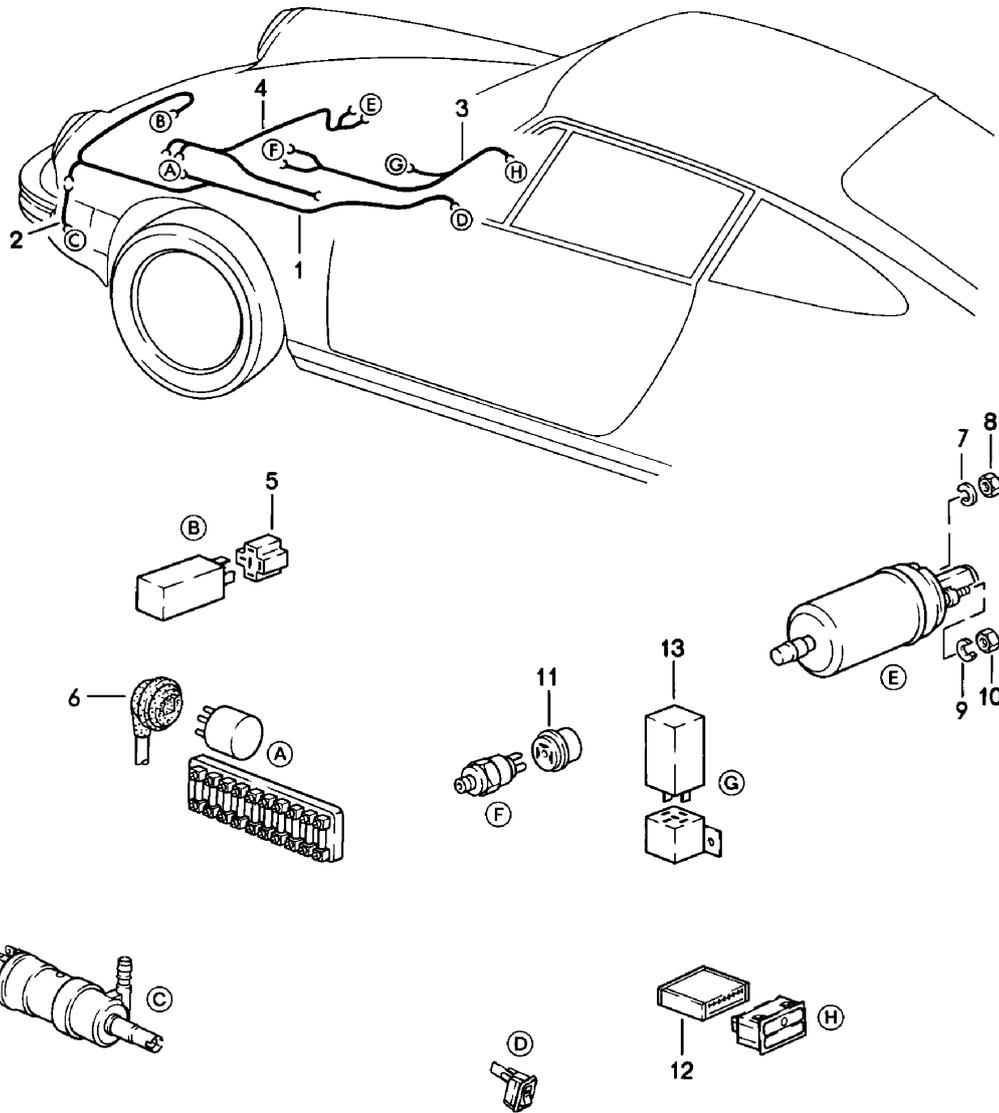

Model: 911 78 Model life 1978>>1983

Pos	Part Number	Description	Remark	Qty	Model
		Wiring harnesses Headlight washer system Warning light Fuel pump			
1	911 612 076 00	Wiring harness	-79	1	
(1)	911 612 076 01	Headlight washer system Wiring harness	80-	1	
2	911 612 179 01	Headlight washer system Wiring harness Pump		1	
3	911 612 041 09	Headlight washer system Wiring harness Warning light	/RL	1	
3	911 612 041 10	Brake Wiring harness Warning light Brake	/LL	1	
-	N 106 568 02	Oval-head sheetmetal screw B 4,8 X 9,5		2	
-	911 612 170 01	Wiring harness Warning light		1	
-	911 612 015 00	Brake fluid Wiring harness Warning light Bridge	(J)	1	
4	911 612 072 14	Wiring harness Fuel pump		1	SC
(4)	930 612 072 02	Wiring harness Fuel pump		1	TURBO
(4)	930 612 072 03	Wiring harness Fuel pump Rear		1	TURBO
5	803 971 835 A	Terminal sleeve housing		1	
6	901 612 333 00	Plug socket Standard type relay		1	
7	900 027 011 01	Lock ring B 4		1	
8	N 011 004 6	Hexagon nut M 4		1	
8	N 011 004 G	Nut M 4		1	
9	N 012 005 3	Lock ring B 5		1	
10	N 011 005 14	Hexagon nut M 5		1	
10	900 076 091 01	Hexagon nut M 5		1	
11	113 945 525	Terminal sleeve housing Brake light switch		2	
12	113 971 998 B	Connector housing Warning light Brake		1	
-	999 652 192 47	Connector housing for Wiring harnesses POS.2 + POS.1		1	
-	815 971 989	Connector housing for Wiring harnesses POS.1 + POS.2		1	
13	911 618 102 00	Warning time relay Seat belt		1	

Model: 911 78

Model life 1978>>1983

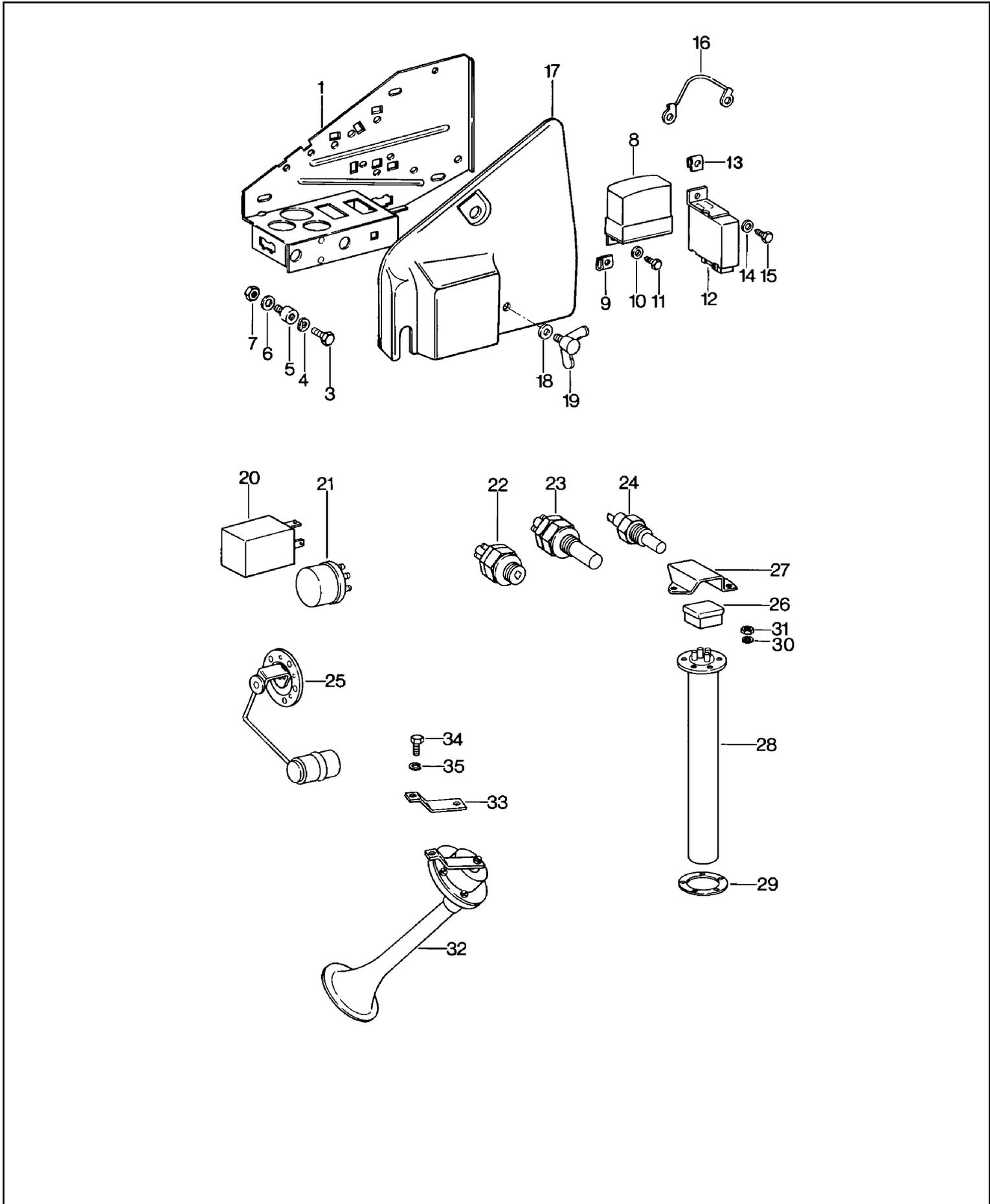

Model: 911 78 Model life 1978>>1983

Pos	Part Number	Description	Remark	Qty	Model
		Mounting plate			
		Relay			
		Sender			
		Fanfare			
1	911 610 103 03	Mounting plate		1	
-	999 507 321 02	Captive nut		4	SC
3	N 010 208 5	Hexagon-head bolt		3	
		M 6 X 8			
4	N 012 226 5	Spring washer		3	
		B 6			
5	999 703 384 00	Megulastik pivot bearing		3	
5	999 703 384 01	Megulastik pivot bearing		3	
6	900 031 011 02	Washer		3	
		B 6,4			
7	900 910 096 02	Lock nut		3	
		VM 6			
7		Lock nut		3	
		M 6			
8	911 603 206 13	Vibration regulator	-81	1	
		Generator			
		MOTOROLA, MARCHAL, SEV			
-	911 619 001 00	Suppression set	-81	1	
		for			
		Vibration regulator			
9	N 015 429 2	Speed nut		2	
		B 4,2			
9	N 015 429 6	Speed nut		2	
		B 4,2			
9	N 015 429 2	Speed nut		2	
		B 4,2			
9	N 015 429 6	Speed nut		2	
		B 4,2			
10	900 151 001 02	Washer		2	
		A 4,3			
11	900 187 013 02	Hexagon-head tapping screw		2	
		BZ 4,2 X 13			
12	911 615 115 00	Relay		1	
		Rear window heating			
		Two-stage			
13	N 015 429 2	Speed nut		1	
		B 4,2			
13	N 015 429 6	Speed nut		1	
		B 4,2			
14	900 151 001 02	Washer		1	
		A 4,3			
15	900 187 013 02	Hexagon-head tapping screw		1	
		BZ 4,2 X 13			
16	911 612 008 00	Ground strap		1	
		Mounting plate			
(17)	930 610 105 03	Cover		1	
		Mounting plate			
18	900 151 003 02	Washer		2	
		A 6,4			
18	900 151 006 03	Washer		2	
		A 6,4			
19	900 029 102 02	Wing screw		2	
		M 6 X 12			
20	914 618 303 11	Flasher relay		1	
(20)	911 618 103 00	Flasher relay		1	
		Only together with			
		Trailer coupling			
21	911 615 109 01	Standard type relay		X	
		Black			

Model: 911 78

Model life 1978>>1983

Pos	Part Number	Description	Remark	Qty	Model
21	911 615 108 01	Standard type relay Red		1	
-	930 617 117 01	Relay Slow-action relay Ignition cut-off		1	TURBO
-	930 617 117 02	Relay Slow-action relay Ignition cut-off		1	TURBO
-	930 617 117 01	Relay Slow-action relay Ignition cut-off		1	TURBO
-	930 617 117 02	Relay Slow-action relay Ignition cut-off		1	TURBO
22	914 613 541 02	Back-up light switch		1	
(22)	905 613 051 02	Back-up light switch		1	SPM
23	905 613 101 02	Bridging switch		1	SPM
24	905 613 102 04	Temperature switch Oil temperature		1	SPM
-	999 652 315 02	Flat plug Ground cable		1	
26	901 612 891 01	Connector housing Sender		1	
27	901 201 275 30	Cap for Sender Yellow Anodised		1	
(27)	901 201 275 31	Cap for Sender Black		1	
28	901 741 801 00	Sender Fuel-level indicator Fuel tank 62 - 85 L See group 2/01/00		1	
29	477 919 133	Sealing ring		1	
29		Sealing ring		1	
30	N 012 222 4	Spring washer A 5		5	
31	N 011 005 14	Hexagon nut M 5		5	
31	900 076 091 01	Hexagon nut M 5		5	
32	911 635 101 20	Fanfare Short High-pitched		1	
32	911 635 101 21	Fanfare Short High-pitched		1	
(32)	911 635 102 20	Fanfare Long Low-pitched		1	
(32)	911 635 102 21	Fanfare Long Low-pitched		1	
33	911 635 091 00	Support High-pitched		1	
(33)	911 635 097 01	Support Low-pitched		1	
34	900 075 087 02	Hexagon-head bolt		2	

Model: 911 78

Model life 1978>>1983

Pos	Part Number	Description	Remark	Qty	Model
34	900 075 087 03	M 8 X 16 Hexagon-head bolt		2	
35	900 027 015 02	M 8 X 16 Lock ring		2	
35	900 027 015 03	B 8 Lock ring		2	
-	911 612 093 03	B 8 Fuse box 3-pole for		1	
-	900 014 074 02	Mounting plate Pan-head screw		2	
-	N 012 224 3	AM 4 X 12 Spring washer		2	
-	N 011 004 6	B 4 Hexagon nut		2	
-	N 011 004 G	M 4 Nut		2	
-	999 702 119 50	M 4 Rubber sleeve		2	

Model: 911 78

Model life 1978>>1983

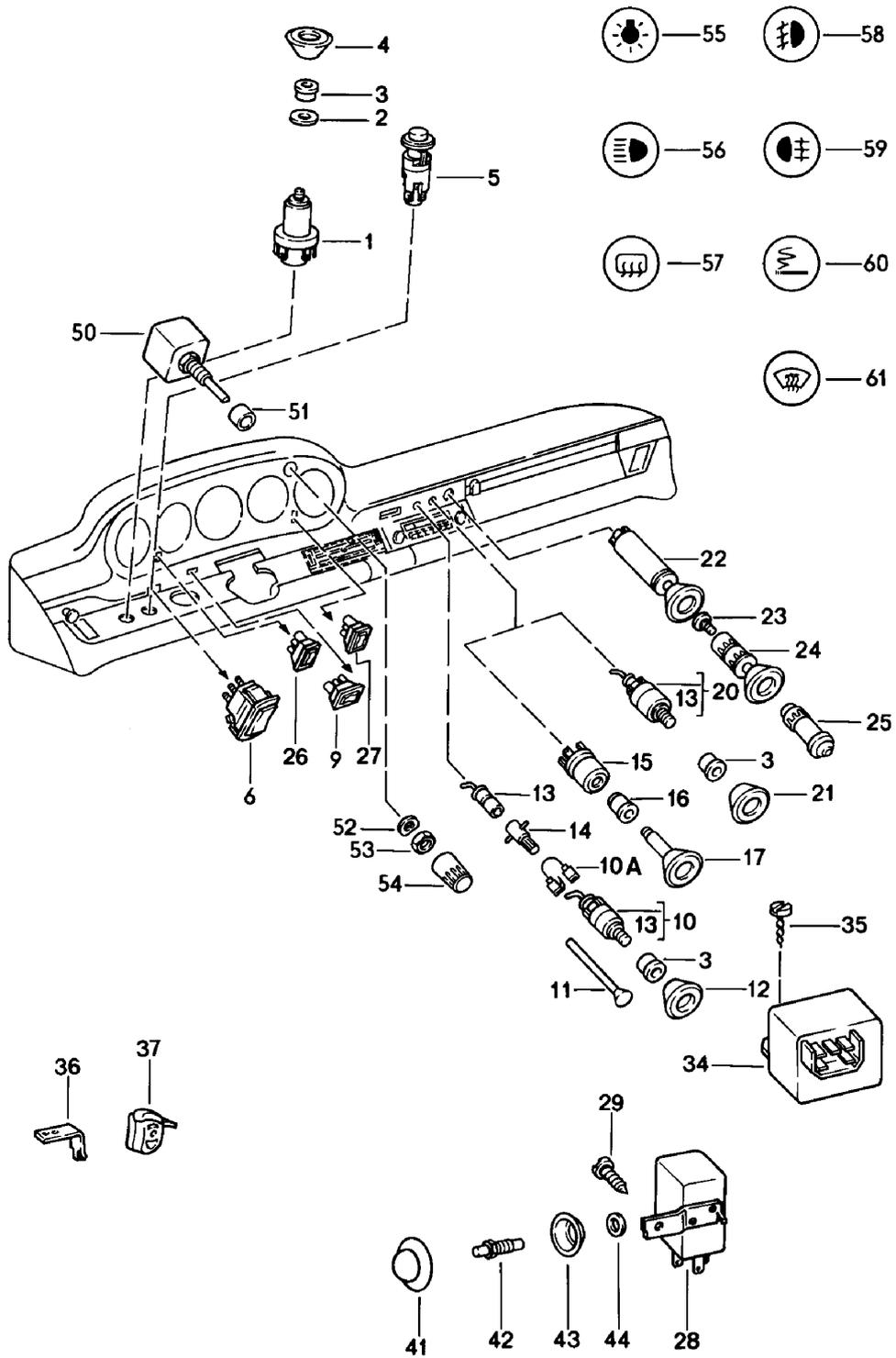

Model: 911 78 Model life 1978>>1983

Pos	Part Number	Description	Remark	Qty	Model
		Switch			
		Relay			
1	911 613 029 03	Push-pull light switch		1	
2	900 151 026 02	Washer		1	
2	900 151 050 01	Washer		1	
3	911 613 213 02	Rosette	-80	2	
(3)	911 613 213 03	Rosette	81-	2	
4	911 613 215 00	Knob		1	
5	911 613 124 32	Hazard warning light sw.		1	
-	900 631 102 90	Light		1	
		2 W			
6	911 613 622 00	Tip switch		1	
		for sliding roof			
6	911 613 622 01	Tip switch		1	
		for sliding roof			
-	911 613 621 03	Switch		3	
		for window opener			
-	911 613 635 20	Assembly frame		3	
		for window opener			
9	911 613 113 00	Changeover switch		1	
		Door mirror			
10	902 613 623 90	Switch	-80	1	
		Rear window heating			
		Single-stage heating			
(10)	911 613 149 00	Switch	81-	1	
		Rear window heating			
		Single-stage heating			
(10)	911 613 145 00	Switch	-80	1	
		Rear window heating			
		Two-stage heatable			
(10)	911 613 147 00	Switch	81-	1	
		Rear window heating			
		Two-stage heatable			
11	911 613 228 00	Luminous stick	-80	1	
-	999 703 067 50	Stopper		1	
12	911 613 215 03	Knob	-80	1	
(12)	911 613 028 03	Knob	81-	1	
13	999 632 007 00	Bulb socket		1	
14	900 631 102 90	Light	-80	1	
		12 V 2 W			
(14)	900 631 132 90	Bulb	81-	1	
15	914 613 451 10	Switch	-80	1	
		Fog headlamp			
		Rear fog light			
(15)	911 613 147 00	Switch	81-	1	
		Fog headlamp			
		Rear fog light			
16	911 613 213 03	Rosette		1	
17	911 613 028 03	Knob		1	
20	902 613 623 90	Switch	-80	1	
		Fog headlamp			
		Or			
		Rear fog light			
(20)	911 613 149 00	Switch	81-	1	
		Fog headlamp			
		Rear fog light			
-	911 612 251 00	Resistor	-80	1	
		for			
		Switch			
		Fog headlamp			
		Rear fog light			
21	911 613 215 02	Knob	-80	1	
(21)	911 613 028 03	Knob	81-	1	

Model: 911 78 Model life 1978>>1983

Pos	Part Number	Description	Remark	Qty	Model
22	911 652 102 02	Cigarette lighter		1	
22	911 652 102 07	Cigarette lighter		1	
23	644 652 112 00	Glower		1	
24	911 652 122 02	Cigarette lighter Connector		1	
25	901 613 801 00	Connector		1	
26	911 613 321 01	Tip switch Rear window wiper		1	
27	911 613 319 01	Tip switch Headlight washer system		1	
28	928 618 111 00	Relay Headlight washer system		1	
29	N 013 968 7	Tapping screw B 4,8 X 13		1	
29	900 143 097 01	Tapping screw B 4,8 X 13		1	
34	911 618 149 01	Pulse sender Wipe interval		1	
35	N 013 970 5	Oval-head sheetmetal screw B 4,8 X 9,5		1	
35	N 106 568 02	Oval-head sheetmetal screw B 4,8 X 9,5		1	
36	901 613 523 20	Contact bow Hand brake switch		1	
37	901 613 521 20	Contact switch		1	
41	901 615 616 20	Rubber cap		2	
42	964 613 601 00	Door contact switch Luggage compartment lamp		3	
(42)	928 613 147 00	Door contact switch Interior light	80-	2	
(42)	901 615 601 02	Contact switch Glove compartment light		1	
(42)	901 615 601 03	Contact switch Glove compartment light		1	
43	901 615 615 20	Concave washer		2	
44	900 031 001 60	Washer A 8,4		2	
50	911 618 147 01	Potentiometer Wipe interval		1	
50	911 618 147 02	Potentiometer Wipe interval		1	
51	911 618 207 00	Spacer sleeve		1	
52	900 028 019 01	Spring washer B 7		1	
53	911 618 209 00	Hexagon nut M 7 X 0,75		1	
54	911 618 011 00	Knob Cap with symbol		1	
55	911 613 239 01	Cap with symbol Light switch		1	
55	911 613 239 02	Cap with symbol Light switch		1	
57	911 613 232 02	Cap with symbol		1	
	911 613 232 02 01C	Satin black Rear window heating			
57	911 613 232 03	Cap with symbol		1	
	911 613 232 03 01C	Satin black Rear window heating			
57	911 613 232 03	Cap with symbol		1	
	911 613 232 03 01C	Satin black Rear window heating			
58	911 613 233 01	Cap with symbol		1	

Model: 911 78

Model life 1978>>1983

Pos	Part Number	Description	Remark	Qty	Model
59	911 613 234 01	Fog headlamp Cap with symbol		1	
60	911 613 235 01	Rear fog light Cap with symbol		1	
60	911 613 235 02	Cigarette lighter Cap with symbol		1	
61	911 613 240 01	Cigarette lighter Cap with symbol Windscreen heating		1	

Model: 911 78

Model life 1978>>1983

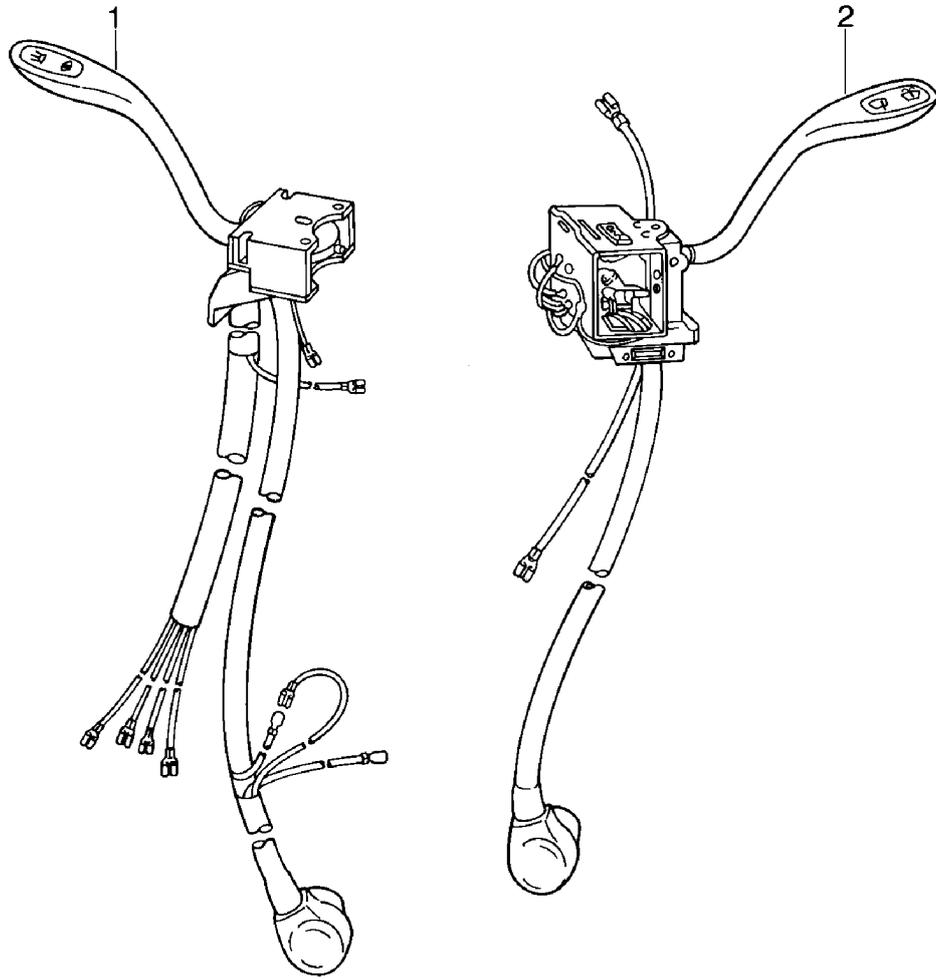

Model: 911 78

Model life 1978>>1983

Pos	Part Number	Description	Remark	Qty	Model
1	911 613 305 01	Steering column switch Steering column switch Direction indicator light Low/high beam		1	
(1)	911 613 307 01	Combined switch	(B) (I) (L) -80	1	
2	911 613 306 02	Direction indicator light Low/high beam Steering column switch Windscreen wiper system		1	

Model: 911 78

Model life 1978>>1983

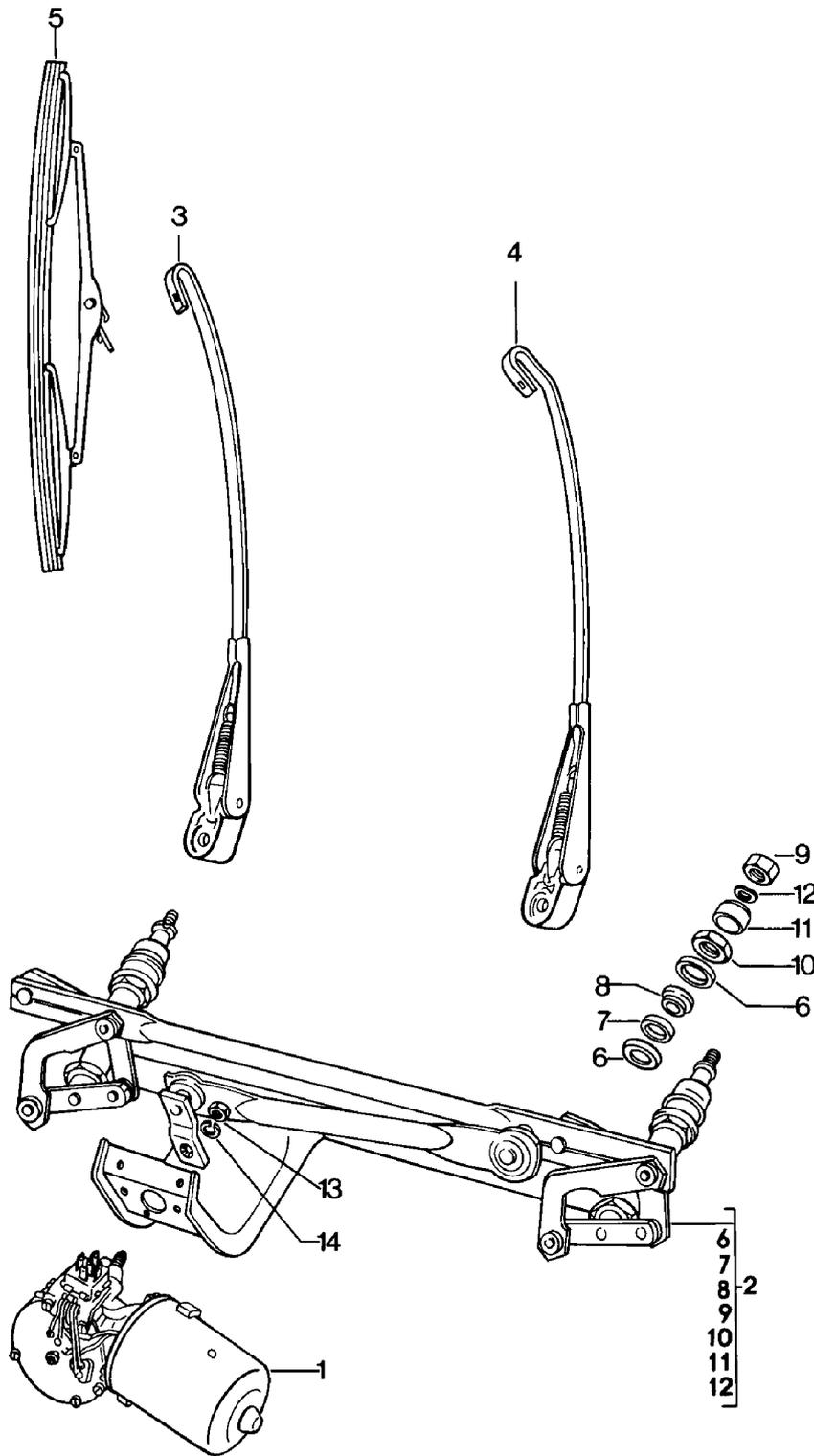

Model: 911 78

Model life 1978>>1983

Pos	Part Number	Description	Remark	Qty	Model
		Windscreen wiper system			
1	911 628 115 01	Wiper motor	/LL	1	
(1)	911 628 114 00	Wiper motor	/RL	1	
2	911 628 961 00	Crank drive	/LL	1	
(2)	911 628 961 01	Crank drive	/RL	1	
3	911 628 313 00	Wiper arm	/LL /L /RL /R	1	
4	911 628 314 00	Wiper arm	/LL /R	1	
(4)	911 628 312 00	Wiper arm	/RL /L	1	
5	964 628 901 00	Wiper blade		2	
5	964 628 901 02	Wiper blade		2	
6	911 628 963 00	Flange washer Black		4	
7	901 628 923 01	Rubber bush		2	
8	901 628 924 00	Rubber bush		2	
9	N 011 118 11	Hexagon nut BM 8		2	
9	900 034 001 05	Hexagon nut BM 8		2	
10	901 628 925 00	Hexagon nut		2	
11	901 628 926 00	Cap		2	
12	901 628 927 00	Spring washer		2	
12	481 955 349	Spring washer		2	
12	803 955 437	Spring washer		2	
13	900 076 010 02	Nut M 6		1	
13	900 076 010 0B	Nut M 6		1	
14	N 042 121 1	Shake-proof washer 6,4		1	

Model: 911 78

Model life 1978>>1983

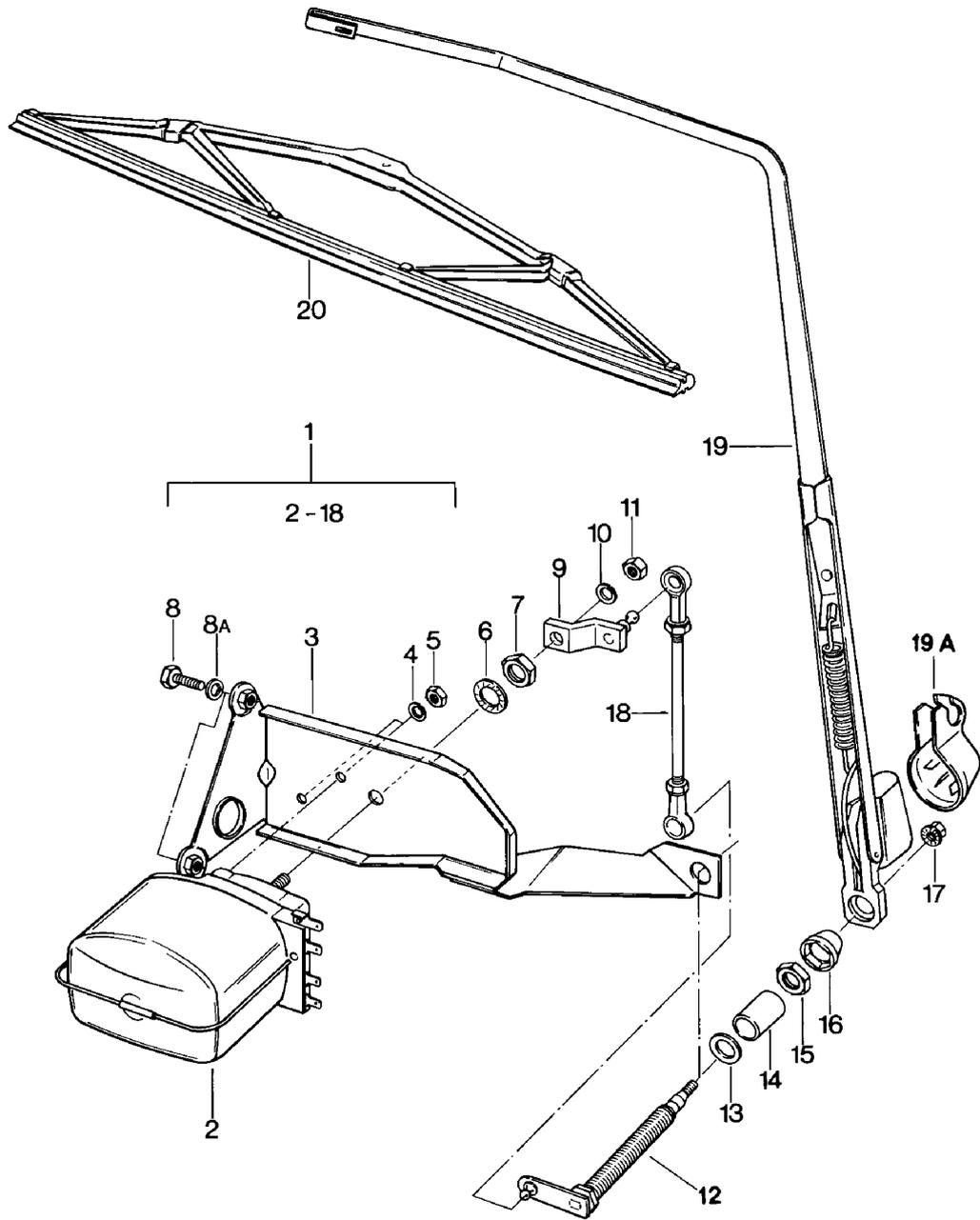

Model: 911 78 Model life 1978>>1983

Pos	Part Number	Description	Remark	Qty	Model
		Rear window wiper for subsequent installation 911SC /M 559 Use also: 911.573.057.04		1	
1	911 628 019 03	Rear window wiper without Wiper arm Wiper blade		1	SC
(1)	911 628 019 04	Rear window wiper without Wiper arm Wiper blade	-80	1	SC M473
(1)	911 628 019 05	Rear window wiper without Wiper arm Wiper blade	81-	1	SC M473 TURBO
2	911 628 063 00	Wiper motor		1	
3	911 628 037 01	Assembly frame		1	
4	N 012 006 4	Lock ring		2	
5	999 076 023 02	Hexagon nut M 5		2	
6	911 628 338 00	Washer 14,2		1	
7	999 078 014 02	Hexagon nut M 14 X 1		1	
8	999 072 005 09	Hexagon nut M 6 X 12		2	
8	999 072 005 01	Hexagon nut M 6 X 12		2	
8A	N 012 006 4	Lock ring B 6		1	
9	901 628 318 00	Lever		1	
10	N 012 006 4	Lock ring A 6		1	
11	999 076 024 02	Hexagon nut M 6		1	
12	911 628 256 02	Wiper bearing		1	SC
(12)	911 628 256 01	Wiper bearing		1	SC M473 TURBO
13	999 040 002 00	Round seal B 10		1	
14	911 628 251 03	Bush		1	SC
(14)	911 628 251 01	Bush		1	SC M425/473
(14)	911 628 251 04	Bush		1	SC M473
(14)	911 628 251 02	Bush		1	TURBO
15	999 183 004 02	Hexagon nut M 12 X 1		1	
16	911 628 193 00	Cap		1	
17	999 084 045 02	Lock nut M 6		1	
18	911 628 145 00	Joint rod		1	
18	911 628 145 01	Joint rod		1	
19	911 628 611 01	Wiper arm		1	
19A	911 628 623 00	Cap	82-	1	
20	911 628 613 01	Wiper blade		1	
-	911 613 321 01	Tip switch		1	
-	911 612 031 02	Wiring harness		1	SC

Model: 911 78

Model life 1978>>1983

Pos	Part Number	Description	Remark	Qty	Model
-	911 612 031 01	Wiper motor Wiring harness		1	TURBO
-	911 612 025 01	Wiper motor Wiring harness	/LL	1	
-	911 612 063 01	Wiper switch Wiring harness	/RL	1	
-	911 612 223 00	Wiper switch Single line		1	
-	911 612 019 00	Wiper switch Wiring harness	/LL	1	
-	911 612 099 00	Wiper switch Wiring harness	/RL	1	
-	911 617 106 01	Wiper switch Diode		1	
-	911 617 106 02	Diode		1	

Model: 911 78

Model life 1978>>1983

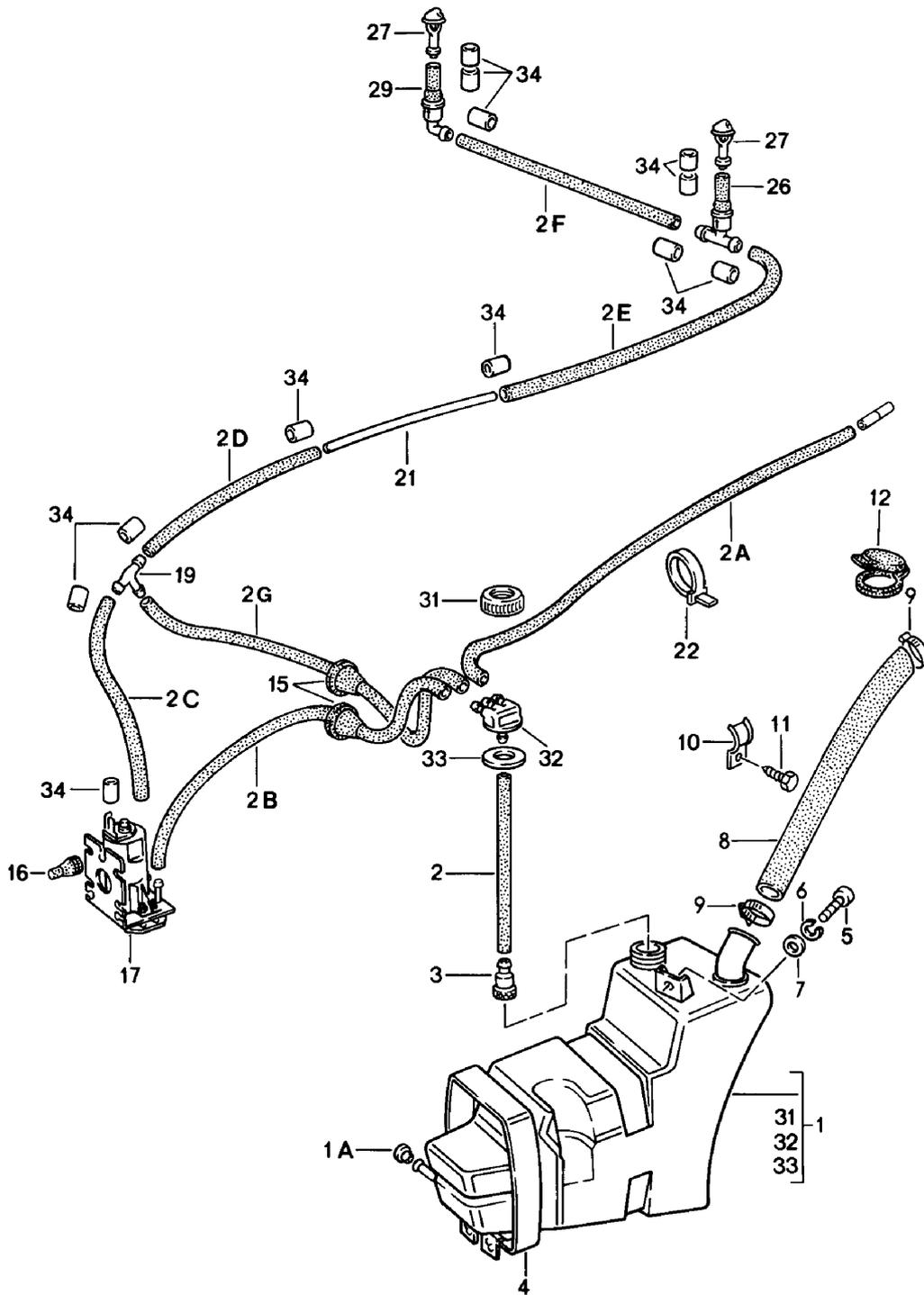

Model: 911 78

Model life 1978>>1983

Pos	Part Number	Description	Remark	Qty	Model
		Windscreen washer system			
1	911 628 075 08	Water reservoir		1	
1		Water reservoir	-79	1	M288
1	911 628 075 07	Water reservoir	80-	1	M288
1A	999 703 013 50	Stopper		1	
-	N 020 301 1	Hose		X	
		PVC 4 X 1			
-	PCG 020 301 10	Hose		X	
		PVC 4 X 1			
		3000 MM			
2		300 MM		1	
2A		800 MM		1	
2B		650 MM		1	
2C		150 MM		1	
2D		360 MM		1	
2E		360 MM		1	
2F		900 MM		1	
2G		500 MM		1	
3	911 628 749 00	Valve		1	
		Water reservoir			
4	911 628 081 00	Restraining strap		1	
4	911 628 081 02	Restraining strap		1	
5	N 010 217 9	Hexagon-head bolt		1	
		M 6 X 20			
6	N 012 007 2	Lock ring		1	
		A 6			
6	900 027 004 03	Lock ring		1	
		A 6			
7	900 151 003 02	Washer		1	
		A 6,4			
7	900 151 006 03	Washer		1	
		A 6,4			
8	911 628 236 00	Filling hose		1	
		25 X 32 X 710			
8	911 628 236 01	Filling hose		1	
		25 X 32 X 710			
9	999 512 356 02	Hose clamp		2	
10	911 573 145 00	Clamp		1	
10	911 573 145 01	Clamp		1	
11	900 187 025 02	Hexagon-head tapping screw		1	
		B 5,5 X 13			
12	964 201 507 00	Lid		1	
		Filler neck			
15	911 612 132 00	Grommet		1	
16	914 628 741 00	Stopper		3	
17	928 628 074 01	Pump		1	
		Electric			
19	901 628 749 20	T-piece		1	
21	911 628 237 00	Pipe		1	
		4 X 5 X 1100 MM			
21	901 628 739 22	Pipe		1	
		4 X 5 X 1100 MM			
22	999 513 023 40	Tie-wrap		2	
26	914 628 433 00	Valve		1	
27	914 628 203 11	Nozzle		2	
29	911 628 999 00	Valve	-80	1	
29	477 955 481	Valve	81-	1	
31	911 628 735 00	Threaded cover		1	
31	911 628 735 01	Threaded cover		1	
32	911 628 737 00	Connecting piece		1	
33	911 628 743 00	Closing gasket		1	
34	111 971 521 A	Hose		8	

Model: 911 78

Model life 1978>>1983

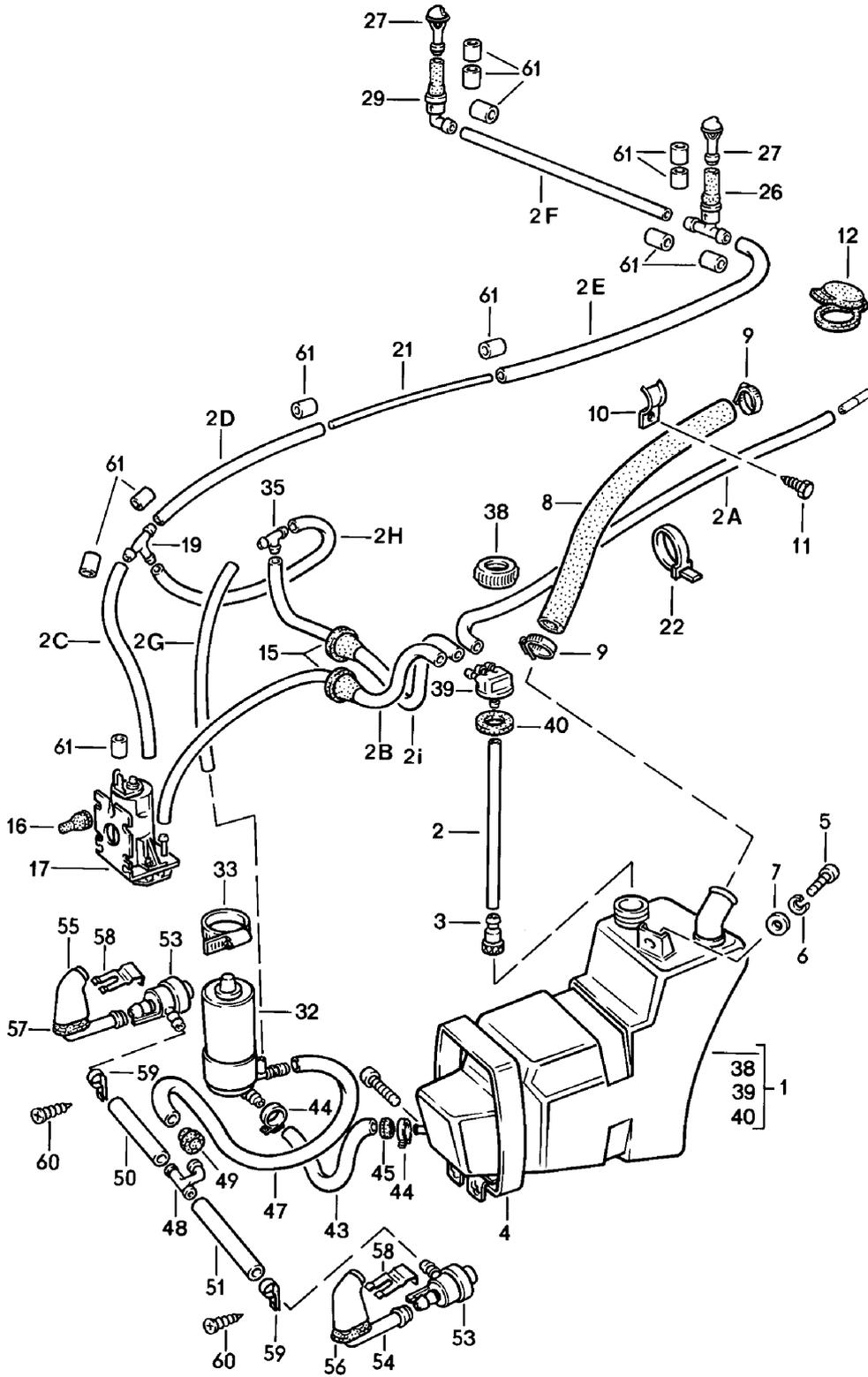

Model: 911 78 Model life 1978>>1983

Pos	Part Number	Description	Remark	Qty	Model
		Windscreen washer system	-79		
		Headlight washer system			
1	911 628 075 08	Water reservoir		1	
-	N 020 301 1	Hose		1	
		PVC 4 X 1			
-	PCG 020 301 10	Hose		X	
		PVC 4 X 1			
		3000 MM			
2		300 MM		1	
2A		800 MM		1	
2B		650 MM		1	
2C		150 MM		1	
2D		360 MM		1	
2E		360 MM		1	
2F		900 MM		1	
2G		510 MM		1	
(2G)		320 MM		1	
		for cars with			
		Air conditioner			
2H		100 MM		1	
2I		530 MM		1	
3	911 628 749 00	Valve		1	
		Water reservoir			
4	911 628 081 00	Restraining strap		1	
4	911 628 081 02	Restraining strap		1	
5	N 010 217 9	Hexagon-head bolt		1	
		M 6 X 20			
6	N 012 007 2	Lock ring		1	
		A 6			
6	900 027 004 03	Lock ring		1	
		A 6			
7	900 151 003 02	Washer		1	
		A 6,4			
7	900 151 006 03	Washer		1	
		A 6,4			
8	911 628 236 00	Filling hose		1	
		25 X 32 X 710			
8	911 628 236 01	Filling hose		1	
		25 X 32 X 710			
9	999 512 356 02	Hose clamp		2	
10	911 573 145 00	Clamp		1	
10	911 573 145 01	Clamp		1	
11	900 187 025 02	Hexagon-head tapping screw		1	
		B 5,5 X 13			
12	964 201 507 00	Lid		1	
		Filler neck			
15	911 612 132 00	Grommet		2	
16	914 628 741 00	Stopper		3	
17	928 628 074 01	Pump		1	
		Electric			
19	901 628 749 20	T-piece		1	
21	911 628 237 00	Pipe		1	
		4 X 5 X 1100			
21	901 628 739 22	Pipe		1	
		4 X 5 X 1100			
22	999 513 023 40	Tie-wrap		2	
26	914 628 433 00	Valve		1	
27	914 628 203 11	Nozzle		2	
(27)	944 628 911 00	Nozzle		2	
		Heatable			
29	911 628 999 00	Valve		1	
(32)	477 955 679 A	Pump		1	
33	999 512 164 02	Hose clamp		1	

Model: 911 78

Model life 1978>>1983

Pos	Part Number	Description	Remark	Qty	Model
35	911 628 748 00	Valve		1	
38	911 628 735 00	Threaded cover		1	
38	911 628 735 01	Threaded cover		1	
39	911 628 737 00	Connecting piece		1	
40	911 628 743 00	Closing gasket		1	
-	999 181 182 40	Hose		*	
		PVC 10 X 14			
43		330 MM		1	
(43)		140 MM		1	
		for cars with			
		Air conditioner			
44	999 512 134 02	Hose clamp		2	
45	021 119 569 A	Rubber sleeve		1	
47	900 918 031 40	Pressure hose		*	
		10 X 12,5			
47	900 918 031 4B	Pressure hose		1	
		10 X 12,5			
(47)	900 918 031 40	Pressure hose		*	
(47)	900 918 031 4B	Pressure hose		1	
(47)	900 918 031 40	Pressure hose		*	
		PA 11			
		for cars with			
		Air conditioner			
(47)	900 918 031 4B	Pressure hose		1	
		PA 11			
		for cars with			
		Air conditioner			
48	914 628 413 10	Distributing piece		1	
-	999 512 554 00	Hose clamp		2	
49	411 941 189	Grommet		1	
-	900 918 031 40	Pressure hose		*	
		10 X 12,5			
50		780 MM		1	
51		480 MM		1	
50	900 918 031 4B	Pressure hose		X	
		10 X 12			
		780MM			
51		Pressure hose		X	
		10 X 12			
		480MM			
53	113 955 187	Pressure control valve		2	
54	911 628 085 00	Nozzle		1	
54	911 628 085 02	Nozzle		1	
55	911 628 086 00	Nozzle		1	
55	911 628 086 01	Nozzle		1	
56	911 628 807 00	Desk pad		1	
		Jet carrier			
57	911 628 808 00	Desk pad		1	
		Jet carrier			
58	113 955 199	Retainer spring		2	
59	999 511 052 02	Clamp		2	
60	N 013 968 7	Tapping screw		2	
		B 4,8 X 13			
60	900 143 097 01	Tapping screw		2	
		B 4,8 X 13			
61	111 971 521 A	Hose		12	

Model: 911 78

Model life 1978>>1983

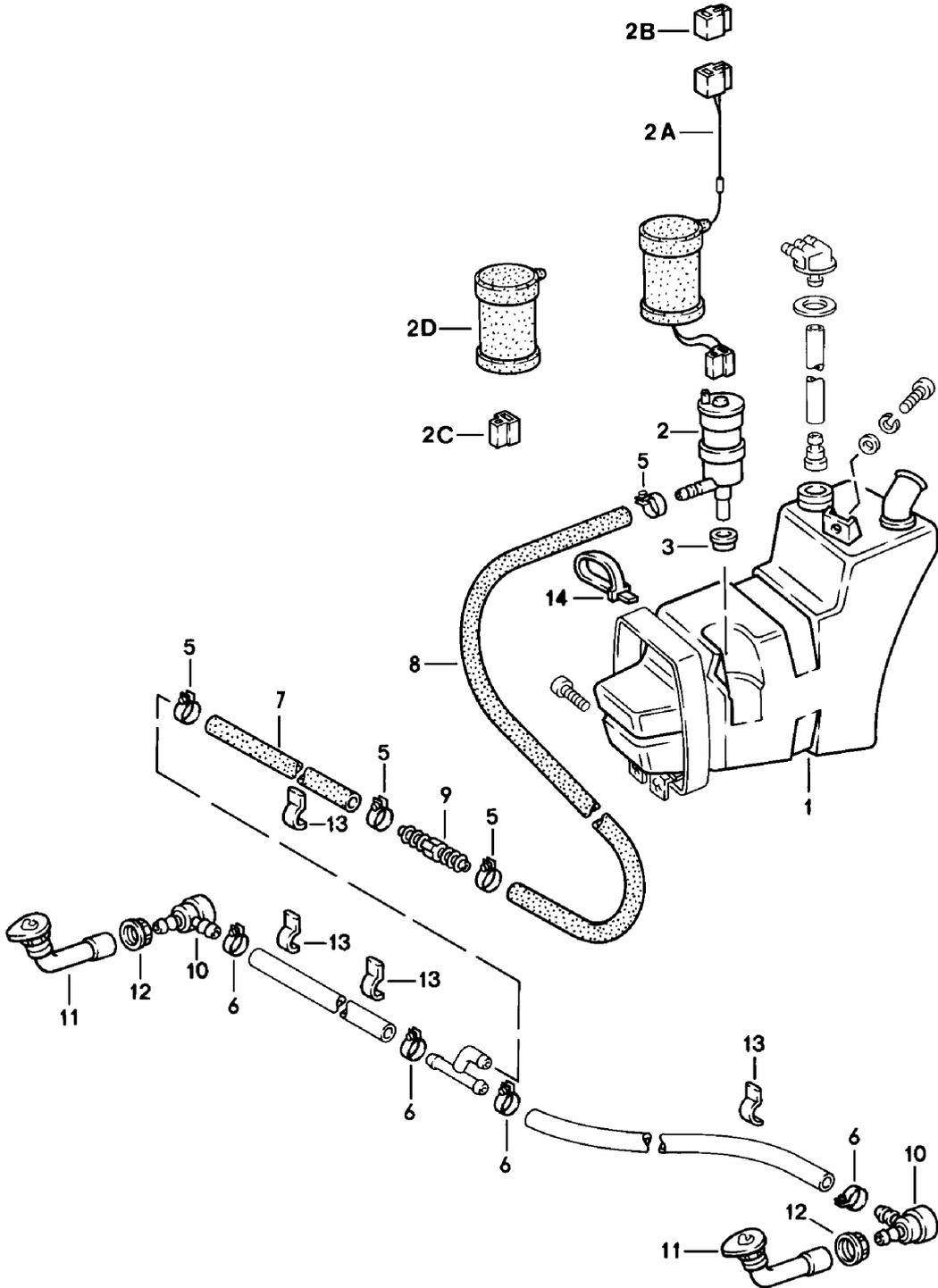

Model: 911 78

Model life 1978>>1983

Pos	Part Number	Description	Remark	Qty	Model
		Windscreen washer system	80-		
		Headlight washer system			
		See group			
		9/04/15			
1	911 628 075 07	Water reservoir		1	
2	191 955 681	Pump		1	
2A	911 612 179 01	Wiring harness		1	
2B	999 652 192 47	Connector housing		1	
2C	999 652 167 40	Terminal sleeve housing		1	
2D	477 971 921	Protection cap		1	
3	928 628 193 00	Gasket		1	
5	N 023 570 2	Hose clamp		4	
6	999 512 160 02	Hose clamp		4	
6	PCG 512 160 02	Hose clamp		4	
-	999 181 806 40	Hose		*	
		PVC 10 X 16			
7		420 MM		1	
8		230 MM		1	
9	999 137 023 40	Hose connection		1	
10	477 955 183	Pressure control valve		2	
11	911 628 085 01	Jet carrier		2	
12	900 281 002 40	Hexagon nut		2	
		APG 11			
13	999 613 017 40	Covering		*	
		Cable holder			
14	999 513 008 40	Tie-wrap		1	

Model: 911 78

Model life 1978>>1983

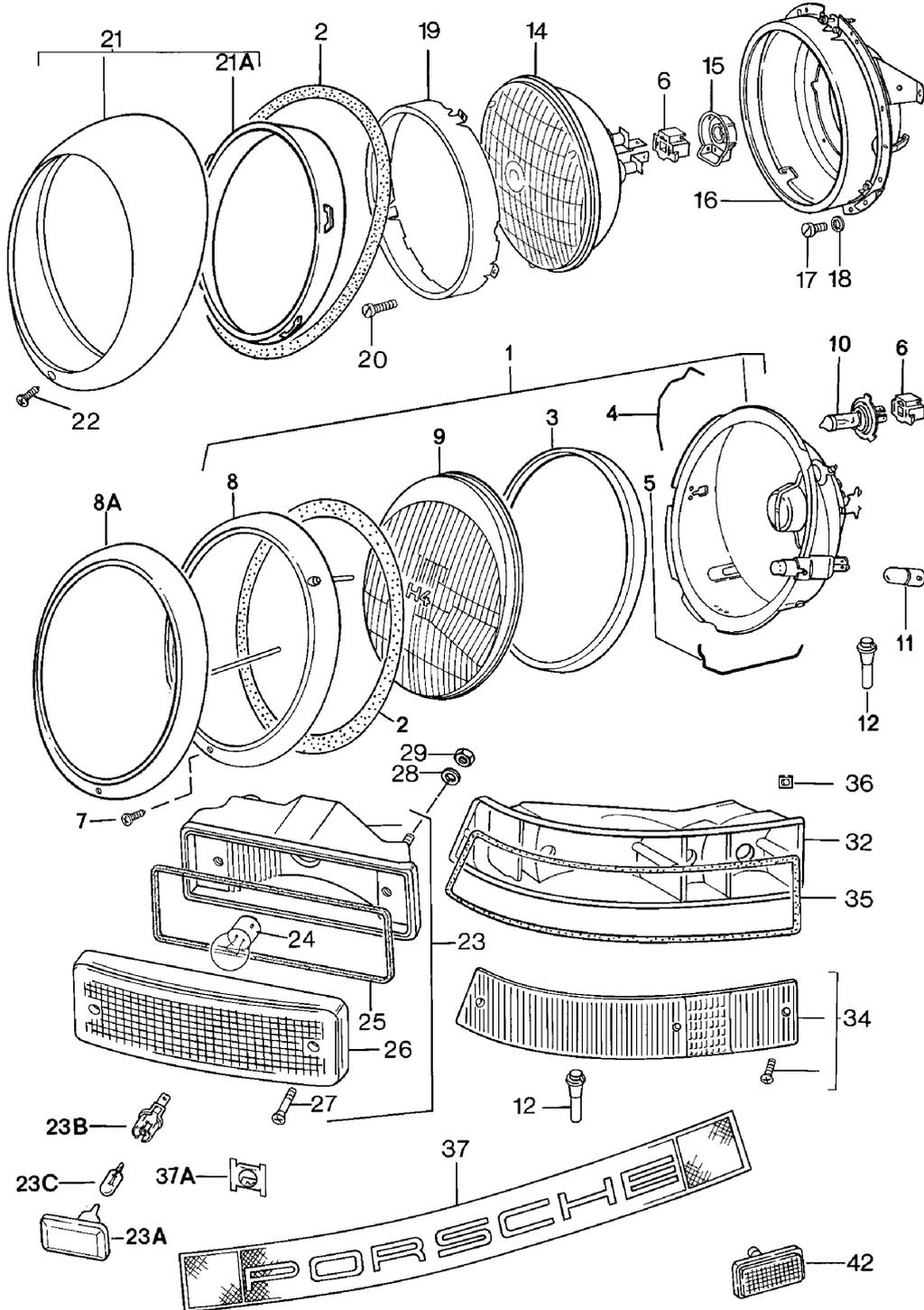

Model: 911 78 Model life 1978>>1983

Pos	Part Number	Description	Remark	Qty	Model
1	911 631 112 00	Headlamp Lights Headlamp	/RL (AUS) (GB)	2	
		Headlamp ring Chrome			(HK) (RSA)
1	911 631 112 02	Headlamp	/RL (AUS) (GB)	2	
		Headlamp ring Resicoated			(HK) (RSA)
1	911 631 113 00	Headlamp	/LL	2	
		Headlamp ring Chrome			
1	911 631 113 02	Headlamp	/LL	2	
		Headlamp ring Resicoated			
2	911 631 115 02	Gasket		2	
3	911 631 967 00	Gasket		2	
4	901 631 116 02	Locking spring Upper		6	
5	644 631 122 00	Locking spring Lower		5	
6	911 631 108 00	Terminal sleeve housing		2	
-	N 017 498 A	Flat plug 7,7 X 1 CuZn		X	
7	900 270 063 07	Countersunk-head screw	-80	2	
7	911 631 132 00	Oval-head screw M 4 X 9	81-	2	
8	911 631 933 00	Headlamp ring Chrome		2	
8	911 631 933 01	Headlamp ring Resicoated		2	
8A	911 631 141 00	Headlamp ring Prime coated		2	
-	911 631 033 00	Ball screw for Headlamp ring Prime coated		2	
-	911 631 132 00	Oval-head screw M 4 X 9 for Headlamp ring Prime coated		2	
-	113 951 539	Washer	-80	2	
-		Washer		2	
-	911 631 139 00	Spacer sleeve		2	
9	911 631 927 01	Lens for 911.631.112.00/112.02		2	
-	PCG 911 631 01	Kit Lens Comprising:	/RL	1	
-	911 631 927 01	Lens		2	
-	911 631 115 02	Gasket		2	
-	911 631 967 00	Gasket		2	
-	113 951 539	Washer		2	
(9)	911 631 927 00	Lens for 911.631.113.00/113.02		2	
-	PCG 911 631 00	Kit Lens Comprising:	/LL	1	
-	911 631 927 00	Lens		2	

Model: 911 78 Model life 1978>>1983

Pos	Part Number	Description	Remark	Qty	Model
-	911 631 115 02	Gasket		2	
-	911 631 967 00	Gasket		2	
-	113 951 539	Washer		2	
10	999 631 202 90	Bulb H 4 12 V - 60/55 W		2	
(10)	999 631 202 91	Halogen bulb H 4 12 V - 60/55 W Yellow	(F)	2	
11	900 631 103 90	Bulb 12 V - 4 W		2	
12	911 631 259 02	Rubber sleeve		4	
20	N 014 122 17	Oval-head screw M 4 X 8		6	
23	911 631 405 00	Direction indicator light		2	
(23)	911 631 417 00	Direction indicator light	(DK) (I) (N) -80 (J)	2	
(23)	911 631 413 00	Side direction indicator	(DK) (I) (N) -80 (J)	2	
23A	4A0 949 101	Direction indicator light Not for (USA)(CDN)	80-	2	
23B	161 949 111	Bulb socket Not for (USA)(CDN)	80-	2	
23C	999 631 032 90	Bulb	80-	2	
24		Bulb See group 9/05/05			
25	911 631 961 00	Rubber seal		2	
26	911 631 914 00	Direction indicator light Lens Yellow		2	
(26)	911 631 957 00	Direction indicator light Lens	(DK) (I) (N) (J)	2	
27	911 631 918 00	Direction indicator light		4	
28	900 025 003 02	Oval-head sheetmetal screw		4	
28		Washer 5,3		4	
29	N 021 196 1	Lock nut M 5		4	
29	N 021 196 3	Hexagon nut M 5		4	
-	999 591 379 02	Cable clamp		4	
-	999 591 379 01	Cable clamp		4	
32	911 631 939 00	Tail light housing	/L	1	
(32)	911 631 940 00	Tail light housing	/R	1	
-	N 100 818 01	Oval-head screw for Tail light housing M5 X 16		X	
34	911 631 949 00	Rear light Lens	/L	1	
-	PCG 631 911 00	Screw Fastening screw Silver Comprising: 6 Schrauben 6 Dichtungen		1	
-	PCG 631 911 01	Screw Fastening screw Black		1	

Model: 911 78 Model life 1978>>1983

Pos	Part Number	Description	Remark	Qty	Model
(34)	911 631 950 00	Comprising: 6 Schrauben 6 Dichtungen Lens Rear light	/R	1	
-	PCG 631 911 00	Screw Fastening screw Silver		1	
-	PCG 631 911 01	Comprising: 6 Schrauben 6 Dichtungen Screw Fastening screw Black		1	
35	911 631 971 01	Comprising: 6 Schrauben 6 Dichtungen Gasket Rear light	/L	1	
(35)	911 631 971 00	Gasket Rear light	/R	1	
36	999 507 312 12	Nut lock M 5		4	
36	999 507 330 02	Cable holder M 5		4	
36	999 507 312 12	Nut lock M 5		4	
37	911 631 432 03	Covering with Reflector		1	
(37)	911 631 432 02	Covering without Reflector		1	TURBO
37A	999 591 447 02	Cage		10	
42	930 633 101 01	Reflector		2	TURBO
42	930 633 101 02	Reflector		2	TURBO

Model: 911 78

Model life 1978>>1983

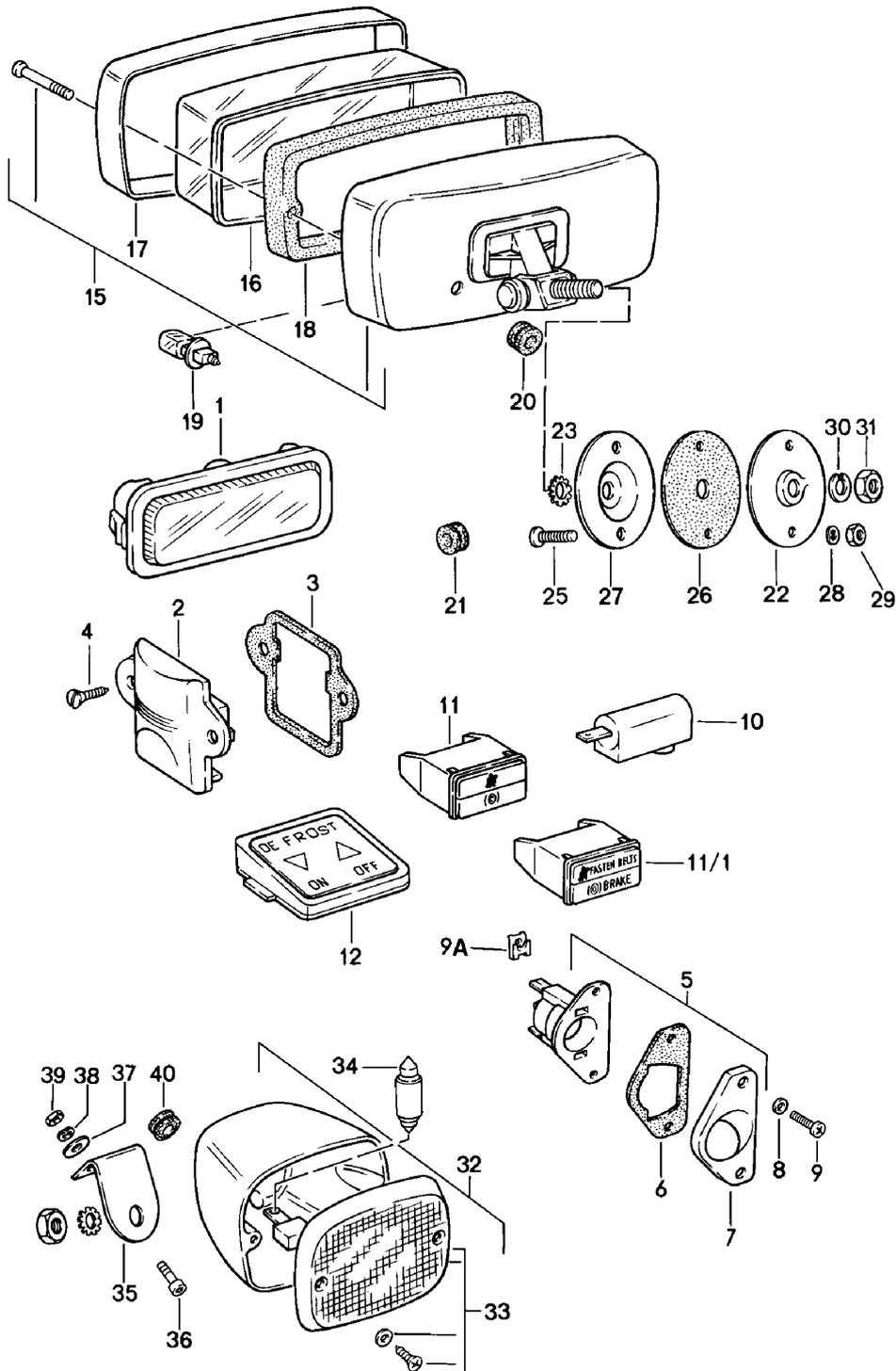

Model: 911 78

Model life 1978>>1983

Pos	Part Number	Description	Remark	Qty	Model
1	901 632 101 28	Interior lights Fog headlamp		2	SC, COUPE
(1)		Interior light		2	TURBO
(1)	911 632 102 00	Interior light		1	TARGA
-	964 555 153 00	Light Desk pad		2	SC, COUPE
		Interior light 901.632.101.00			
2	901 632 201 01	Luggage compartment lamp		1	
3	901 632 291 00	Desk pad		1	
4	N 013 961 2	Luggage compartment lamp Oval-head sheetmetal screw B 3,9 X 13		2	
4	N 013 961 11	Oval-head sheetmetal screw B 3,9 X 13		2	
5	911 631 620 04	License plate light		2	
6	911 631 608 00	Gasket License plate light		2	
6	911 631 608 01	Gasket License plate light		2	
7	911 631 606 00	Lens		2	
8	911 631 604 00	Sealing washer		4	
9	900 146 041 07	Oval-head screw BM 3 X 15		4	
-	999 591 381 02	Cable clamp		2	
-	999 591 381 01	Cable clamp		2	
10	911 632 904 00	Ashtray light		1	
11	911 632 013 03	Indicator light Double Seat belt Brake	/LL	1	
11/1	911 632 013 05	Indicator light Double Handbrake Brake	/RL	1	
-	911 632 116 01	Grommet for Indicator light Double		1	
15	911 631 206 03	Fog headlamp Housing Black		2	
(15)	911 631 206 04	Fog headlamp Housing Black Light-diffusing lens Yellow		2	
16	911 631 964 00	Light-diffusing lens for 911.631.206.03		2	
(16)	911 631 963 00	Light-diffusing lens for 911.631.206.04		2	
17	911 631 959 28	Ring for fog headlamp Black		2	
18	911 631 956 00	Gasket		2	
19	900 631 126 90	Halogen bulb H 3		2	
20	999 702 084 50	Rubber sleeve		2	
21	911 612 132 00	Grommet		2	
22	911 631 060 01	Tensioning plate Inner		2	
23	900 114 011 01	Shake-proof washer		2	

Model: 911 78

Model life 1978>>1983

Pos	Part Number	Description	Remark	Qty	Model
25	900 067 009 02	A 10,5 Pan-head screw		4	
25	900 067 429 01	M 6 X 16 Pan-head screw		4	
26	911 631 151 01	M 6 X 16 Rubber base		2	
27	911 631 150 01	Tensioning plate		2	
28	N 012 226 5	Outer Spring washer		4	
29	900 076 010 02	A 6 Nut		4	
29	900 076 010 0B	M 6 Nut		4	
30	900 027 016 02	M 6 Lock ring		2	
30	900 027 016 03	B 10 Lock ring		2	
31	900 027 015 02	B 10 Lock ring		2	
31	900 027 015 03	M 10 Lock ring		2	
32	911 631 251 29	M 10 Rear fog light		2	
33	911 631 975 00	Rear fog light		2	
34	900 631 127 90	Lens		2	
35	911 631 125 02	Bulb		2	
36	900 067 117 07	12 V - 21 W Fastening angle		1	
37	N 011 666 7	Pan-head screw		4	
38	N 012 006 4	M 6 X 16 Washer		4	
39	900 076 010 07	B 6,4 Lock ring		4	
40	999 702 020 50	B 6 Hexagon nut		2	
-	999 703 066 50	Rubber sleeve		1	
-	999 652 208 10	8 X 12 X 9 Stopper		2	
-	999 591 381 02	Cable shoe		6	
-	999 591 381 01	for Rear fog light		6	
-	999 703 067 50	Cable clamp		1	
-	911 631 315 01	Cable clamp		1	
-	999 631 202 90	Stopper		2	
-	999 631 202 91	Engine compartment lamp		2	
-	900 631 126 90	Bulb		2	
-	900 631 127 90	H 4 12 V - 60/55 W Halogen bulb	(F)	2	
-	900 631 128 90	H 4 12 V - 60/55 W Yellow		2	
-	900 631 103 90	Halogen bulb		2	
-	900 631 115 90	H 3 Bulb		1	
-	900 631 106 90	12 V - 21 W Bulb		2	
-	900 631 102 90	12 V - 21/5 W Bulb	(DK) (I) (N)	2	(J)
-	900 631 102 90	12 V - 4 W Bulb		1	
-	900 631 106 90	12 V - 10 W Linolite lamp		3	
-	900 631 102 90	12 V - 10 W Light	-80	X	

Model: 911 78

Model life 1978>>1983

Pos	Part Number	Description	Remark	Qty	Model
-	900 631 132 90	12 V - 2 W Bulb		X	
-	900 631 123 90	12 V - 1,2 W Linolite lamp		2	
-	900 631 123 92	12 V - 18 W Linolite lamp		2	
-	900 631 104 90	12 V - 18 W Bulb 12 V - 5 W		2	

Model: 911 78

Model life 1978>>1983

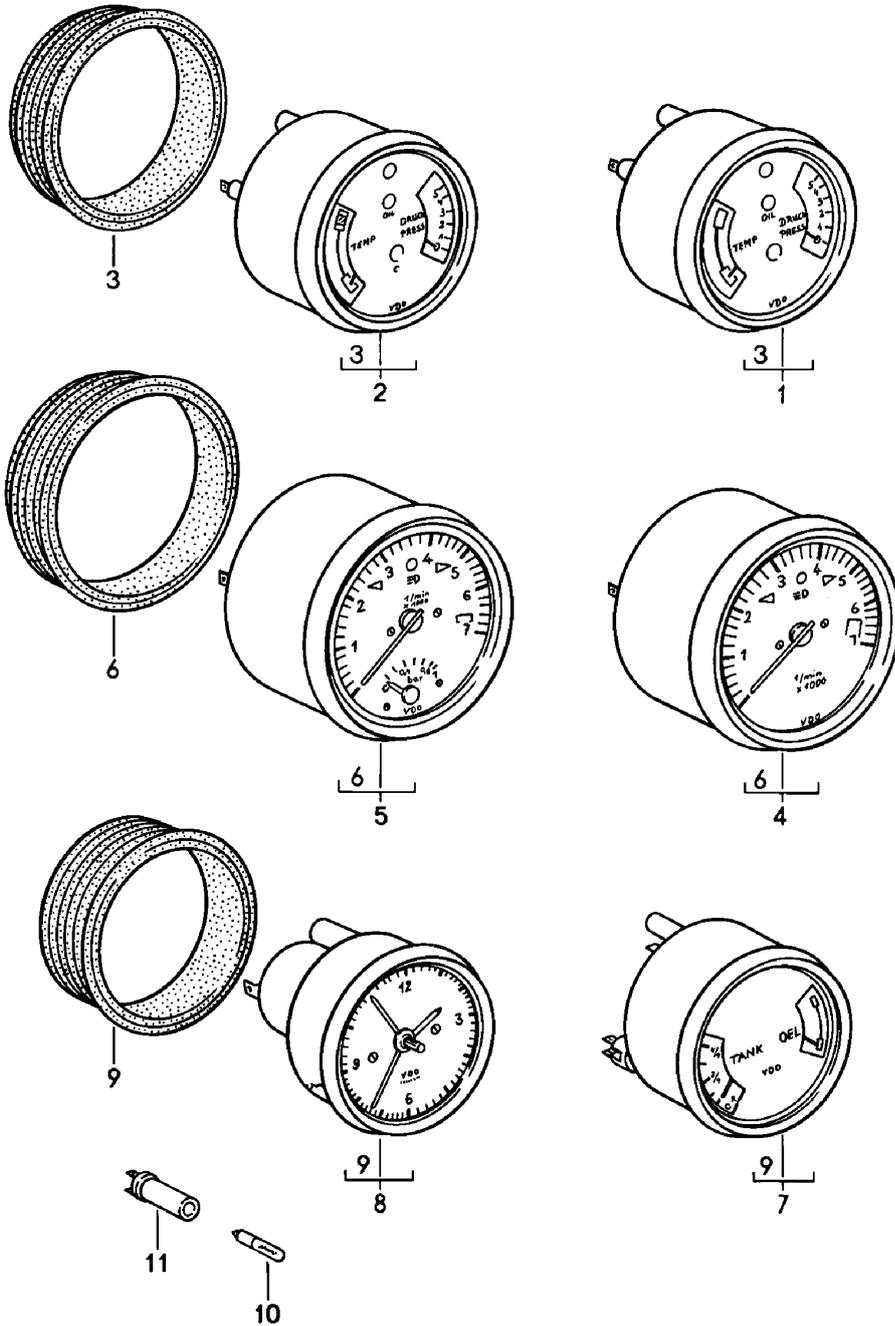

Model: 911 78 Model life 1978>>1983

Pos	Part Number	Description	Remark	Qty	Model
		Instruments			
1	911 641 103 03	Instrument cluster 100 \$	-81	1	
1	911 641 103 CX	Instrument cluster 100 \$		1	
(1)	911 641 923 00	Instrument cluster 100 \$	82-	1	
(1)	911 641 923 X	Instrument cluster 100 \$	82-	1	
2	911 641 105 03	Instrument cluster 100 \$	SPM	1	
2	911 641 105 CX	Instrument cluster 100 \$	SPM	1	
3	911 641 902 00	Rubber ring 100 \$		2	
4	911 641 301 03	Tachometer		1	SC
4	911 641 301 CX	Tachometer 115 \$		1	SC
5	930 641 302 01	Tachometer with Boost pressure gauge 115 \$		1	TURBO
6	911 641 903 00	Rubber ring 115 \$		2	
7	911 641 202 03	Instrument cluster 80 \$		1	
7	911 641 202 DX	Instrument cluster 80 \$		1	
8	911 641 701 29	Clock 80 \$		1	
9	911 641 901 00	Rubber ring 80 \$		2	
10	900 631 102 90	Light for Illumination 12 V 2 W	-80	X	
-	900 631 132 90	Bulb	81-	X	
-	900 631 103 90	Bulb Indicator light Generator	82-	1	
11	999 632 007 00	Bulb socket - 1 - Terminal clamp		X	
(11)	999 632 009 10	Bulb socket Small - 2 - Terminal clamp		1	
(11)	999 632 002 00	Bulb socket - 2 - Terminal clamp	82-	1	
-	911 612 047 00	Wiring harness for Illumination Instruments		1	
-	999 652 161 10	Tubular rivet for 999.632.003.00		8	

Model: 911 78

Model life 1978>>1983

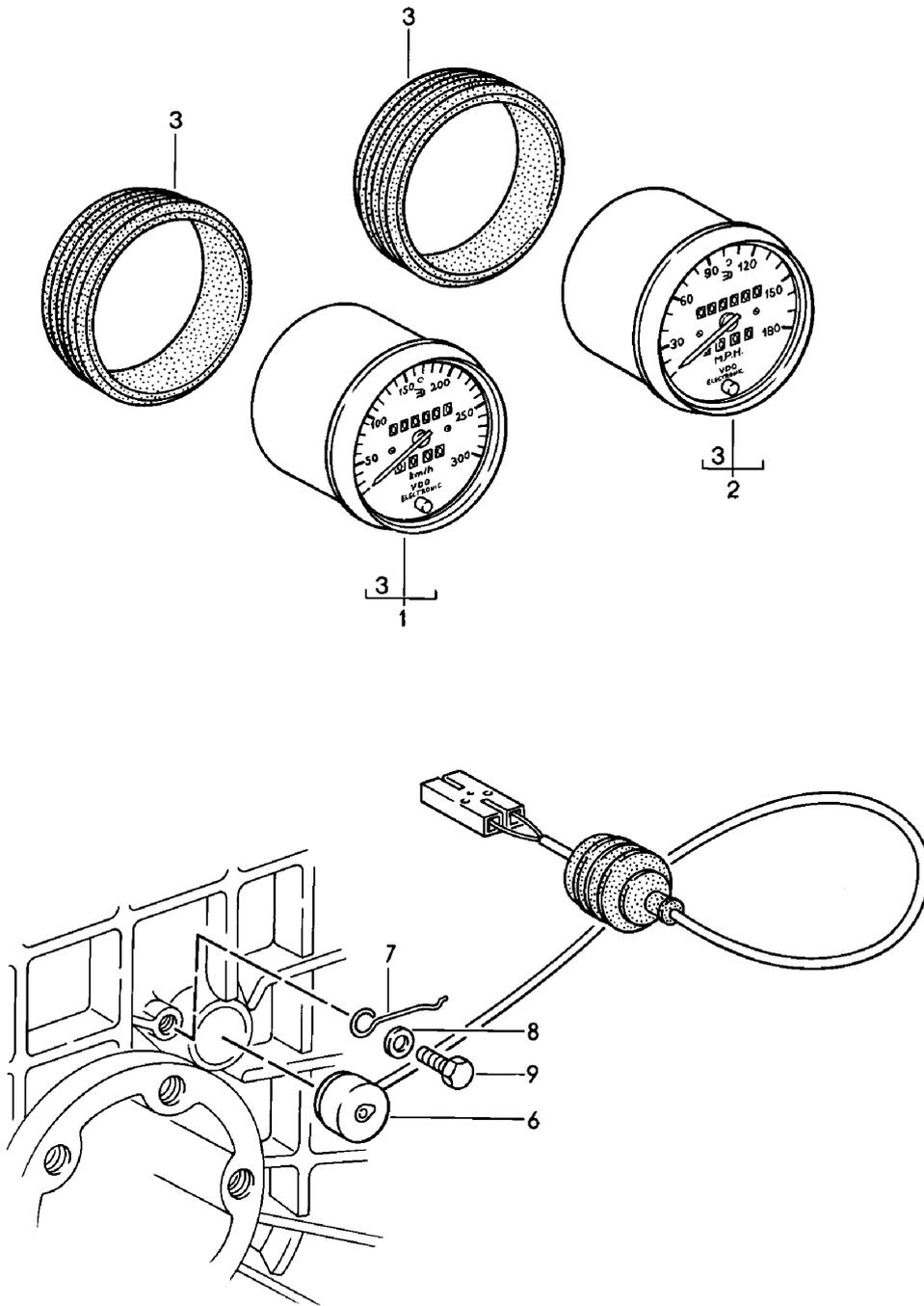

Model: 911 78 Model life 1978>>1983

Pos	Part Number	Description	Remark	Qty	Model
(1)	911 641 516 01	Speedometer		1	SC
(1)	911 641 516 AX	Speedometer		1	SC
		250 KM/H			
1	930 641 507 01	Speedometer		1	TURBO
1	930 641 507 AX	Speedometer		1	TURBO
		300 KM/H			
2	930 641 508 00	Speedometer	-79	1	
		150 MPH			
(2)		Speedometer		1	
(2)	930 641 508 X	Speedometer		1	
		170 MPH + 270 KM/H			
3	911 641 902 00	Rubber ring		4	
		100 \$			
6	911 606 209 00	Pulse sender		1	
7	915 660 509 00	Tensioning spring		1	
8	N 011 524 7	Washer		1	
		6,4			
8	N 011 524 27	Washer		1	
		6,4			
9	999 072 005 09	Hexagon nut		1	
		M 6 X 12			
9	999 072 005 01	Hexagon nut		1	
		M 6 X 12			
-	911 612 406 01	Cable holder		1	
-	900 093 010 02	Grooved nail		1	
		3 X 8			
-	999 513 002 40	Tie-wrap		1	TURBO
-	N 020 910 4	Tie-wrap		1	TURBO
-	999 513 003 40	Tie-wrap		1	TURBO

Model: 911 78

Model life 1978>>1983

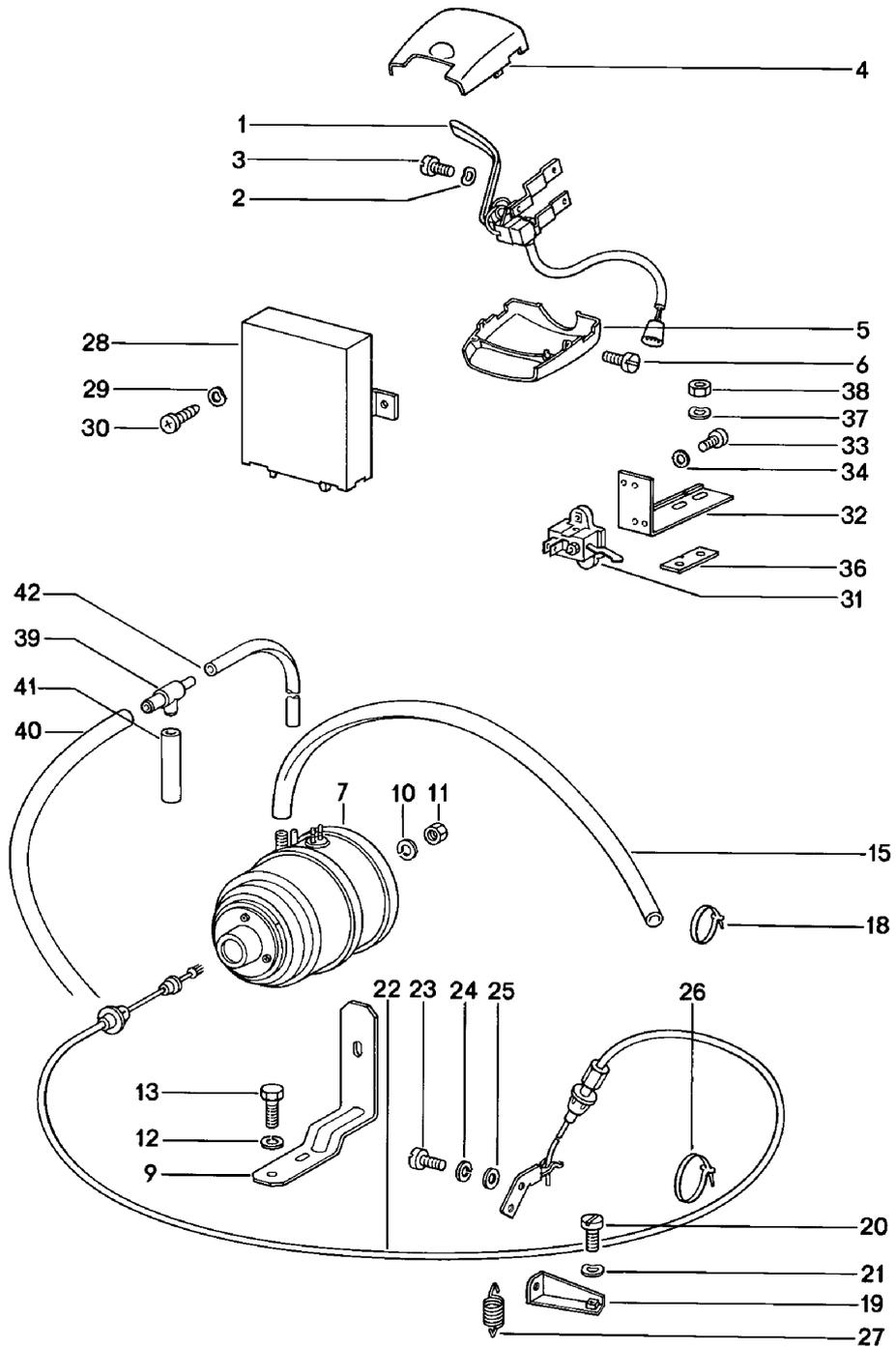

Model: 911 78

Model life 1978>>1983

Pos	Part Number	Description	Remark	Qty	Model
1	911 613 102 01	Cruise control Switch		1	
2	900 115 007 01	Serrated lock washer 3,2		2	
3	900 014 079 02	Pan-head screw M 3 X 10		2	
4	911 613 311 02	Switch housing Upper part		1	
5	911 613 312 02	Switch housing Lower part		1	
6	900 014 079 02	Pan-head screw M 3 X 10		2	
7	911 617 123 02	Drive link Cruise control		1	
9	911 617 127 00	Support		1	
10	900 027 015 02	Lock ring B 8		1	
10	900 027 015 03	Lock ring B 8		1	
11	900 076 025 02	Hexagon nut M 8		1	
11	900 076 064 02	Hexagon nut M 8		1	
12	N 012 006 4	Lock ring B 6		2	
13	999 072 005 09	Hexagon nut M 6 X 12		2	
13	999 072 005 01	Hexagon nut M 6 X 12		2	
-	N 020 359 1	Hose C 9 X 15		*	
15		670 MM		1	
18	999 513 010 40	Tie-wrap 140 MM Long		1	
19	911 110 226 00	Retaining bracket		1	
20	900 071 005 02	Oval-head screw M 5 X 10		1	
21	N 012 222 4	Spring washer B 5		1	
22	911 617 124 01	Bowden cable	-80	1	
(22)	911 617 124 02	Bowden cable	81-	1	
23	N 014 128 13	Oval-head screw M 5 X 8		2	
24	N 012 005 3	Lock ring A 5		2	
25	900 025 003 02	Washer A 5,3		2	
26	999 513 010 40	Tie-wrap 250 MM Long		2	
27	911 110 227 00	Gas prop		1	
28	928 617 127 00	Cruise control regulator		1	
29	N 012 222 4	Spring washer B 5	/LL	2	
30	999 217 008 02	Hexagon-head bolt M 5 X 10	/LL	2	
-	999 507 028 02	Speed nut B 4,2	/RL	1	
-	900 143 007 02	Oval-head sheetmetal screw B 4,2	/RL	1	
-	900 073 507 01	Oval-head sheetmetal screw B 4,2	/RL	1	

Model: 911 78

Model life 1978>>1983

Pos	Part Number	Description	Remark	Qty	Model
31	911 613 411 00	Brake light switch		1	
31	911 613 411 01	Brake light switch		1	
32	911 613 131 00	Support		1	
33	900 146 011 02	Oval-head screw M 4 X 10		2	
34	900 114 014 01	Shake-proof washer A 4,3		2	
36	911 613 132 00	Plate		1	
37	N 012 226 5	Spring washer B 6		2	
38	900 076 010 02	Nut M 6		2	
38	900 076 010 0B	Nut M 6		2	
39	911 110 228 00	T-reducer		1	
-	N 020 359 1	Hose C 9 X 15		*	
41		45 MM		1	
40		130 MM		1	
-	999 181 167 50	Hose C 4,5 X 9,5		*	
42		500 MM		1	
-	911 612 157 07	Wiring harness Cruise control regulator Tunnel	/LL	1	
-	911 612 157 06	Wiring harness Cruise control regulator Tunnel	/RL	1	
-	911 612 158 01	Wiring harness Tunnel		1	
-	911 612 156 02	Drive link Wiring harness		1	SPM

Model: 911 78

Model life 1978>>1983

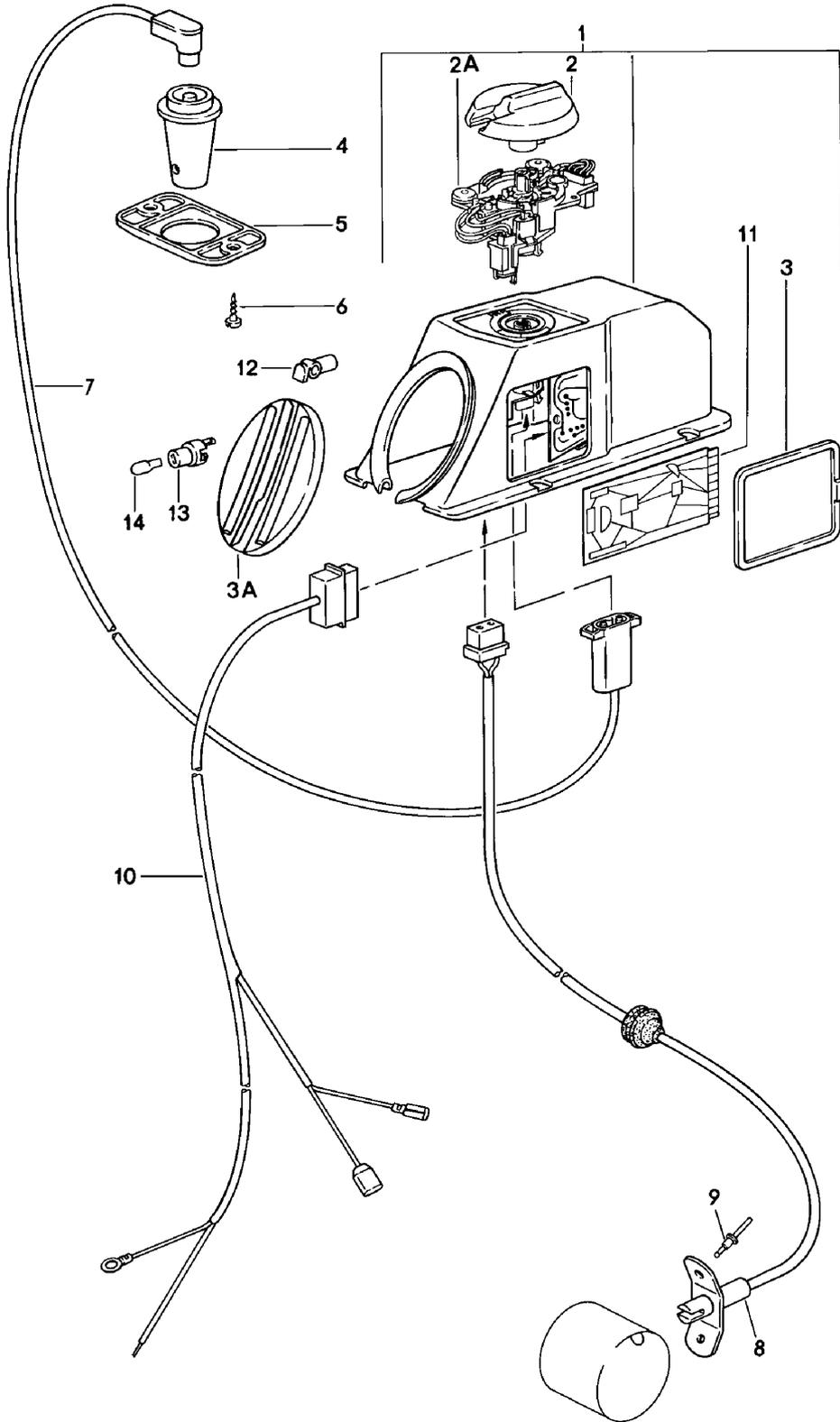

Model: 911 78 Model life 1978>>1983

Pos	Part Number	Description	Remark	Qty	Model
		Heating Automatic			
1	911 659 049 01	Control mechanism		1	
2	911 659 110 00	Knob		1	
2A	911 659 908 00	Switch		1	
3	911 659 108 00	Lid		2	
3A	911 424 591 05	Sleeve		1	
4	911 659 105 01	Interior sensor		1	
5	911 571 235 01	Rosette		1	
6	900 143 065 07	Tapping screw B 2,9 X 9,5		2	
6	900 073 003 01	Tapping screw B 2,9 X 9,5		2	
7	911 612 150 00	Wiring harness Interior sensor		1	
8	911 659 101 00	Caloric feeler		1	
(8)	911 659 101 01	Caloric feeler		1	
-		Connecting piece See group 2/02/00			
9	999 190 129 02	Blind rivet		2	
10	911 612 152 00	Wiring harness	/LL	1	
(10)	911 612 152 01	Wiring harness	/RL	1	
-	N 012 225 2	Spring washer B 5		4	
-	900 075 154 07	Hexagon-head bolt M 5 X 18		4	
11	911 659 058 02	Printed circuit board		1	
12	999 168 021 40	Ball socket		2	
13	914 631 179 10	Bulb socket		1	
14	900 631 132 90	Bulb 12 V - 1,2 W		1	

Model: 911 78

Model life 1978>>1983

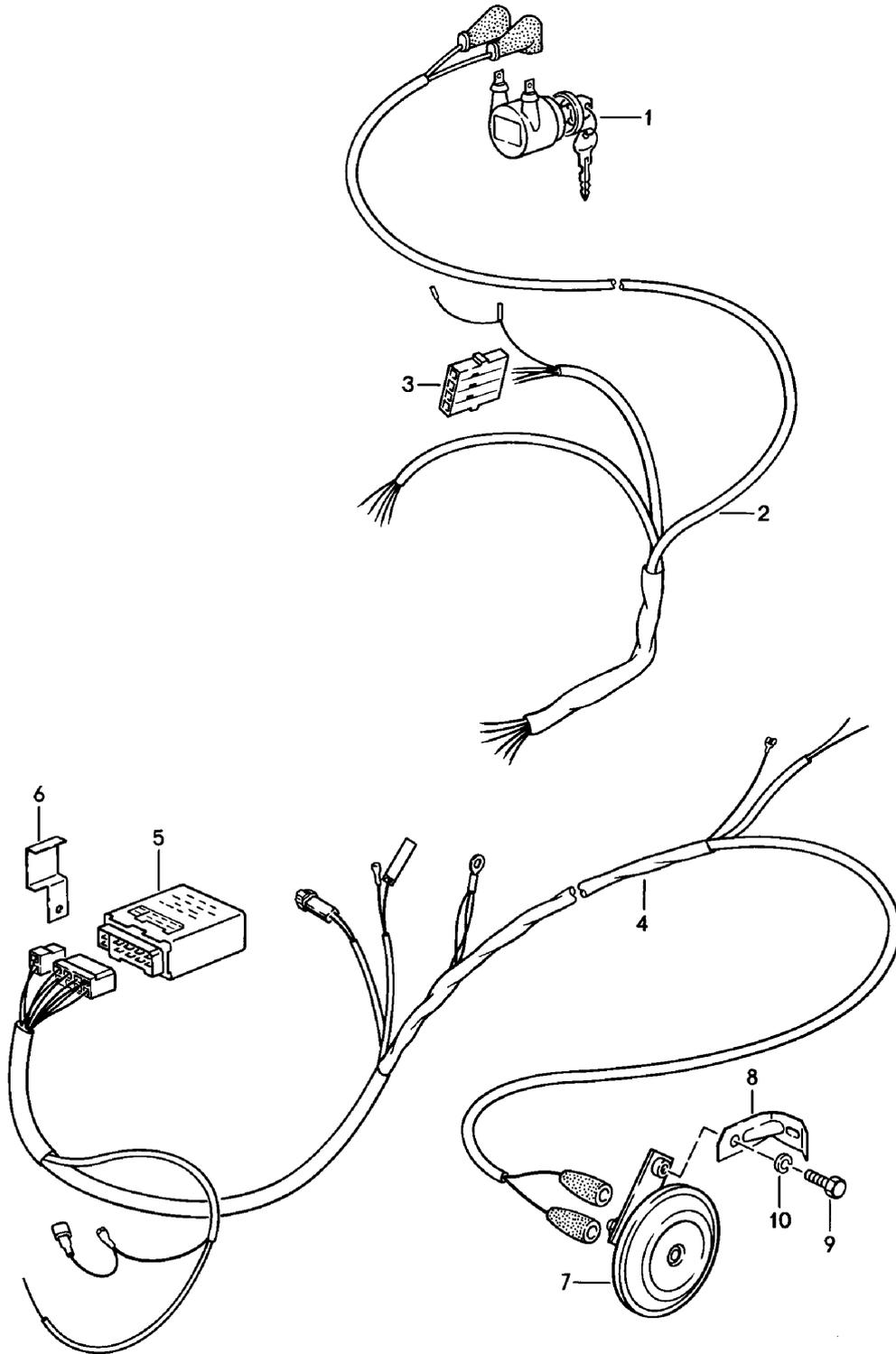

Model: 911 78 Model life 1978>>1983

Pos	Part Number	Description	Remark	Qty	Model
1	911 637 101 00	Alarm system Left-hand drive Alarm switch with 2 Key		1	
2	911 612 163 02	Wiring harness Passenger's door without Spiegel	/L	1	
(2)	911 612 165 02	Wiring harness Passenger's door with Spiegel	/L	1	
3	111 971 977	Flat connector socket		1	
4	911 612 176 01	Wiring harness		1	
5	911 637 104 00	Alarm control unit		1	
(5)	911 637 104 01	Alarm control unit	(CH)	1	
6	911 637 117 00	Support		1	
7	944 637 103 01	Horn		1	
8	911 635 093 00	Retaining bracket		1	
9	N 010 239 11	Hexagon-head bolt M 8 X 18		1	
9	N 010 239 30	Hexagon-head bolt M 8 X 18		1	
10	900 027 015 02	Lock ring B 8		1	
10	900 027 015 03	Lock ring B 8		1	

Model: 911 78

Model life 1978>>1983

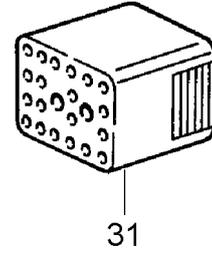
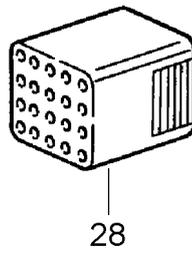
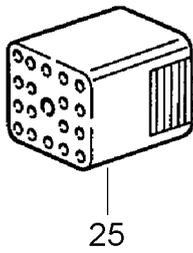
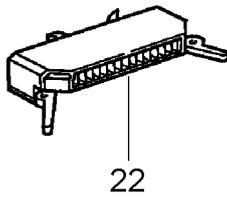
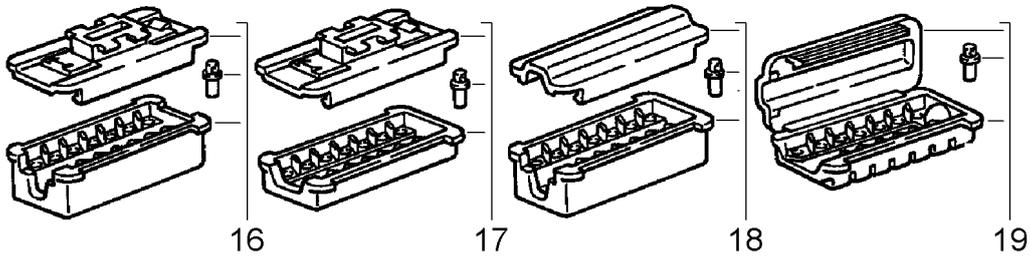
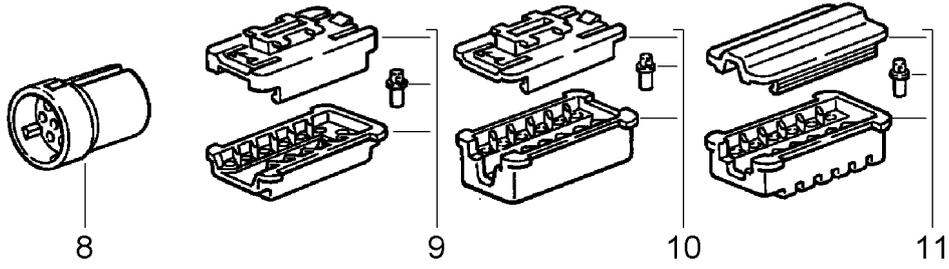
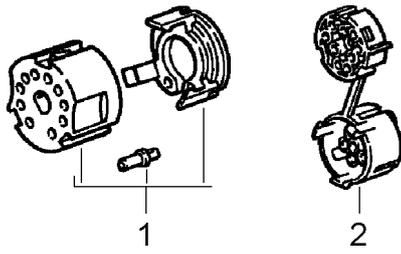

Model: 911 78

Model life 1978>>1983

Pos	Part Number	Description	Remark	Qty	Model
		Connector housing 10-pole Until 22-pole 10-pole			
1	911 612 889 00	Connector housing with		X	
-		Contact bush		10	
2	944 613 531 01	Connector housing for		X	
-	944 612 548 00	Contact bush 12-pole		10	
8	861 972 524	Connector housing 1,6 / 3,5		X	
9	911 612 122 02	Plug socket with		X	
		Contact bush		12	
9	911 612 122 04	Plug socket with		X	
		Contact bush		12	
10	928 612 423 00	Connector housing		X	
11	911 612 884 00	Connector housing		X	
11	911 612 121 01	Connector housing 14-pole		X	
16	911 612 115 02	Connector housing		X	
17	911 612 113 05	Connector housing		X	
18	911 612 115 03	Connector housing		X	
19	944 612 215 00	Connector housing without		X	
		Contact bush 99965235122 17-pole		14	
22	944 612 311 00	Connector housing for		X	
-	999 652 380 12	Contact spring 19-pole		X	
25	171 971 971 C	Connector housing Nature		X	
(25)	171 971 971 E	Connector housing White		X	
		20-pole			
28	171 971 971	Connector housing Yellow		X	
(28)	171 971 971 D	Connector housing Red		X	
		22-pole			
31	171 971 971 A	Connector housing Black		X	
(31)	171 971 971 B	Connector housing Blue		X	

Model: 911 78

Model life 1978>>1983

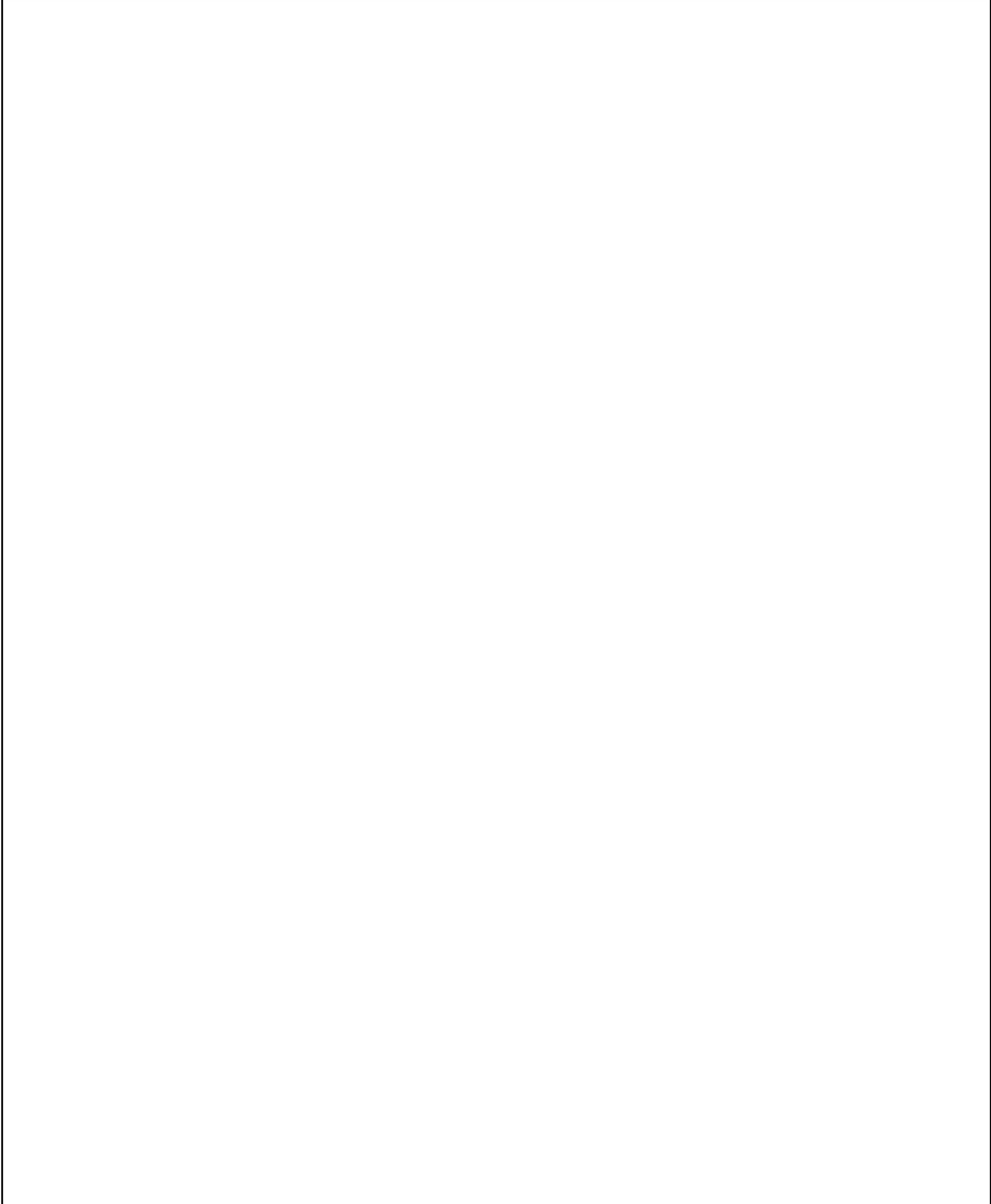

Model: 911 78

Model life 1978>>1983

Pos	Part Number	Description	Remark	Qty	Model
>>	911 631 993 00	Oval-head sheetmetal screw Fog headlamp White 1 set for subsequent installation	4,8 X 9	1	
-	911 631 206 03	Fog headlamp White		2	
-	999 702 084 50	Rubber sleeve		2	
-	911 612 132 00	Grommet		2	
-	900 114 011 01	Shake-proof washer A 10,5		2	
-	911 631 060 01	Tensioning plate Outer		2	
-	911 631 151 01	Rubber base		2	
-	911 631 150 01	Tensioning plate Inner		2	
-	900 067 009 02	Pan-head screw M 6 X 16		4	
-	900 067 429 01	Pan-head screw M 6 X 16		4	
-	N 012 226 5	Spring washer A 6		4	
-	900 076 010 02	Nut M 6		4	
-	900 076 010 0B	Nut M 6		4	
-	900 027 016 02	Lock ring B 10		2	
-	900 027 016 03	Lock ring B 10		2	
-	N 011 010 6	Hexagon nut M 10		2	
-	N 101 552 10	Hexagon nut M 10		2	
-	911 612 027 03	Additional cables		1	
-	901 612 064 00	Ground cable		1	
-	901 612 066 02	Wiring harness for Switch		1	
-	911 615 109 01	Standard type relay		1	
-	902 613 623 90	Switch		1	
-	999 703 067 50	Stopper		1	
-	911 613 213 02	Rosette		1	
-	900 631 132 90	Bulb 12 V - 2 W		1	
-	911 613 215 02	Knob		1	
>>	911 631 993 01	Fog headlamp Yellow 1 set for subsequent installation	(F)	1	
-	911 631 206 04	Fog headlamp Yellow		2	
-	999 702 084 50	Rubber sleeve		2	
-	911 612 132 00	Grommet		2	
-	900 114 011 01	Shake-proof washer A 10,5		2	
-	911 631 060 01	Tensioning plate Outer		2	
-	911 631 151 01	Rubber base		2	
-	911 631 150 01	Tensioning plate Inner		2	

Model: 911 78

Model life 1978>>1983

Pos	Part Number	Description	Remark	Qty	Model
-	N 012 226 5	Spring washer A 6		4	
-	900 076 010 02	Nut M 6		4	
-	900 076 010 0B	Nut M 6		4	
-	900 027 016 02	Lock ring B 10		2	
-	900 027 016 03	Lock ring B 10		2	
-	N 011 010 6	Hexagon nut M 10		2	
-	N 101 552 10	Hexagon nut M 10		2	
-	911 612 027 03	Additional cables		1	
-	901 612 064 00	Ground cable		1	
-	901 612 066 02	Wiring harness		1	
-	911 615 109 01	Standard type relay		1	
-	902 613 623 90	Switch		1	
-	999 703 067 50	Stopper		1	
-	911 613 213 02	Rosette		1	
-	900 631 132 90	Bulb 12 V - 2 W		1	
-	911 613 215 02	Knob		1	